



WINDOW TECHNOLOGY  
DOOR TECHNOLOGY  
AUTOMATIC ENTRANCE SYSTEMS  
BUILDING MANAGEMENT SYSTEMS



WINDOW TECHNOLOGY – ORDER CATALOG | SECTION 02.1



## Casement & Awning Windows Hardware



Securing technology for you







# 02.1

## Casement & Awning Windows Hardware

SS Dyad and Dual Arm Operator .....	02.1.5
Covers & Fold-in Handles.....	02.1.6
SS Track and Brackets for Casement Operators .....	02.1.7
Awning SS Operator and Track .....	02.1.8
Covers & Fold-in Handles for awning & casement.....	02.1.9
Casement and Awning Hinges .....	02.1.10
Accessories For Hinges .....	02.1.12
<b>Multipoint</b> Locking Handles.....	02.1.13
Single point Locking Handles.....	02.1.15
Multipoint Locking Bars & Half Reaching Wedge .....	02.1.17
Guide Shims for Multipoint Locking Bars .....	02.1.20
Keepers for Multipoint Locking Bars .....	02.1.21
Single Point Keepers .....	02.1.23
Restrictors .....	02.1.24
Accessories.....	02.1.25

# Left/Right Hand Identification

for Casement Window Hardware

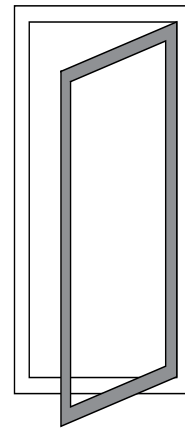
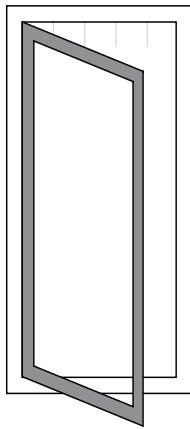

## OUTSWING WINDOWS (VIEWED FROM OUTSIDE)

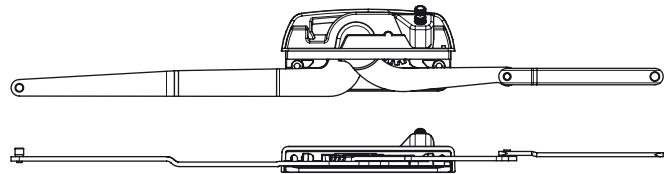
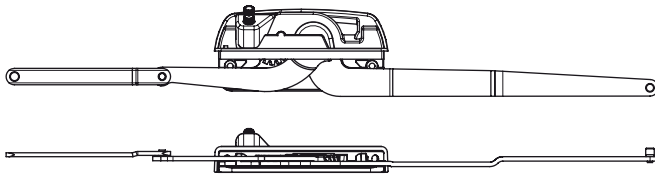

### LEFT-HAND DUAL ARM OPERATOR

6-C2331-00-L-8  
(use cover kit type A)

### RIGHT-HAND DUAL ARM OPERATOR

6-C2331-00-R-8  
(use cover kit type B)

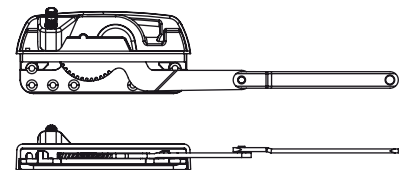
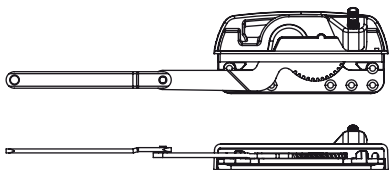

### LEFT-HAND DYAD OPERATOR

6-C2332-00-L-8  
(use cover kit type B)

### RIGHT-HAND DYAD OPERATOR

6-C2332-00-R-8  
(use cover kit type A)

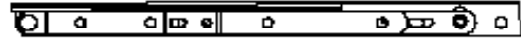
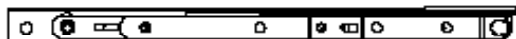

### CASEMENT HINGES

6-C2431-XX-A/B-8B  
6-C2480-XX-A/B-8B  
(For this window position, use type A)

### CASEMENT HINGES

6-C2431-XX-A/B-8B  
6-C2480-XX-A/B-8B  
(For this window position, use type B)



**HALF REACHING WEDGE (A)**  
9-C0148-00-A-6



**HALF REACHING WEDGE (B)**  
9-C0148-00-B-6

# Dyad and Dual Arm Stainless Steel Operators

with Removable Cover and Fold-in Handle

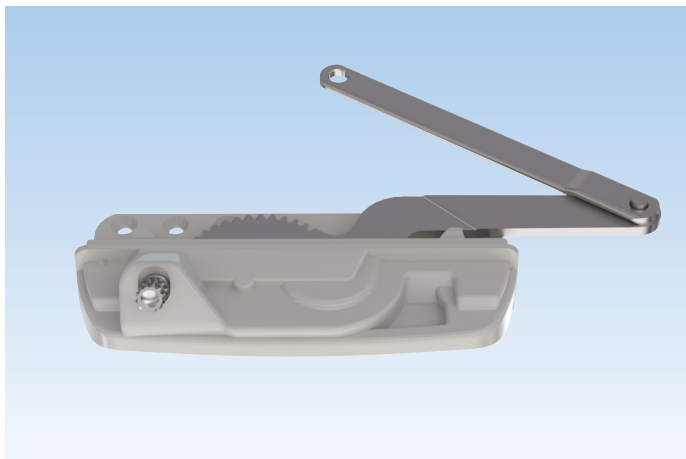

## Dyad Operator

Description	Color	PU	Part Number
Operator for casement windows	SS	20	6-C2332-00-L/R-8
Operator for casement windows with short arm	SS	20	6-C2332-MC-L/R-8

L/R = Left-handed/Right-handed

PU = Packaging Unit

### Additional information

- Tempered stainless steel arms
- Powder coated base made of "Zamak"
- Industry standard cutouts
- AAMA Compliance
- Used with covers:
  - left-handed (L) use cover kit type B
  - right-handed (R) use cover kit type A

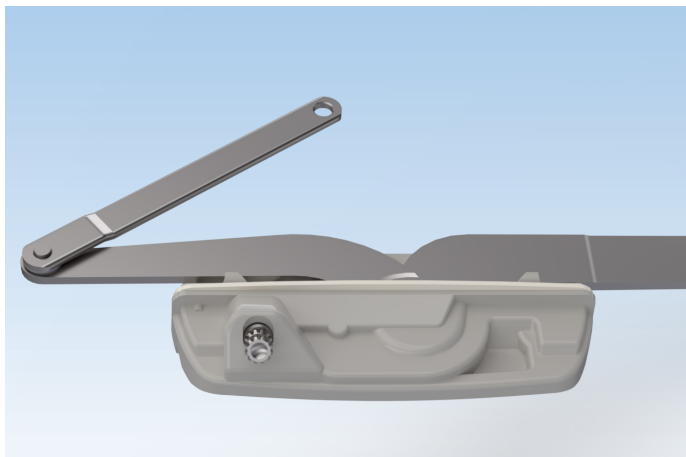

## Dual Arm Operator

Description	Color	PU	Part Number
Operator for casement windows	SS	20	6-C2331-00-L/R-8
Operator for casement windows with short arm	SS	20	6-C2331-MC-L/R-8

L/R = Left-handed/Right-handed

PU = Packaging Unit

### Additional information

- Tempered stainless steel arms
- Powder coated base made of "Zamak"
- Industry standard cutouts
- Minimum frame width 533,4mm (21")
- AAMA Compliance
- Used with covers:
  - left-handed (L) use cover kit type A
  - right-handed (R) use cover kit type B

# Removable cover and Fold-in Handle

For Casement

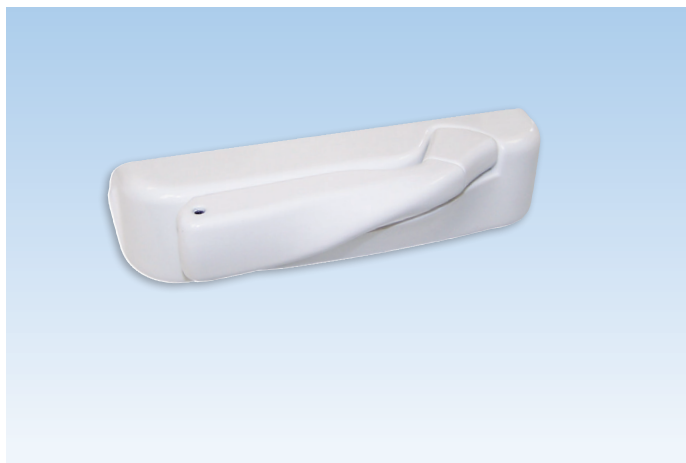

## FENIX CLASSIC Removable Cover & Fold-in Handle kit

Description	PU	Part Number
Kit type A	100	6-C2345-02-A-*
Kit type B	100	6-C2345-02-B-*
* = Color		PU = Packaging Unit
7 = White, 27 = Blue White, 6 = Black		6



### Additional information

- Once the window is closed, the handle folds and snaps into the cover once the window is closed

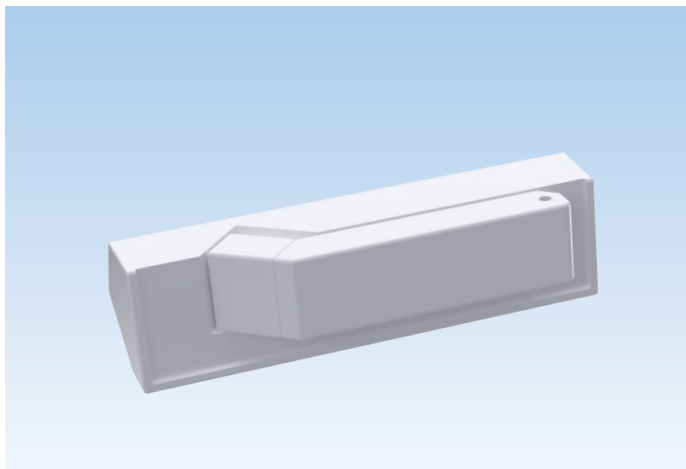

## FENIX EVO Removable Cover & Fold-in Handle kit

Description	PU	Part Number
Kit type A	10	6-C2350-00-A-*
Kit type B	10	6-C2350-00-B-*
* = Color		PU = Packaging Unit
7 = White, 27 = Blue White, 6 = Black		

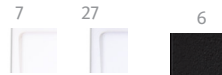

### Additional information

- Once the window is closed, the handle folds and snaps into the cover once the window is closed

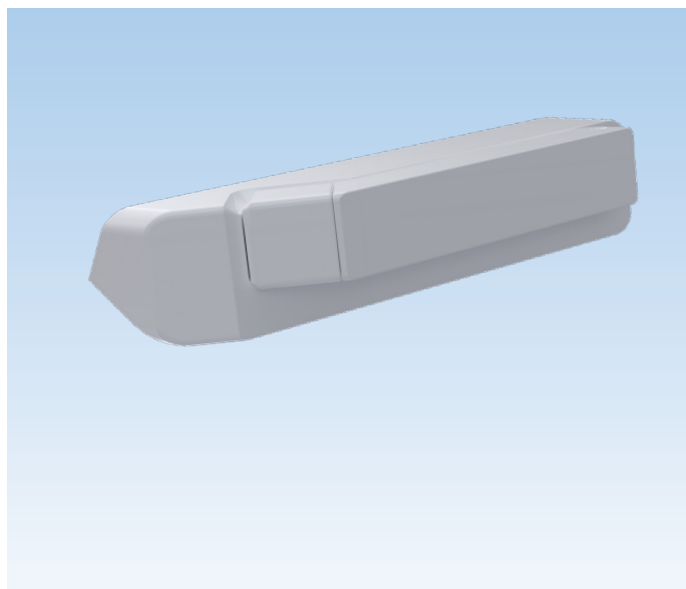

## FENIX EVO 2 Removable Cover & Fold-in Handle kit

Description	PU	Part Number
Kit type A	10	6-C2352-00-A-*
Kit type B	10	6-C2352-00-B-*
* = Color		PU = Packaging Unit
7V = Matte White, 27V = Matte Blue White, 6V = Matte Black		



### Additional information

- Once the window is closed, the handle folds and snaps into the cover once the window is closed

# Stainless Steel Track and Brackets

For Casement

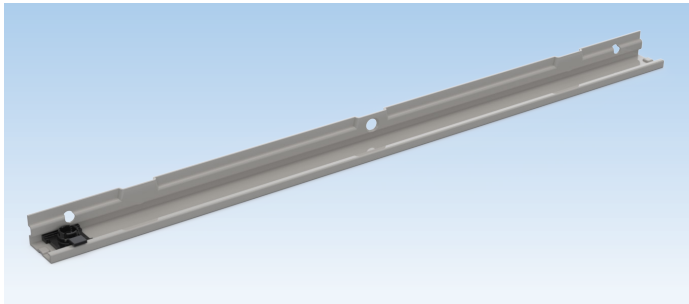

### Track for Dual Arm Operator

Description	Color	PU	Part Number
Track with slider guide	SS	200	6-C2336-00-0-8
PU = Packaging Unit			

#### Additional information

- Made of stainless steel
- Recommended to use SS screws 9-C9681-00-0-8 or 9-C9686-00-0-8 for installation

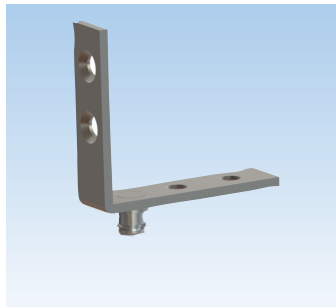

### 90° Bracket

Description	Color	PU	Part Number
Bracket for casement operators	SS	200	6-C2320-00-0-8
PU = Packaging Unit			

#### Additional information

- Made of stainless steel
- Snap-on pivot
- Recommended to use SS screws 9-C9681-00-0-8 or 9-C9686-00-0-8 for installation

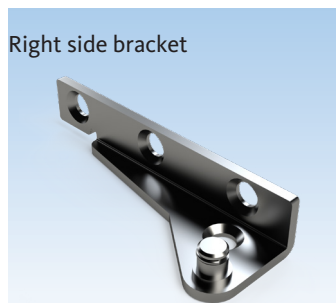

Right side bracket

### Surface mounted stud bracket

Description	Color	PU	Part Number
25 mm stud bracket	SS	200	6-C2307-00-L/R-8B
PU = Packaging Unit			

#### Additional information

- Made of stainless steel
- Snap-on pivot
- Recommended to use SS screws 9-C9681-00-0-8 or 9-C9686-00-0-8 for installation

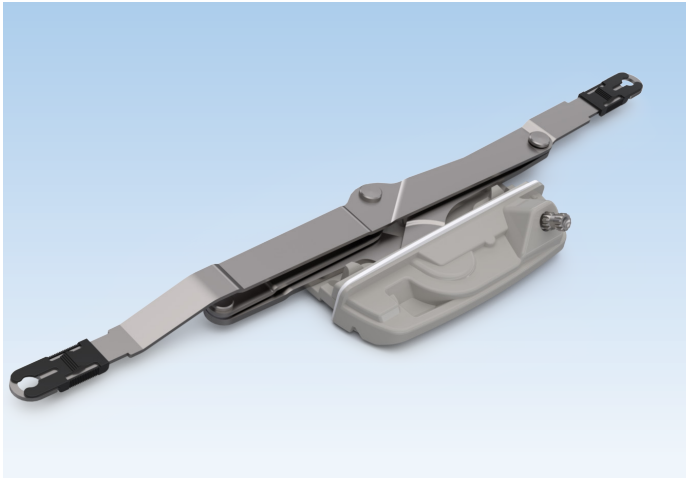

### Scissor Arm Operator

Description	Color	PU	Part Number
Operator for awning windows	SS	20	6-C2340-00-0-8
PU = Packaging Unit			

#### Additional information

- Tempered stainless steel arms
- Powder coated base made of "Zamak"
- Industry standard cutouts
- AAMA Compliance
- Used with cover kit type A



### Track for Scissor Arm Operator

Description	Color	PU	Part Number
Track with slider guides	SS	40	6-C2335-01-0-8
PU = Packaging Unit			

#### Additional information

- Made of stainless steel
- Two slider guides included
- Recommended to use SS screws 9-C9681-00-0-8 or 9-C9686-00-0-8 for installation



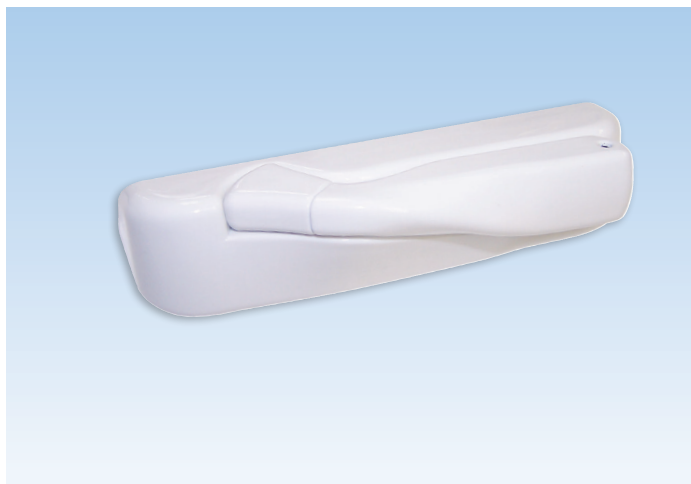

### FENIX CLASSIC Removable Cover & Fold-in Handle kit

Description	PU	Part Number
Kit type A	100	6-C2345-02-A-*
PU = Packaging Unit		

7 = White, 27 = Blue White, 6 = Black



#### Additional information

- Once the window closed, the handle folds and snaps into the cover

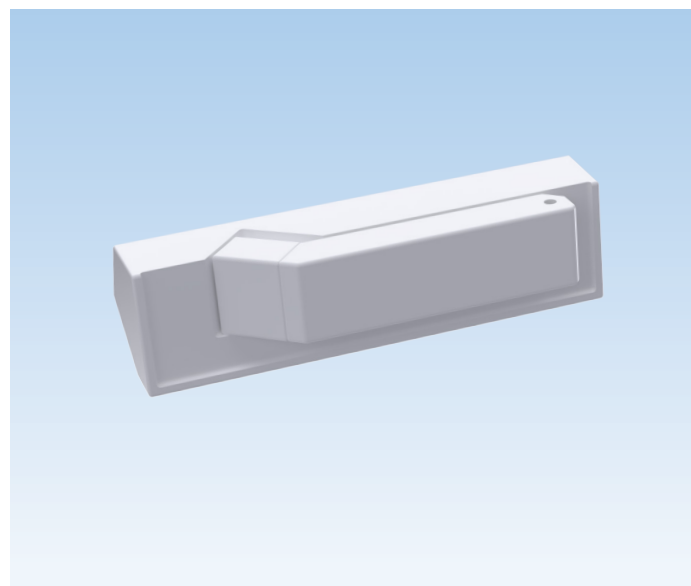

### FENIX EVO Removable Cover & Fold-in Handle kit

Description	PU	Part Number
Kit type A	10	6-C2350-00-A-*
* = Color PU = Packaging Unit		

7 = White, 27 = Blue White, 6 = Black



#### Additional information

- Once the window closed, the handle folds and snaps into the cover

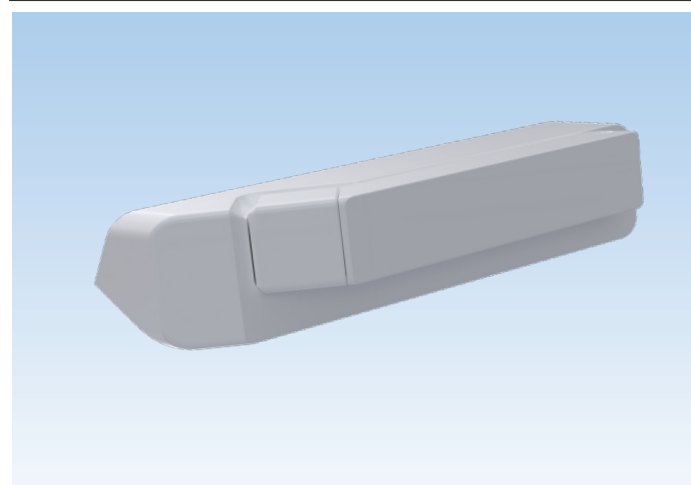

### FENIX EVO 2 Removable Cover & Fold-in Handle kit

Description	PU	Part Number
Kit type A	10	6-C2352-00-A-*
* = Color PU = Packaging Unit		

7V = Matte White, 27V = Matte Blue White, 6V = Matte Black



#### Additional information

- Once the window closed, the handle folds and snaps into the cover



### Standard Snap-on 10" & 14" Adjustable Hinges

Description	Color	PU	Part Number
<b>Casement hinge arms</b>			
Arms for 10" hinge Type A	SS	100	6-C2431-10-A-8B
Arms for 10" hinge Type B	SS	100	6-C2431-10-B-8B
Arms for 14" hinge Type A	SS	100	6-C2431-14-A-8B
Arms for 14" hinge Type B	SS	100	6-C2431-14-B-8B
<b>Casement hinge tracks</b>			
Track for 10" hinge Type A	SS	100	6-C2480-10-A-8B
Track for 10" hinge Type B	SS	100	6-C2480-10-B-8B
Track for 14" hinge Type A	SS	100	6-C2480-14-A-8B
Track for 14" hinge Type B	SS	100	6-C2480-14-B-8B
PU = Packaging Unit			

#### Additional information

- Stainless steel arms and tracks
- Solid brass adjustable pivot
- Nylon and stainless steel slide
- Stop point 90°
- Nylatron washer between arms
- Certified AAMA
- Adjustable with hexagonal 13mm (1/2") wrench
- Recommended to use SS screws 9-C9681-00-0-8 or 9-C9686-00-0-8 for installation



### Egress Snap-on 10" Adjustable Hinges

Description	Color	PU	Part Number
<b>Casement hinge arms</b>			
Egress Arms for 10" hinge Type A	SS	100	6-C2425-10-A-8B
Egress Arms for 10" hinge Type B	SS	100	6-C2425-10-B-8B
<b>Casement hinge tracks</b>			
Track for 10" hinge Type A	SS	100	6-C2480-10-A-8B
Track for 10" hinge Type B	SS	100	6-C2480-10-B-8B
PU = Packaging Unit			

#### Additional information

- Same components as the standard hinges
- Recommended to use SS screws 9-C9681-00-0-8 or 9-C9686-00-0-8 for installation



### Awning Fixed Hinges

Description	Color	PU	Part Number
<b>Awning hinges arms</b>			
Arms for 14" hinge Type A	SS	50	6-C2412-14-A-8B
Arms for 14" hinge Type B	SS	50	6-C2412-14-B-8B
Arms for 18" hinge Type A	SS	50	6-C2412-18-A-8B
Arms for 18" hinge Type B	SS	50	6-C2412-18-B-8B
Arms for 22" hinge Type A	SS	50	6-C2412-22-A-8B
Arms for 22" hinge Type B	SS	50	6-C2412-22-B-8B
Arms for 26" hinge Type A	SS	50	6-C2412-26-A-8B
Arms for 26" hinge Type B	SS	50	6-C2412-26-B-8B
<b>Awning hinges tracks</b>			
Track for 14" hinge Type A	SS	50	6-C2455-14-A-8B
Track for 14" hinge Type B	SS	50	6-C2455-14-B-8B
Track for 18" hinge Type A	SS	50	6-C2455-18-A-8B
Track for 18" hinge Type B	SS	50	6-C2455-18-B-8B
Track for 22" hinge Type A	SS	50	6-C2455-22-A-8B
Track for 22" hinge Type B	SS	50	6-C2455-22-B-8B
Track for 26" hinge Type A	SS	50	6-C2455-26-A-8B
Track for 26" hinge Type B	SS	50	6-C2455-26-B-8B

PU = Packaging Unit

### Additional information

- Stainless steel arms and tracks
- Solid brass pivot
- Stainless steel pivot clip
- Nylon and stainless steel slide
- Nylatron washer between arms
- Certified AAMA
- Recommended to use SS screws 9-C9681-00-0-8 or 9-C9686-00-0-8 for installation

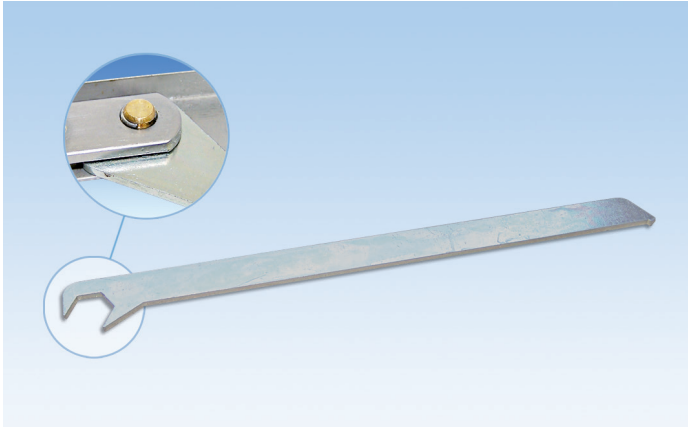

### Hexagonal Wrench

Description	Color	PU	Part Number
13mm (1/2") wrench	Zinc	1	9-C2452-20-0-1
PU = Packaging Unit			

### Additional information

- Used to adjust the adjustable hinges

# Locking Handles

For Multipoints



### FENIX CLASSIC Multipoint Locking Handle

Description	Color	PU	Part Number
Locking handle with nylon driving fork	White	100	6-C7010-35-0-7
	Blue White	100	6-C7010-35-0-27
	Black	100	6-C7010-35-0-6

PU = Packaging Unit

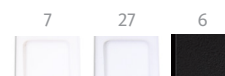

#### Additional information

- Case and handle made of "Zamak", baked enamel finish
- Reversible left hand or right hand
- 50mm locking travel – 180°
- Use with multipoint locking bars

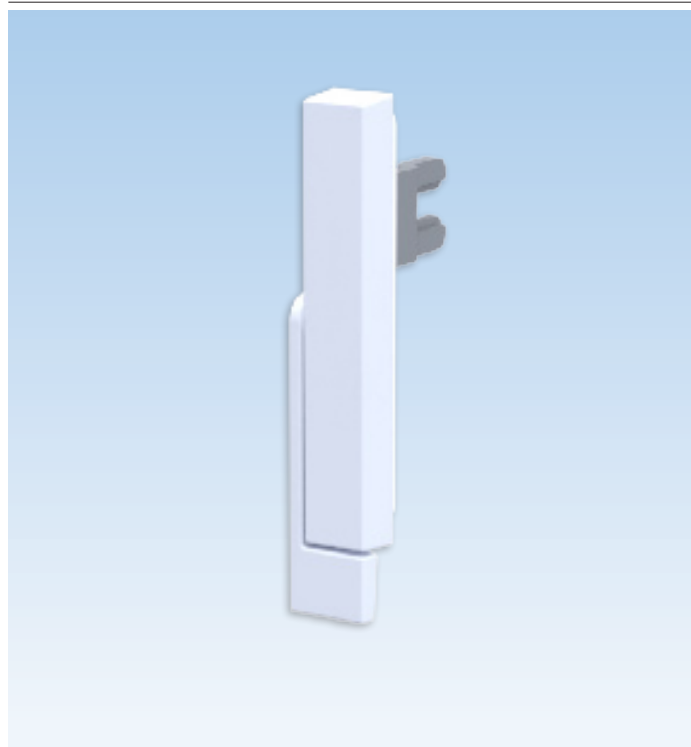

### FENIX EDGE Multipoint Locking Handle

Description	Color	PU	Part Number
Locking handle with Zamak driving fork	Matte White	100	6-C6440-35-0-7V
	Matte Blue White	100	6-C6440-35-0-27V
	Matte Black	100	6-C6440-35-0-6V

PU = Packaging Unit

7V = Matte White, 27V = Matte Blue White, 6V = Matte Black



#### Additional information

- Case and handle made of "Zamak", baked enamel finish
- Reversible left hand or right hand
- 50mm locking travel – 180°
- Use with multipoint locking bars

# Locking Handles

## For Multipoints



### FENIX EVO Multipoint Locking Handle

Description	PU	Part Number
Locking handle with zamak driving fork	20	6-C7030-00-0-*
* = Color PU = Packaging Unit		
7 = White, 27 = Blue White, 6 = Black		

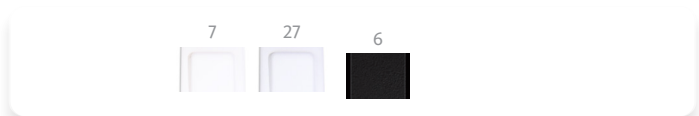

#### Additional information

- Case and handle made of "Zamak", baked enamel finish
- Reversible left hand or right hand
- 50mm locking travel – 180°
- Includes one bag of 20 spacer tabs



### FENIX CLASSIC Multipoint Locking Handle

Description	Color	PU	Part Number
Locking handle with zamak driving fork	White	100	6-C6430-35-0-7
	Blue White	100	6-C6430-35-0-27
	Black	100	6-C6430-35-0-6
PU = Packaging Unit			

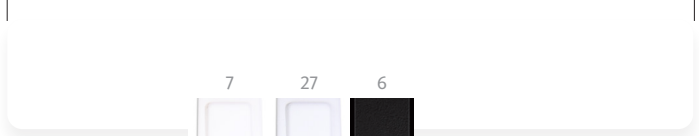

#### Additional information

- Case and handle made of "Zamak", baked enamel finish
- Reversible left hand or right hand
- 50mm locking travel – 180°
- Use with multipoint locking bars

# Locking Handles

For Singlepoint



### FENIX CLASSIC Single Point Locking Handle

Description	Color	PU	Part Number
Locking handle with steel driving fork	White	100	6-C7011-00-0-7
	Blue White	100	6-C7011-00-0-27

PU = Packaging Unit



#### Additional information

- Case and handle made of "Zamak", baked enamel finish
- Reversible left hand or right hand
- 50mm locking travel – 180°
- Locking reach of 12mm (1/2")
- Use with steel keepers 9-C2440 and 6-C2440



### FENIX CLASSIC Single Point Locking Handle

Description	Color	PU	Part Number
Locking handle with opened stop points	White	100	6-C6470-00-0-37
	Blue White	100	6-C6470-00-0-07

PU = Packaging Unit



#### Additional information

- Nylon housing, "Zamak" lever
- Baked enamel finish
- Use with steel keepers 9-C2440 and 6-C2440



### Wafer Head Screws

Description	Color	PU	Part Number
#8 x 1/2" (12mm)	Zinc	200	9-C2451-2C-0-1
PU = Packaging Unit			

### Additional information

- #8 zinc plated steel screws
- Phillips socket
- For locking handle installation

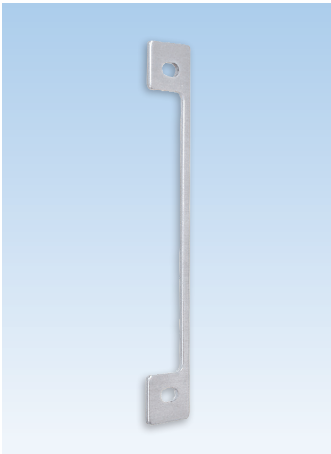

### Fixing Bracket

Description	Color	PU	Part Number
Fixing bracket for locking handles	Aluminum	1000	9-C2720-04-0-0
PU = Packaging Unit			

### Additional information

- Made of aluminum
- Use with locking handles when doing a one-step cut-out:  
 6-C6430-35-0-\*  
 6-C7010-35-0-\*  
 6-C7011-00-0-\*  
 6-C6440-35-0\*



# Multipoint Locking Bars

Series 6-C2700 for All Profiles



### Locking Bars with 8mm Cams

Dim. (mm)	Dim. (in)	Locking Cam	PU	Part Number
180	7	1	50	6-C2700-02-0-0
380	15	2	50	6-C2700-04-0-0
500	20	2	50	6-C2700-05-0-0
600	24	2	50	6-C2700-06-0-0
700	28	2	50	6-C2700-07-0-0
800	32	2	50	6-C2700-08-0-0
900	36	2	50	6-C2700-09-0-0
1000	40	3	50	6-C2700-10-0-0
1100	43	3	50	6-C2700-11-0-0
1200	47	3	50	6-C2700-12-0-0
1300	51	3	50	6-C2700-13-0-0
1400	55	3	50	6-C2700-14-0-0
1500	59	3	50	6-C2700-15-0-0
1600	63	4	50	6-C2700-16-0-0
1700	67	4	50	6-C2700-17-0-0
1800*	71	4	10	6-C2700-18-0-0
1900*	75	4	10	6-C2700-19-0-0
2000*	79	4	10	6-C2700-20-0-0

\*Only available on special request

PU = Packaging Unit

### Additional information

- Made of stainless steel
- Reinforced nylon glides
- Use with multipoint keepers (Refer to keeper section)
- Use with multipoint locking handles
- Adjustable cams ( $\pm 1$ mm) with Allen key 4mm
- Handle can be installed on first or second cam

02  
1



### Reaching Wedge

Description	Color	PU	Part Number
Half reaching wedge	Black	1	9-C0148-00-A/B-6

PU = Packaging Unit

### Additional information

- Made of nylon
- Used for multi-point locking bars
- A = used for left hand operator (outside view)  
B = used for right hand operator (outside view)
- Refer to page 4 for handling

# Multipoint Locking Bars

Series 6-C2741 For Thermoplast Profiles Only

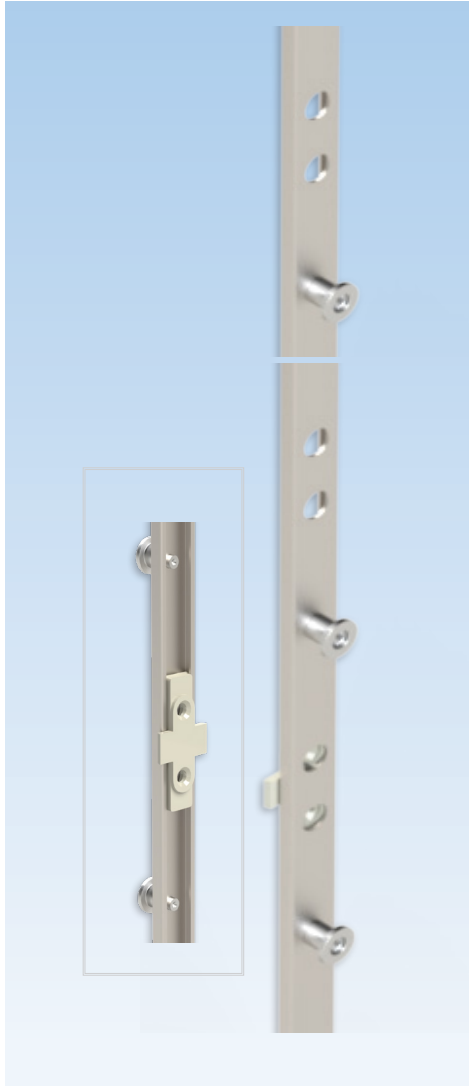

## Locking Bars with 8mm Cams

Dim. (mm)	Dim. (in)	Locking Cam	PU	Part Number
180	7	1	25	6-C2741-02-0-0
380	15	2	25	6-C2741-04-0-0
500	20	2	25	6-C2741-05-0-0
600	24	2	25	6-C2741-06-0-0
700	28	2	25	6-C2741-07-0-0
800	32	2	25	6-C2741-08-0-0
900	36	2	25	6-C2741-09-0-0
1000	40	3	25	6-C2741-10-0-0
1100	43	3	25	6-C2741-11-0-0
1200	47	3	25	6-C2741-12-0-0
1300	51	3	25	6-C2741-13-0-0
1400	55	3	25	6-C2741-14-0-0
1500	59	3	25	6-C2700-15-0-0
1600	63	4	25	6-C2741-16-0-0
1700	67	4	25	6-C2741-17-0-0
1800*	71	4	10	6-C2741-18-0-0
1900*	75	4	10	6-C2741-19-0-0
2000*	79	4	10	6-C2741-20-0-0

\*Only available on special request

PU = Packaging Unit

### Additional information

- Made of stainless steel
- Reinforced nylon glides for Thermoplast series 4600
- Use with multipoint keeper (9-C2423-T0-0-7)
- Use with multipoint locking handles
- Adjustable cams ( $\pm 1$ mm) with Allen key 4mm
- Handle can be installed on first or second cam

# Multipoint Locking Bars

Series 6-C2715 with additional locking cam



## Locking Bars with 8mm Cams

Dim. (mm)	Dim. (in)	Locking Cam	PU	Part Number
1200	47	4	50	6-C2715-12-0-0
1300	51	4	50	6-C2715-13-0-0
1400	55	4	50	6-C2715-14-0-0
1500	59	4	50	6-C2715-15-0-0
1600	63	5	50	6-C2715-16-0-0
1700*	67	5	50	6-C2715-17-0-0
1800*	71	5	10	6-C2715-18-0-0
1900*	75	5	10	6-C2715-19-0-0
2000*	79	5	10	6-C2715-20-0-0

\*Only available on special request      PU = Packaging Unit









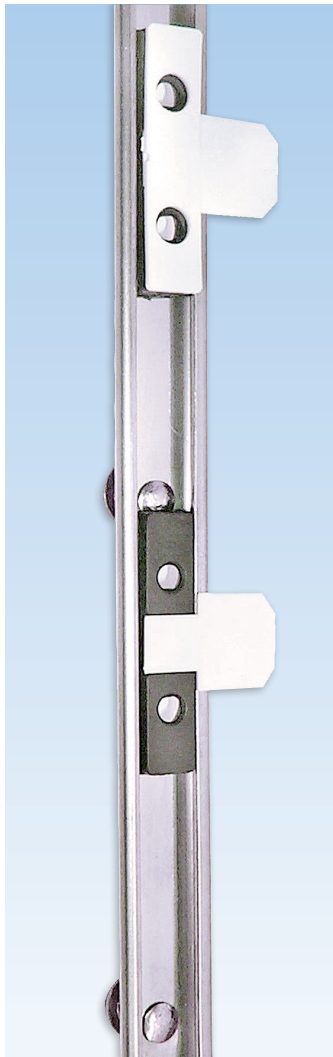
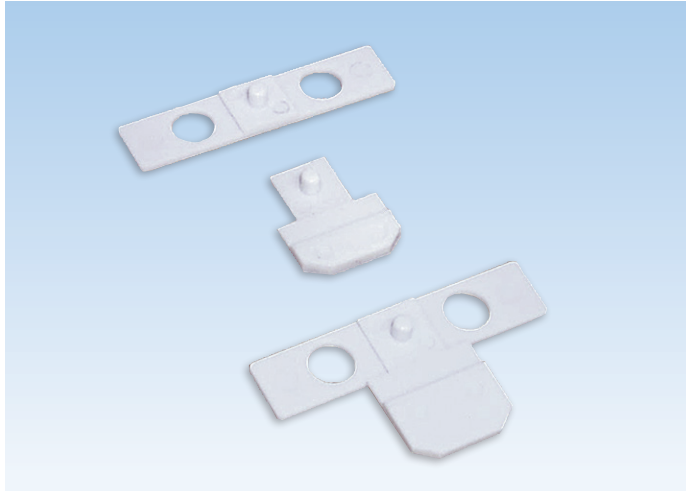



















### Additional information

- Made of stainless steel
- Reinforced nylon glides
- Use with multipoint keeper (Refer to keeper section)
- Use with multipoint locking handles
- Adjustable cams ( $\pm 1$ mm) with Allen key 4mm
- Handle can be installed on first or second cam

# Guide Shims

for Multipoint Locking Bars



		THICKNESS		
		0mm	1mm	2mm
SPACE FROM EDGE OF BAR	No Guide Shims		1 - 0  9-C2400-00-1-7	2 - 0  9-C2400-00-2-7
	Guide 6mm Shims	0 - 6  9-C2400-06-0-7	1 - 6  9-C2400-06-1-7	2 - 6  9-C2400-06-2-7
	Guide 7mm Shims	0 - 7  9-C2400-07-0-7	1 - 7  9-C2400-07-1-7	2 - 7  9-C2400-07-2-7
	Guide 8mm Shims	0 - 8  9-C2400-08-0-7	1 - 8  9-C2400-08-1-7	2 - 8  9-C2400-08-2-7
	Guide 9mm Shims	0 - 9  9-C2400-09-0-7	1 - 9  9-C2400-09-1-7	2 - 9  9-C2400-09-2-7
	Guide 10mm Shims	0 - 10  9-C2400-10-0-7	1 - 10  9-C2400-10-1-7	2 - 10  9-C2400-10-2-7
	Guide 11mm Shims	0 - 11  9-C2400-11-0-7	1 - 11  9-C2400-11-1-7	2 - 11  9-C2400-11-2-7
	Guide 12mm Shims	0 - 12  9-C2400-12-0-7	1 - 12  9-C2400-12-1-7	2 - 12  9-C2400-12-2-7
	 	 	 	

# Keepers

for Multipoint Locking Bars

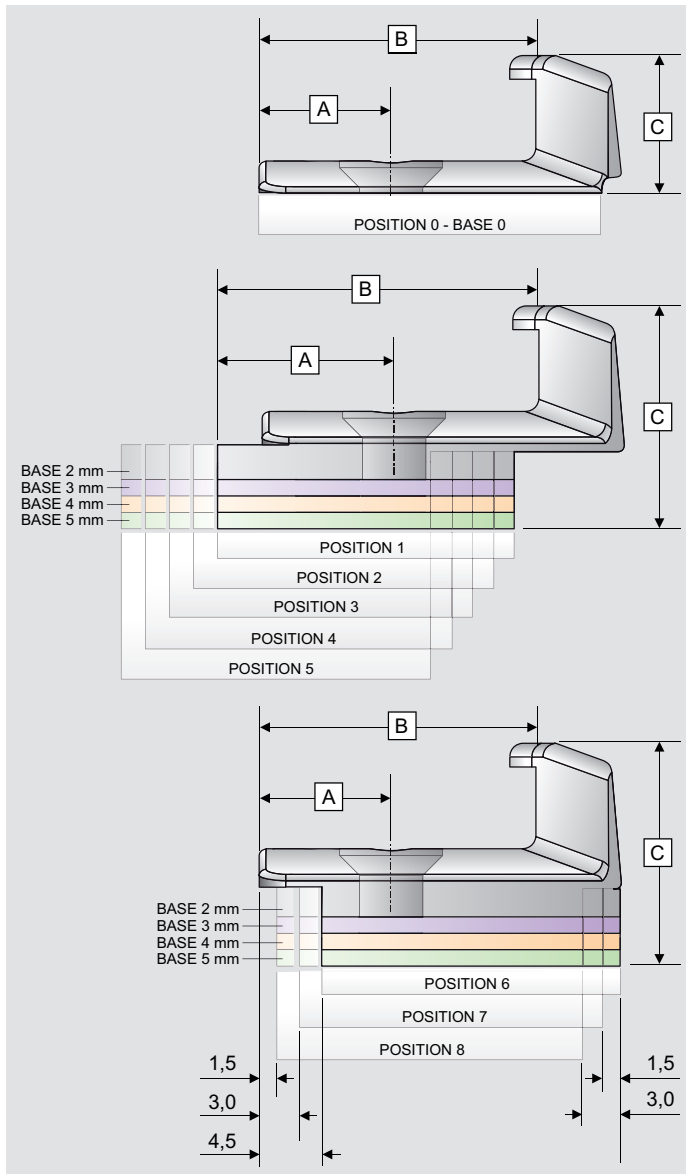
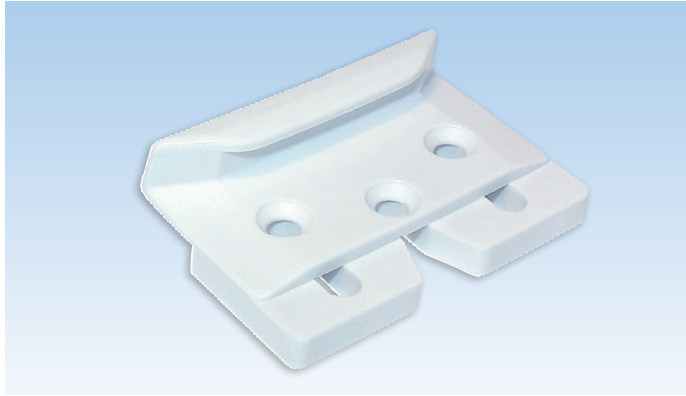

## Monobloc Keepers

Base	Pos.	Height (C) mm	Dim. (A) mm	Dim. (B) mm	PU	Part Number
0	0	11	10.0	21.0	1000	9-C2423-00-0-7
2	1	13	14.0	25.0	1000	9-C2423-21-0-7*
2	2	13	15.5	26.5	1000	9-C2423-22-0-7
2	3	13	17.0	28.0	1000	9-C2423-23-0-7
2	4	13	18.5	29.5	1000	9-C2423-24-0-7
2	5	13	20.0	31.0	1000	9-C2423-25-0-7
2	6	13	10.0	21.0	1000	9-C2423-26-0-7
2	7	13	10.0	21.0	1000	9-C2423-27-0-7
2	8	13	10.0	21.0	1000	9-C2423-28-0-7
3	1	14	14.0	25.0	1000	9-C2423-31-0-7*
3	2	14	15.5	26.5	1000	9-C2423-32-0-7
3	3	14	17.0	28.0	1000	9-C2423-33-0-7
3	4	14	18.5	29.5	1000	9-C2423-34-0-7
3	5	14	20.0	31.0	1000	9-C2423-35-0-7
3	6	14	10.0	21.0	1000	9-C2423-36-0-7
3	7	14	10.0	21.0	1000	9-C2423-37-0-7
3	8	14	10.0	21.0	1000	9-C2423-38-0-7
4	1	15	14.0	25.0	1000	9-C2423-41-0-7
4	2	15	15.5	26.5	1000	9-C2423-42-0-7*
4	3	15	17.0	28.0	1000	9-C2423-43-0-7
4	4	15	18.5	29.5	1000	9-C2423-44-0-7
4	5	15	20.0	31.0	1000	9-C2423-45-0-7
4	6	15	10.0	21.0	1000	9-C2423-46-0-7
4	7	15	10.0	21.0	1000	9-C2423-47-0-7
4	8	15	10.0	21.0	1000	9-C2423-48-0-7
5	3	16	17.0	28.0	1000	9-C2423-53-0-7

PU = Packaging Unit

## Additional information

- Monobloc keeper
- Made of nylon
- Used for multipoint locking bars
- Can suit various profile systems

\* Also available in black (-6).

Other references available on demand

# Keepers

for Multipoint Locking Bars



### Keeper

Description	Height (mm)	Color	PU	Part Number
Keeper	9.5	White	1000	9-C2311-00-0-0
PU = Packaging Unit				

### Additional information

- Made of nylon
- Used for multipoint locking bars

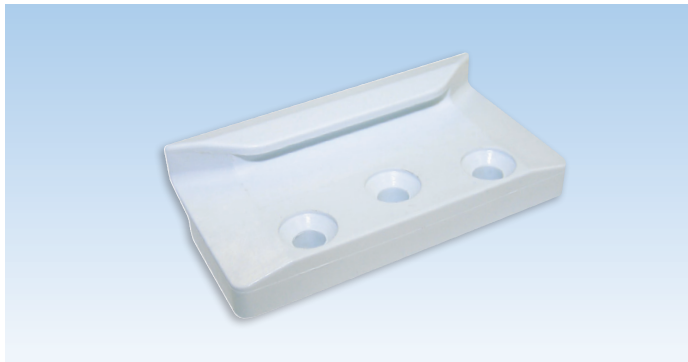

### Monobloc Keepers

Description	Height mm	Color	PU	Part Number
Keeper with base 0mm	8	White	1000	9-C2420-00-0-7 A
Keeper with base 2mm	10	White	1000	9-C2420-02-0-7 A
Keeper with base 4mm	12	White	1000	9-C2420-04-0-7 A
PU = Packaging Unit				

### Additional information

- Monobloc keeper
- Made of nylon
- Used for multipoint locking bars
- Can suit various profile systems

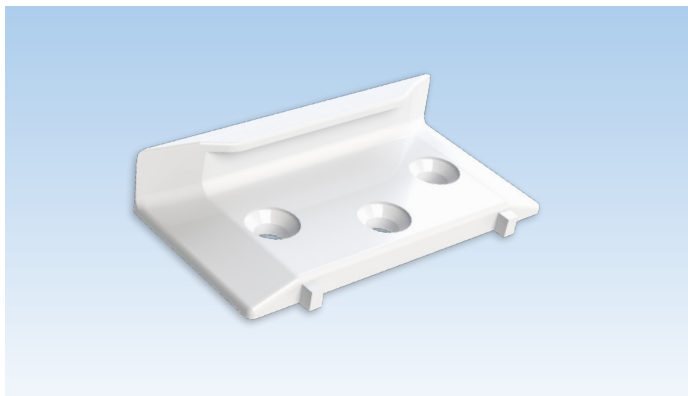

### Monobloc Keepers for Thermoplast profiles

Base	Pos.	Height (C) mm	Dim. (A) mm	Dim. (B) mm	PU	Part Number
0	0	13	14.0	25.5	1000	9-C2423-T0-0-*
*=Colors					PU = Packaging Unit	
7 = White, 6 = Black						

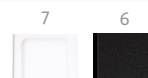

### Additional information

- Monobloc keeper for Thermoplast series 4600
- Made of nylon
- Used for multipoint locking bars (6-C2741-XX-0-0)

# Single Point Keepers



## Single Point Keepers

Description	Height mm	PU	Part Number
Keeper	2	100	9-C2440-02-0-8
Keeper	3.5	100	9-C2440-03-0-1
Keeper with nylon shim	5	100	6-C2440-05-0-1
Keeper with nylon shim	6.5	100	6-C2440-06-0-1
Keeper	8	100	9-C2440-08-0-1
Keeper with nylon shim	9.5	100	6-C2440-09-0-1
Keeper with nylon shim	11	100	6-C2440-11-0-1

PU = Packaging Unit

### Additional information

- Made of steel plated FerGUard
- Vertical adjustment 12mm
- Anti-slip fixing hole
- Use with locking handles 6-C7011-00-0-\* and 6-C6470-00-0-\*

02  
1

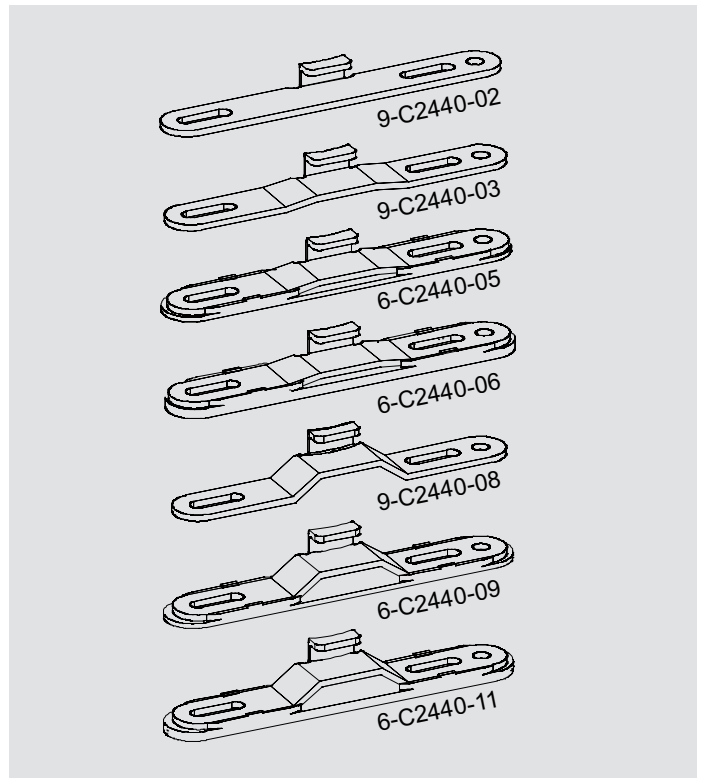

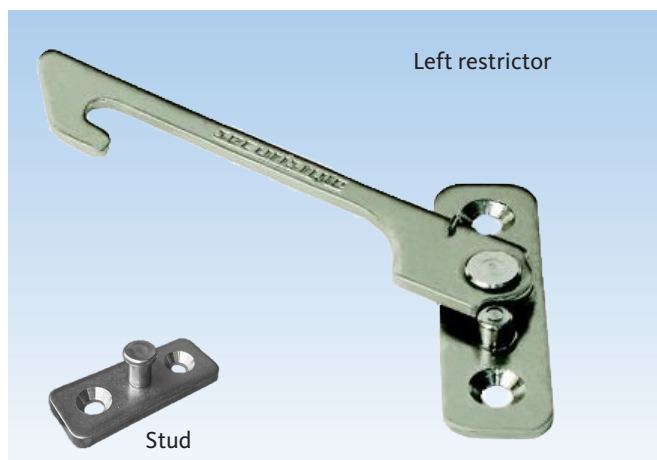

### Restrictors

Description	Color	PU	Part Number
66mm opening gap restrictor	SS	25	6-C8659-00-L/R-8B
116mm opening gap restrictor	SS	25	6-C8660-00-L/R-8B
Stud 13mm / 16mm	SS	25	6-C8658-XX-0-8B

PU = Packaging Unit

### Additional information

- Made of 304 Stainless steel
- Easy to fit with no routing
- Compatible with standard duty hinges
- Enhanced corrosion resistance
- Must purchase one restrictor and one stud separately
- Recommended to use of SS screws 9-C9681-00-0-8 or 9-C9686-00-0-8 for installation





### Adjustable Snubber

Description	Color	PU	Part Number
Set of snubber	Zinc	500	6-C9207-00-0-1
PU = Packaging Unit			

#### Additional information

- Made of steel
- Installs in the hinge cavity
- Used with E-12562 flat head screws
- Adjustable for compression
- Recommended to use of SS screws 9-C9681-00-0-8 or 9-C9686-00-0-8 for installation

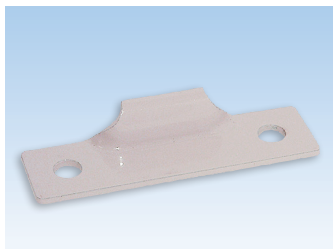

### Snubber

Description	Color	PU	Part Number
Snubber	Tan	500	9-C9202-09-0-2
	SS	500	9-C9202-09-0-8
PU = Packaging Unit			

#### Additional information

- Made of painted steel or stainless steel
- Installs in the hinge cavity
- Used with E-12562 flat head screws
- 2 pieces are required for the assembly



### Snubber (exterior)

Description	Color	PU	Part Number
Snubber	White	500	9-C2723-00-0-7
PU = Packaging Unit			

#### Additional information

- Made of painted steel
- Installs from exterior or in the hinge cavity
- Used with E-12562 flat head screws
- 2 pieces are required for the assembly (option 2)

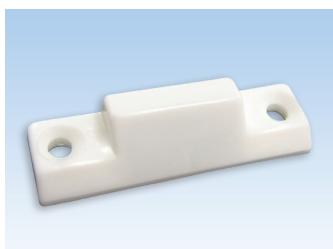

### Wedge

Description	Color	PU	Part Number
10mm run-up block	White	100	9-C3279-10-0-7
PU = Packaging Unit			

#### Additional information

- Made of nylon



#### Screws for Hardware Fixing

Description	Dimension mm	Color	PU	Part Number
D1 screws	4.2 x 13	Zinc	1000	E-12562-13-0-1
D1 screws	4.2 x 16	Zinc	1000	E-12562-16-0-1
D1 screws	4.2 x 20	Zinc	1000	E-12562-20-0-1
D1 screws	4.2 x 22	Zinc	1000	E-12562-22-0-1
D1 screws	4.2 x 25	Zinc	1000	E-12562-25-0-1
D1 screws	4.2 x 30	Zinc	1000	E-12562-30-0-1
D1 screws	4.2 x 35	Zinc	1000	E-12562-35-0-1
D1 screws	4.2 x 40	Zinc	1000	E-12562-40-0-1

PU = Packaging Unit

#### Additional information

- Type D1 with self-drilling spiral point and high duplex thread
- Used for fastening fittings into semi-hard PVC at high speed
- Phillips socket



#### “No Corrode” Screws for Hardware Fixing

Description	Dimension mm	Color	PU	Part Number
D1 screws	4.2 x 13	Zinc	5000	9-C9911-5M-0-1
D1 screws	4.2 x 16	Zinc	5000	9-C9912-5M-0-1
D1 screws	4.2 x 20	Zinc	5000	9-C9914-5M-0-1
D1 screws	4.2 x 25	Zinc	5000	9-C9916-5M-0-1

\* = Color      PU = Packaging Unit

#### Additional information

- Type D1 with self-drilling spiral point and high duplex thread
- Used for fastening fittings into semi-hard PVC at high speed
- Robertsons socket



SS Screws			
Description	Color	PU	Part Number
#10 x 5/8" (16mm)	SS	10 000	9-C9681-00-0-8
#10 x 1/2" (13mm)	SS	10 000	9-C9686-00-0-8
PU = Packaging Unit			

**Additional information**

- Stainless steel screws
- Undercut #7 head with “Quadrex” socket
- Sharp tip for quick drive
- Slim head for more clearance
- Special thread design for thin wall profile
- For dual track, awning track, hinge arm, hinge track, surface bracket, 90° bracket, restrictor and adjustable snubber installation

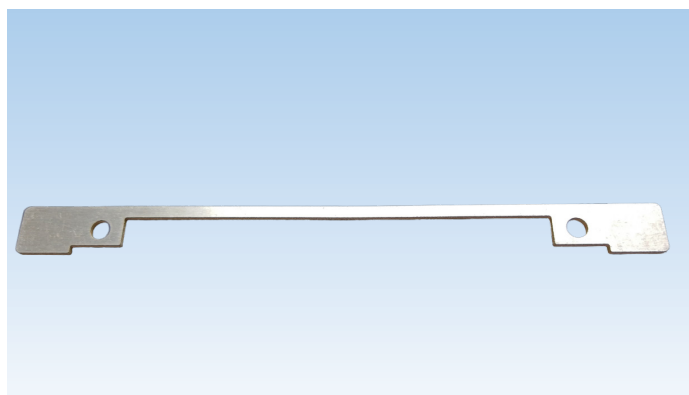

Fixing bracket			
Description	Color	PU	Part Number
Fixing bracket for Operator	Aluminum	1	9-C2341-00-0-1
PU = Packaging Unit			

**Additional information**

- Made of aluminum
- Used to increase the Operator stability
- Use with Operator for casement and awning windows:  
Dyad operator 6-C2332-\*\*-L/R-8  
Dual Arm operator 6-C2331-\*\*-L/R-8  
Scissor Arm 6-C2340-00-0-8
- Use self-tapping No 8 - 5/8" screws, non-countersunk

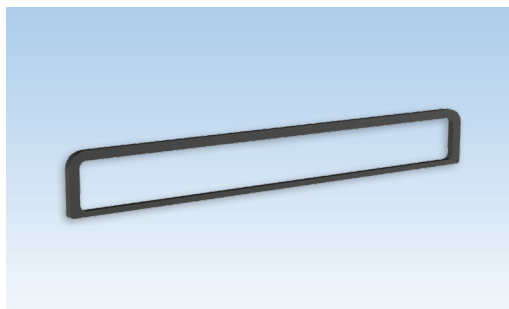

### Adhesive gasket

Description	Color	PU	Part Number
Operator Replacement Gasket	Black	1	9-C0964-01-0-6
Operator Replacement Gasket	White	1	9-C0964-01-0-7

PU = Packaging Unit

### Additional information

- Made of EVA foam



### Spacer tab

Description	Color	PU	Part Number
Spacer tab	Black	1	9-C0958-00-0-0

PU = Packaging Unit

### Additional information

- Made of ABS
- Use with locking handle FENIX EVO 6-C7030-00-0-\*

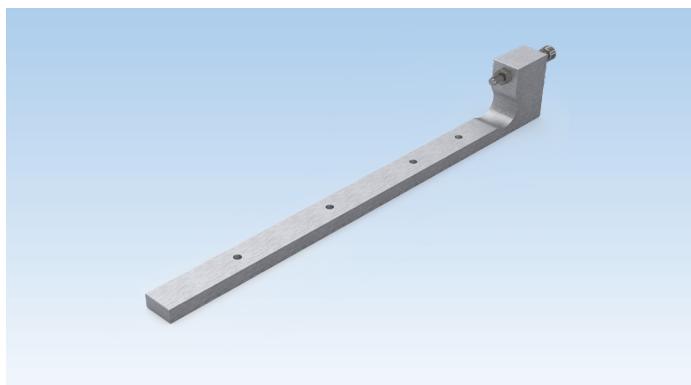

### Casement Hinges Jig

Description	PU	Part Number
Casement hinges jig	1	6-C9250-00-0-1

PU = Packaging Unit

### Additional information

- Use for casement hinge arms pilot holes on sash
- Includes adjustment screw and nut
- Made of Aluminum

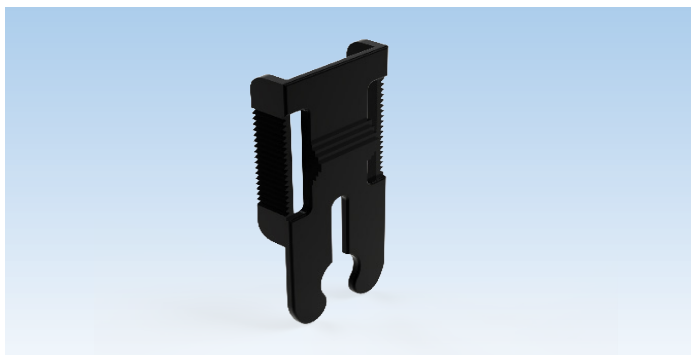

### Replacement Clip

Description	PU	Part Number
Replacement Clip	1	9-C2339-00-0-6

PU = Packaging Unit

### Additional information

- Clip for Scissor arm operator

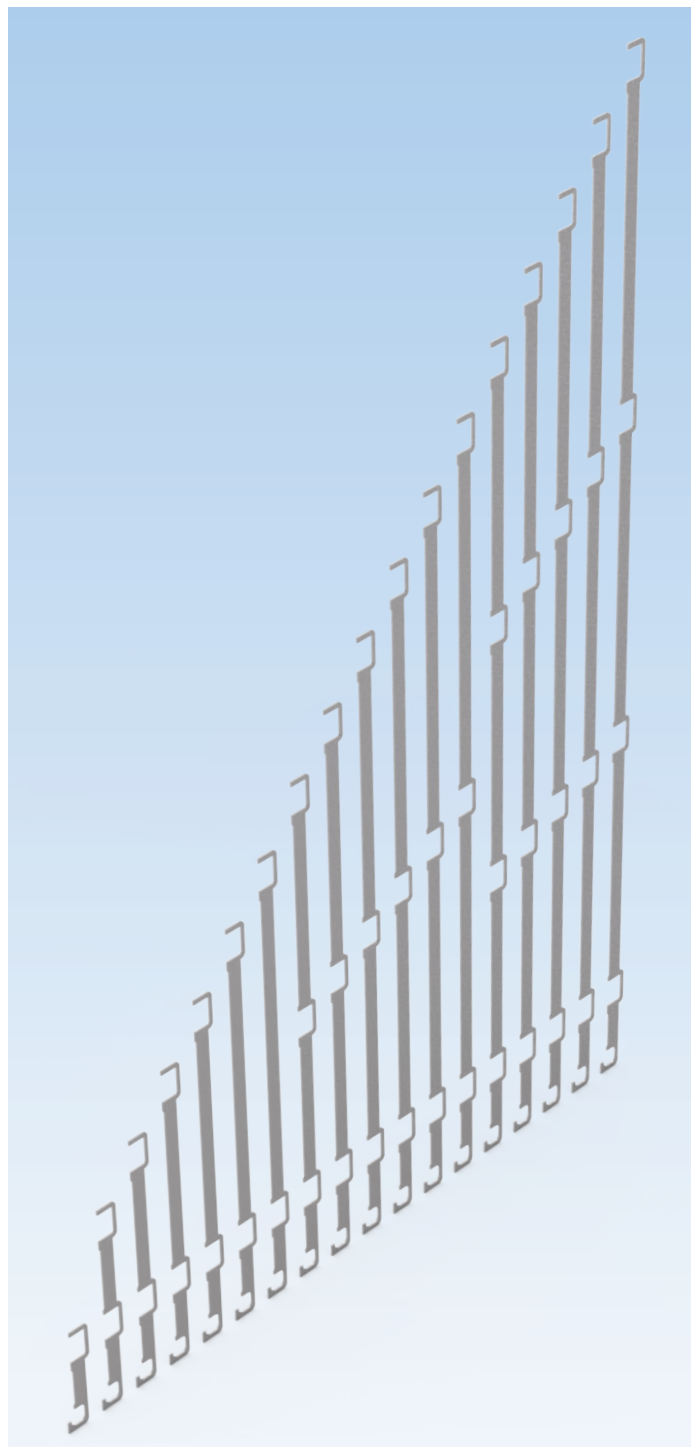

### Keepers Jig

Description	PU	Part Number
Keepers jig kit	1	K-C9252-22-0-1
PU = Packaging Unit		

### Additional information

- Use with multipoint locking bars and keepers
- Sold as a kit (for 180mm-2000mm locking bars)
- Made of galvanized steel
- Jig kits are prepared for a specific profile and components
- When ordering, please add a note with the profile model and list of references

**Fenix samples kit**

Description	PU	Part Number
Fenix samples kit	1	K-C0230-00-0-0
PU = Packaging Unit		
Additional information		
Kit breakdown	Qty	Part Number
Dual Arm Operator	1	6-C2331-00-L-8
Dual Arm Operator short arm	1	6-C2331-MC-L-8
Track for Dual Arm Operator	1	6-C2336-00-0-8
Dyad Operator	1	6-C2332-00-R-8
Dyad Operator short arm	1	6-C2332-MC-R-8
Scissor Arm Operator	1	6-C2340-00-0-8
Track for Scissor Arm Operator	1	6-C2335-01-0-8
90° Bracket	1	6-C2320-00-0-8
Surface mounted Bracket	1	6-C2307-00-L-8
FENIX CLASSIC Removable Cover & Fold-in Handle kit	1	6-C2345-02-A-27
FENIX CLASSIC Removable Cover & Fold-in Handle kit	1	6-C2345-02-B-7
FENIX EVO2 Removable Cover & Fold-in Handle kit	1	6-C2352-00-A-27
FENIX EVO2 Removable Cover & Fold-in Handle kit	1	6-C2352-00-B-7
FENIX EVO2 Removable Cover & Fold-in Handle kit	1	6-C2352-00-A-6V
Casement hinge arm 10"	1	6-C2431-10-A-8B
Casement hinge arm 10"	1	6-C2431-10-B-8B
Track for 10" hinge	1	6-C2480-10-A-8B
Track for 10" hinge	1	6-C2480-10-B-8B
Fenix Classic Locking handle with nylon driving fork	1	6-C7010-35-0-27
Fenix Classic Locking handle with nylon driving fork	1	6-C7010-35-0-7
Fenix Classic Locking handle with zamak driving fork	1	6-C7030-00-0-27
Fenix Classic Locking handle with zamak driving fork	1	6-C7030-00-0-7
Fenix Edge Locking handle with Zamac driving fork	1	6-C6440-35-0-7V
Fenix Edge Locking handle with Zamac driving fork	1	6-C6440-35-0-27V
Fenix Edge Locking handle with Zamac driving fork	1	6-C6440-35-0-6V
Locking Bars with 8mm Cams	1	6-C2700-04-0-0
Reaching Wedge	1	9-C0148-00-A-6
Monobloc Keeper - White	1	9-C2423-T0-0-7
Monobloc Keeper - Black	1	9-C2423-T0-0-6
Adjustable Snubber	1	6-C9207-00-0-1
Fixing bracket for locking handles	1	9-C2720-04-0-0
Fixing bracket for operator	1	9-C2341-00-0-1
Qty = Quantity		



WINDOW TECHNOLOGY  
DOOR TECHNOLOGY  
AUTOMATIC ENTRANCE SYSTEMS  
BUILDING MANAGEMENT SYSTEMS

HEAD OFFICE  
Ferco Architectural Hardware Inc.  
2000, Berlier St.  
Laval, QC H7L 4S4  
Tel.: 450 973-1437  
1 800 355-8810  
Fax: 450 973-7661  
ferco@ferco.ca

ONTARIO / WESTERN PROVINCES  
Tel.: 905 282-9588  
1 800 668-5310  
Fax: 905 282-9915

UNITED STATES  
Tel.: 1 800 927-1097  
Fax: 1 888 454-0161

[www.ferco.ca](http://www.ferco.ca)

Edition 05.2022 | Printed in Canada

02  
1

Securing technology for you

