



WINDOW TECHNOLOGY
DOOR TECHNOLOGY
AUTOMATIC ENTRANCE SYSTEMS
BUILDING MANAGEMENT SYSTEMS



DOOR TECHNOLOGY – ORDER CATALOG | SECTION 03.2



SECURY Automatic Door Lock & Lever Handle

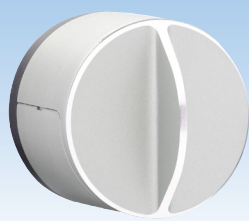

Securing technology for you





03.2

SECURY Automatic Door Lock & Lever Handle

GEARS

| | |
|---|--------|
| SECURY Automatic Door Lock | 03.2.5 |
| Automatic Extension | 03.2.6 |
| Filler Pieces | 03.2.7 |
| Mortise Door Lock | 03.2.8 |

HANDLES

| | |
|---------------------------------------|---------|
| Introduction | 03.2.9 |
| Finishes for handle set program | 03.2.10 |

30mm Plate Series

| | |
|-------------------------|---------|
| ALLEGRO Trim Kits | 03.2.12 |
| TORINO Trim Kits | 03.2.13 |
| VENICE Trim Kits | 03.2.14 |

45mm Plate Series

| | |
|------------------------|---------|
| CAPRI Trim Kits | 03.2.15 |
| TORINO Trim Kits | 03.2.16 |
| VENICE Trim Kits | 03.2.17 |

55mm Plate Series

| | |
|----------------------|---------|
| ROMA Trim Kits | 03.2.18 |
|----------------------|---------|

65mm Plate Series & BELCANTO Handle

| | |
|------------------------------------|---------|
| BERLIN Trim Kits | 03.2.19 |
| BERLIN Trim Kits | 03.2.20 |
| Belcanto Handle & US Rosette | 03.2.21 |

ACCESSORIES

| | |
|---------------------|---------|
| Smart locks | 03.2.22 |
| Strike Plates | 03.2.28 |
| Accessories | 03.2.31 |

| | |
|---------------------------|---------|
| Wood Mount Displays | 03.2.40 |
|---------------------------|---------|

SECURY Automatic Door Lock

for lever handle with North American Cylinder



Unlocked



Locked

USE WITH LEVER HANDLES ONLY

SECURY Automatic Door Lock for Lever Handle

| Description | Backset | Color | PU | Part Number |
|---------------------------|---------|-------|----|-----------------|
| Door lock for 6' 8" doors | 45mm | SS | 5 | 6-35856-01-R-8B |
| Door lock for 8' doors | 45mm | SS | 5 | 6-35856-02-R-8B |
| Door lock for 6' 8" doors | 50mm | SS | 5 | 6-36033-01-R-8B |
| Door lock for 8' doors | 50mm | SS | 5 | 6-36033-02-R-8B |
| Door lock for 6' 8" doors | 60mm | SS | 5 | 6-35565-01-R-8B |
| Door lock for 8' doors | 60mm | SS | 5 | 6-35565-02-R-8B |

PU = Packaging Unit

Simply Close the Door!

As soon as the door pulled shut, the Automatic latchbolts instantly throw 20mm and are secured to prevent them being forced back. By turning the key or the knob, the center deadbolt will engage and lock the top and bottom latchbolts to become a **3-deadbolt locking system**.

Additional information

- 3-point, one piece locking system for 6' 8" and 8' doors
- Heavy duty mortise construction with reinforced lever return spring system
- Locking by US-cylinder with 90° turn of key or thumb-turn
- No lifting of handle to engage locking points
- Top and bottom Automatic latchbolt projection from 10 to 20mm:
 - Provides security
 - Protects the door
- 1" (25mm) throw on deadbolt with baby sitting function
- Non handed, latch easily reversible
- 8mm square spindle
- 92mm centres (spindle to cylinder)
- Handle height variable (36" recommended)
- 16mm stainless steel faceplate with radius ends for easy installation and cleaner look
- Same hardware groove detail throughout our entire door lock program (jig, router base and bits available)
- Various extension with additional lock point is available for doors taller than 8'
- To be used with lever handle set (US-cylinder above handle)

Automatic Extension

with Additional Latchbolt

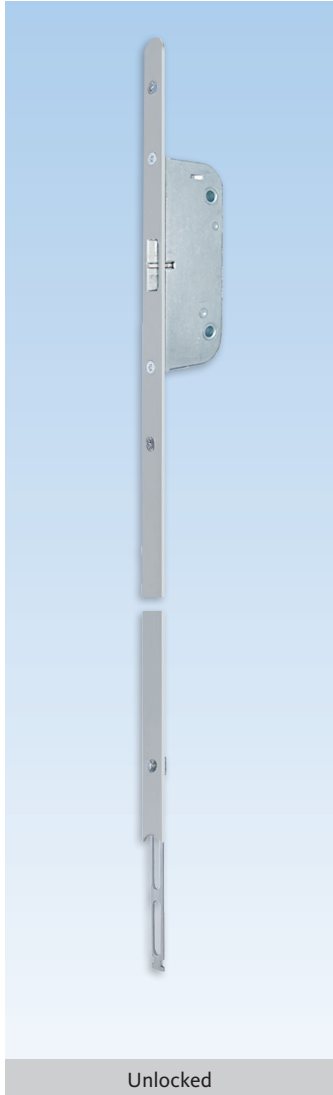

Unlocked

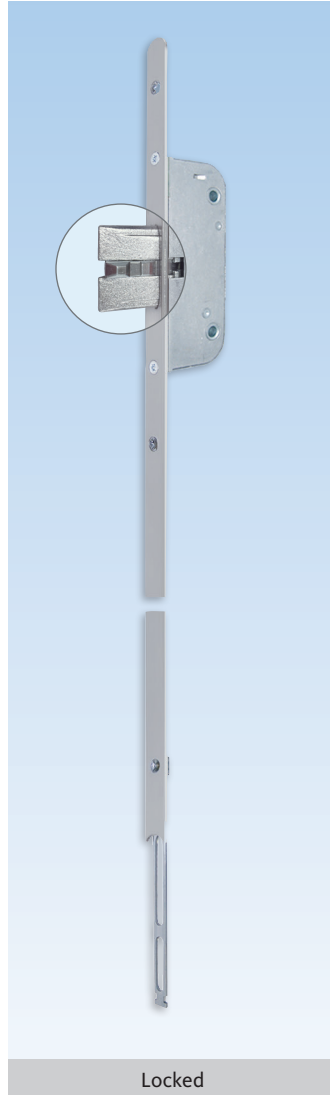

Locked

Extension with Additional Latchbolt

| Description | Color | PU | Part Number |
|-----------------------------------|-----------------|---------------------|-----------------|
| 525mm extension with rounded end | Stainless Steel | 5 | 6-33479-04-0-8B |
| 800mm extension with rounded end | Stainless Steel | 1 | 6-C5078-00-0-8B |
| 1050mm extension with rounded end | Stainless Steel | 1 | 6-C5062-10-0-8B |
| 1325mm extension with rounded end | Stainless Steel | 1 | 6-C5062-13-0-8B |
| * = Color | | PU = Packaging Unit | |

Additional information

- Tapered latch always engaging in strike plate
- 16mm stainless steel faceplate with radius end for easy installation and cleaner look
- Additional locking point for doors taller than 8'
- To be used with GU-SECURY Automatic door Locks

Filler pieces

Round to square

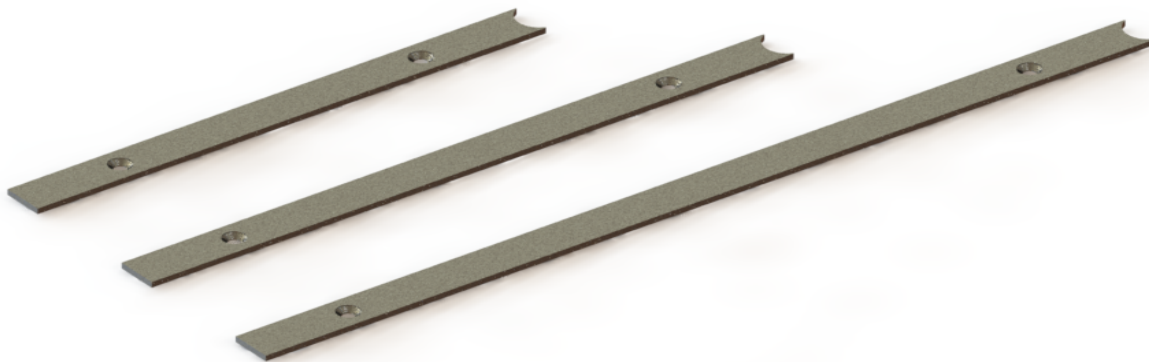

Filler Pieces

| Description | PU | Part Number |
|----------------------|----|-----------------|
| Filler piece 193,7mm | 1 | 9-C4340-19-0-8B |
| Filler piece 245,9mm | 1 | 9-C4342-24-0-8B |
| Filler piece 342,3mm | 1 | 9-C4342-34-0-8B |

Additional information

- Made of stainless steel
- To be used with radius end locks and extensions

Formulas to select filler length:

- Bottom:
L = Handle height - 671,7mm
- Top 1590mm lock:
L = Door height - handle height - extension(s) length - 920,7mm
- Top 1900mm lock:
L = Door height - handle height - extension(s) length - 1230,7mm

Mortise Door Lock

with Latch and Deadbolt



Unlocked



Locked

Mortise Door Lock for Lever Handle

| Description | Color | PU | Part Number |
|-----------------------------|-----------------|----|----------------|
| Door lock with 45mm backset | Stainless Steel | 10 | 6-C4893-45-0-8 |
| Door lock with 50mm backset | Stainless Steel | 10 | 6-C4893-50-0-8 |
| Door lock with 60mm backset | Stainless Steel | 10 | 6-C4893-60-0-8 |

* = Color PU = Packaging Unit

Additional information

- Heavy duty mortise construction with reinforced lever return spring system
- Locking by US-cylinder with 90° turn of key or thumb-turn to engage the 1" (25mm) deadbolt
- Non-handed, latch easily reversible
- 8mm square spindle
- 92mm centres (spindle to cylinder)
- 16mm stainless steel faceplate with radius ends for easy installation and cleaner look
- Same hardware groove detail throughout our entire door lock program (jig, router base and bits available)
- Ideal for exterior and interior door applications
- To be used with lever handle set (US-cylinder above handle)



Ferco lever handle sets are uniquely designed to operate on multipoint door locks. Our handle sets withstand the rigorous everyday operational wear & tear of engaging or disengaging multiple lock points. **Our handle sets are designed for long term use!**

- **Patented handle snap-rings** allow for handles to be shipped non-handed. The manufacturer no longer has to worry about ordering left or right, and will save on inventory.
- **Handle setscrews to fasten spindles** combined with the snap-ring will ensure the handle will stay tight on the door for a long time.
- **Self centering 8mm split Spindle** to make sure it is always centered into the door.
- **Longer Screw ports on escutcheons:** Ferco has added an interior sleeve port that will guide the M5 mm screw straight to the opposing exterior screw port.
- **Exterior O-ring on handle shaft** to prevent water from entering around the exterior handle.
- **Washers between handle and escutcheon** making sure the handle operation is and remains smooth.
- **Escutcheon Foam gasket** to prevent air and cold.
- **Rubber gasket** (Order separately) to prevent air and water leakage around the exterior escutcheon.
- **Schlage Cylinder with one tail for both 1 ¾” and 2 ¼” thick doors**
- **M5 handle set screws to fasten the escutcheons** included in every handle set kit.
- **Handle above cylinder or handle below cylinder option**
- **FERCO handle sets available** in Solid Brass or economical zinc die-cast material with selections in many plate designs, lever styles and finishes.

Finishes For Handle Set Program

- US-Cylinder Above Handle



| | SOLID BRASS | | | | | | ZAMAC | | | | | |
|-------------------|--|---|---|--|---|---|--|---|---|--|---|---|
| | 45mm PLATE | | | 30mm PLATE | | | 45mm PLATE | | | 30mm PLATE | | |
| | | | | | | | | | | | | |
| | CAPRI K-U6292-01 K-U6246-00 K-U6210-00 | TORINO K-U6492-01 K-U6446-00 K-U6410-00 | VENICE K-U6692-01 K-U6646-00 K-U6610-00 | ALLEGRO K-U3192-01 K-U3146-00 K-U3110-00 | TORINO K-U3492-01 K-U3446-00 K-U3410-00 | VENICE K-U3692-01 K-U3646-00 K-U3610-00 | CAPRI K-U7292-Z1 K-U7246-Z0 K-U7210-Z0 | TORINO K-U7492-Z1 K-U7446-Z0 K-U7410-Z0 | VENICE K-U7692-Z1 K-U7646-Z0 K-U7610-Z0 | ALLEGRO K-U5192-Z1 K-U5146-Z0 K-U5110-Z0 | TORINO K-U5492-Z1 K-U5446-Z0 K-U5410-Z0 | VENICE K-U5692-Z1 K-U5646-Z0 K-U5610-Z0 |
| Satin Chrome | 01 | 01 | 01 | 01 | 01 | 01 | | 01 | 01 | 01 | 01 | 01 |
| Polished Brass | 03 | 03 | 03 | 03 | 03 | 03 | | | | | | |
| Antique Brass | 04 | 04 | 04 | 04 | 04 | 04 | | | | | | |
| Oil Rubbed Bronze | 05 | 05 | 05 | 05 | 05 | 05 | | | | | | |
| Dark Bronze PC | | | | | | | 5 | 5 | 5 | 5 | 5 | 5 |
| Black PC | | | | | | | 6 | 6 | 6 | 6 | 6 | 6 |
| White PC | | | | | | | 7 | 7 | 7 | 7 | 7 | 7 |
| Satin Nickel | 11 | 11 | 11 | 11 | 11 | 11 | | | | | | |
| Dark Bronze | 25 | 25 | 25 | 25 | 25 | 25 | | | | | | |
| Pewter | 28 | 28 | 28 | 28 | 28 | 28 | | 28 | 28 | 28 | 28 | 28 |







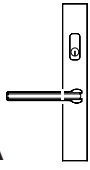
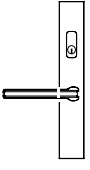
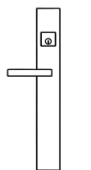
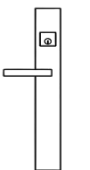

Colors on this document are graphic representation and may not be an exact match for the actual painted/plated hardware.
For color selection, material samples are available on request.

* information in this document can be modified without notice. Finishes Handle Sets Program_03-2021

Finishes For Handle Set Program

- US-Cylinder Above Handle



| | SOLID BRASS 55mm PLATE | ZAMAC 55mm PLATE | SOLID BRASS 65mm PLATE | ZAMAC 65mm PLATE |
|-------------------|--|--|---|--|
| |  ROMA K-U4092-01 K-U4046-00 K-U4010-00 |  ROMA K-U9092-Z1 K-U9046-Z0 K-U9010-Z0 |  BERLIN K-U2592-Z1 K-U2546-Z0 K-U2510-Z0 |  BERLIN K-U8592-Z1 K-U8546-Z0 K-U8510-Z0 |
| Satin Chrome | | | | |
| Polished Brass | | | | |
| Antique Brass | | | | |
| Oil Rubbed Bronze | | | | |
| Dark Bronze PC | | | | 5  |
| Black PC | | 6  | | 6  |
| White PC | | | | |
| Satin Nickel | 11  | | 11  | |
| Dark Bronze | 25  | | | |
| Pewter | 28  | | 28  | |

Colors on this document are graphic representation and may not be an exact match for the actual painted/plated hardware. For color selection, material samples are available on request.

ALLEGRO Handles & 30mm Plates



ALLEGRO Solid brass Trim Kits

| Description | PU | Part Number |
|---|----|----------------|
| Handle sets for active doors with US-cylinder | 1 | K-U3192-01-0-* |
| Handle sets for semi-active doors | 1 | K-U3146-00-0-* |
| Handle sets for fixed doors | 1 | K-U3110-00-0-* |

* = Color PU = Packaging Unit

01 = Satin Chrome, 03 = Polished Brass, 04 = Antique Brass, 05 = Oil Rubbed Bronze, 11 = Satin Nickel, 25 = Dark Bronze, 28 = Pewter

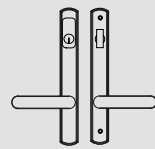
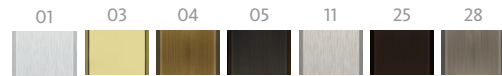

K-U3192-01-0-*

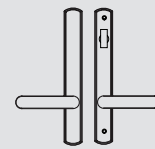

K-U3146-00-0-*

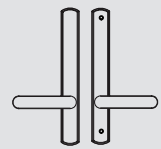

K-U3110-00-0-*

Additional information

- Unassembled solid brass trim kits
- US-cylinder with standard 5 pins Schlage "C" keyway
- 90° locking with thumb-turn
- Self-centering 8mm spindle

- Stainless steel set screw on levers to secure spindle
- Patented handle clipping system
- Kit for 1 3/4" and 2 1/4" thick doors
- US-cylinder above handle



ALLEGRO Zamac Trim Kits

| Description | PU | Part Number |
|---|----|----------------|
| Handle sets for active doors with US-cylinder | 1 | K-U5192-Z1-0-* |
| Handle sets for semi-active doors | 1 | K-U5146-Z0-0-* |
| Handle sets for fixed doors | 1 | K-U5110-Z0-0-* |

* = Color PU = Packaging Unit

01 = Satin Chrome, 5 = Dark Bronze PC, 6 = Black PC, 7 = White PC, 28 = Pewter

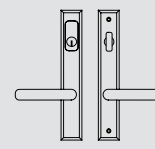
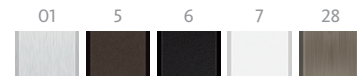

K-U5192-Z1-0-*

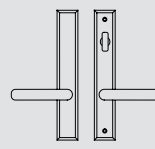

K-U5146-Z0-0-*

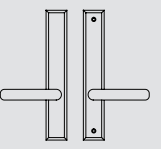

K-U5110-Z0-0-*

Additional information

- Unassembled zamac trim kits
- US-cylinder with standard 5 pins Schlage "C" keyway
- 90° locking with thumb-turn
- Self-centering 8mm spindle

- Stainless steel set screw on levers to secure spindle
- Patented handle clipping system
- Kit for 1 3/4" and 2 1/4" thick doors
- US-cylinder above handle

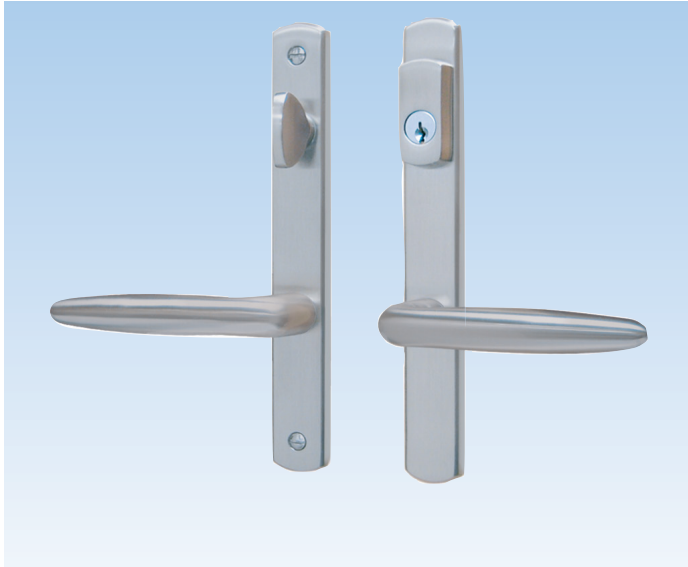

TORINO Solid brass Trim Kits

| Description | PU | Part Number |
|---|----|----------------|
| Handle sets for active doors with US-cylinder | 1 | K-U3492-01-0.* |
| Handle sets for semi-active doors | 1 | K-U3446-00-0.* |
| Handle sets for fixed doors | 1 | K-U3410-00-0.* |

* = Color PU = Packaging Unit

01 = Satin Chrome, 03 = Polished Brass, 04 = Antique Brass,
05 = Oil Rubbed Bronze, 11 = Satin Nickel, 25 = Dark Bronze, 28 = Pewter

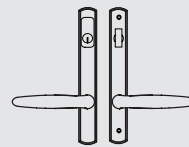
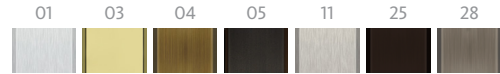

K-U3492-01-0.*

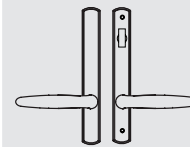

K-U3446-00-0.*

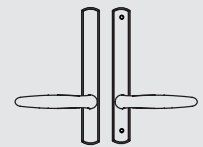

K-U3410-00-0.*

Additional information

- Unassembled solid brass trim kits
- US-cylinder with standard 5 pins Schlage "C" keyway
- 90° locking with thumb-turn
- Self-centering 8mm spindle

- Stainless steel set screw on levers to secure spindle
- Patented handle clipping system
- Kit for 1 3/4" and 2 1/4" thick doors
- US-cylinder above handle



TORINO Zamac Trim Kits

| Description | PU | Part Number |
|---|----|----------------|
| Handle sets for active doors with US-cylinder | 1 | K-U5492-Z1-0.* |
| Handle sets for semi-active doors | 1 | K-U5446-Z0-0.* |
| Handle sets for fixed doors | 1 | K-U5410-Z0-0.* |

* = Color PU = Packaging Unit

01 = Satin Chrome, 5 = Dark Bronze PC, 6 = Black PC, 7 = White PC, 28 = Pewter

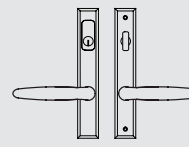
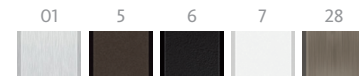

K-U5492-Z1-0.*

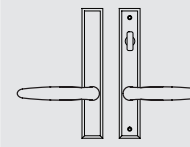

K-U5446-Z0-0.*

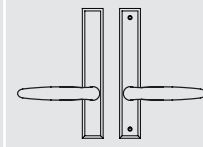

K-U5410-Z0-0.*

Additional information

- Unassembled zamac trim kits
- US-cylinder with standard 5 pins Schlage "C" keyway
- 90° locking with thumb-turn
- Self-centering 8mm spindle

- Stainless steel set screw on levers to secure spindle
- Patented handle clipping system
- Kit for 1 3/4" and 2 1/4" thick doors
- US-cylinder above handle

VENICE Handle & 30mm Plate



VENICE Solid Brass Trim Kits

| Description | PU | Part Number |
|---|----|----------------|
| Handle sets for active doors with US-cylinder | 1 | K-U3692-01-0-* |
| Handle sets for semi-active doors | 1 | K-U3646-00-0-* |
| Handle sets for fixed doors | 1 | K-U3610-00-0-* |

* = Color PU = Packaging Unit

01 = Satin Chrome, 03 = Polished Brass, 04 = Antique Brass, 05 = Oil Rubbed Bronze, 11 = Satin Nickel, 25 = Dark Bronze, 28 = Pewter

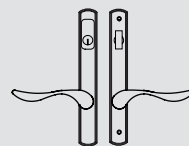
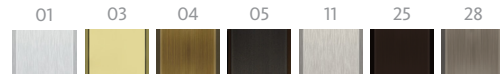

K-U3692-01-0-*

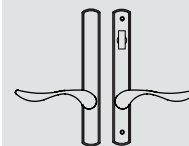

K-U3646-00-0-*

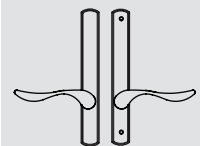

K-U3610-00-0-*

Additional information

- Unassembled solid brass trim kits
- US-cylinder with standard 5 pins Schlage "C" keyway
- 90° locking with thumb-turn
- Self-centering 8mm spindle

- Stainless steel set screw on levers to secure spindle
- Patented handle clipping system
- Kit for 1 3/4" and 2 1/4" thick doors
- US-cylinder above handle



VENICE Zamac Trim Kits

| Description | PU | Part Number |
|---|----|----------------|
| Handle sets for active doors with US-cylinder | 1 | K-U5692-Z1-0-* |
| Handle sets for semi-active doors | 1 | K-U5646-Z0-0-* |
| Handle sets for fixed doors | 1 | K-U5610-Z0-0-* |

* = Color PU = Packaging Unit

01 = Satin Chrome, 5 = Dark Bronze PC, 6 = Black PC, 7 = White PC, 28 = Pewter

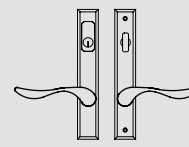
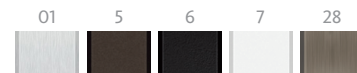

K-U5692-Z1-0-*

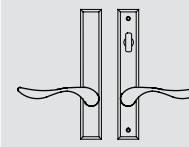

K-U5646-Z0-0-*

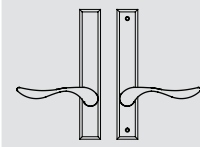

K-U5610-Z0-0-*

Additional information

- Unassembled zamac trim kits
- US-cylinder with standard 5 pins Schlage "C" keyway
- 90° locking with thumb-turn
- Self-centering 8mm spindle

- Stainless steel set screw on levers to secure spindle
- Patented handle clipping system
- Kit for 1 3/4" and 2 1/4" thick doors
- US-cylinder above handle



Additional information

- Unassembled solid brass trim kits
- US-cylinder with standard 5 pins Schlage "C" keyway
- 90° locking with thumb-turn
- Self-centering 8mm spindle

CAPRI Solid Brass Trim Kits

| Description | PU | Part Number |
|---|----|----------------|
| Handle sets for active doors with US-cylinder | 1 | K-U6292-01-0-* |
| Handle sets for semi-active doors | 1 | K-U6246-00-0-* |
| Handle sets for fixed doors | 1 | K-U6210-00-0-* |

* = Color PU = Packaging Unit

01 = Satin Chrome, 03 = Polished Brass, 04 = Antique Brass, 05 = Oil Rubbed Bronze, 11 = Satin Nickel, 25 = Dark Bronze, 28 = Pewter

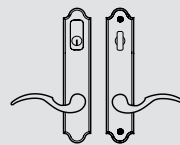
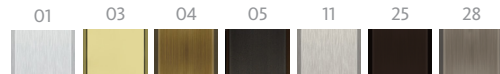

K-U6292-01-0-*

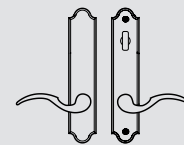

K-U6246-00-0-*

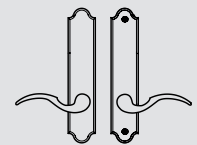

K-U6210-00-0-*

- Stainless steel set screw on levers to secure spindle
- Patented handle clipping system
- Kit for 1 3/4" and 2 1/4" thick doors
- US-cylinder above handle

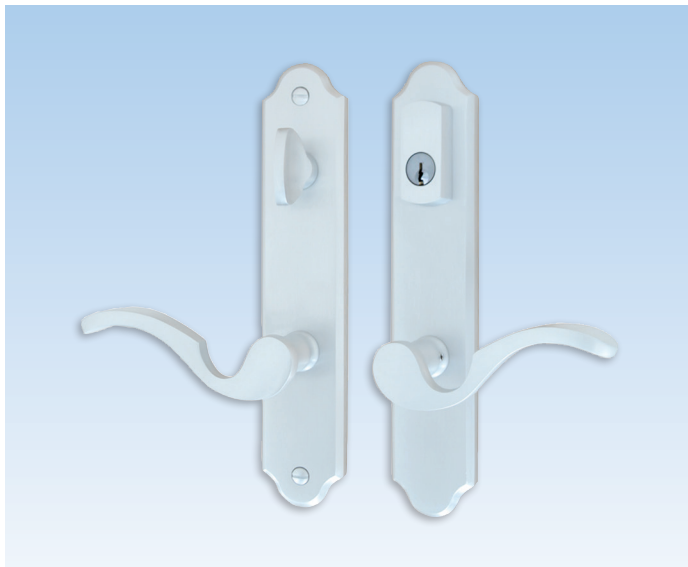

Additional information

- Unassembled zamac trim kits
- US-cylinder with standard 5 pins Schlage "C" keyway
- 90° locking with thumb-turn
- Self-centering 8mm spindle

CAPRI Zamac Trim Kits

| Description | PU | Part Number |
|---|----|----------------|
| Handle sets for active doors with US-cylinder | 1 | K-U7292-Z1-0-* |
| Handle sets for semi-active doors | 1 | K-U7246-Z0-0-* |
| Handle sets for fixed doors | 1 | K-U7210-Z0-0-* |

* = Color PU = Packaging Unit

5 = Dark Bronze PC, 6 = Black PC, 7 = White PC

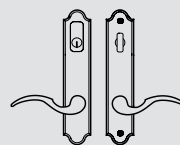
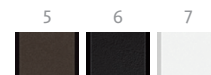

K-U7292-Z1-0-*

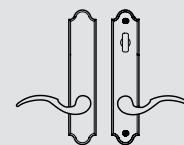

K-U7246-Z0-0-*

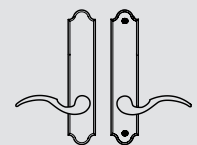

K-U7210-Z0-0-*

- Stainless steel set screw on levers to secure spindle
- Patented handle clipping system
- Kit for 1 3/4" and 2 1/4" thick doors
- US-cylinder above handle

TORINO Handles & 45mm Plates



TORINO Solid Brass Trim Kits

| Description | PU | Part Number |
|---|----|----------------|
| Handle sets for active doors with US-cylinder | 1 | K-U6492-01-0-* |
| Handle sets for semi-active doors | 1 | K-U6446-00-0-* |
| Handle sets for fixed doors | 1 | K-U6410-00-0-* |

* = Color PU = Packaging Unit

01 = Satin Chrome, 03 = Polished Brass, 04 = Antique Brass, 05 = Oil Rubbed Bronze, 11 = Satin Nickel, 25 = Dark Bronze, 28 = Pewter

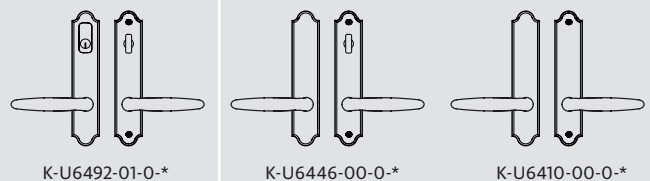
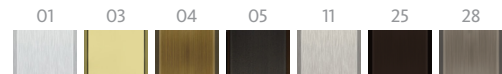

Additional information

- Unassembled solid brass trim kits
- US-cylinder with standard 5 pins Schlage "C" keyway
- 90° locking with thumb-turn
- Self-centering 8mm spindle

- Stainless steel set screw on levers to secure spindle
- Patented handle clipping system
- Kit for 1 3/4" and 2 1/4" thick doors
- US-cylinder above handle



TORINO Zamac Trim Kits

| Description | PU | Part Number |
|---|----|----------------|
| Handle sets for active doors with US-cylinder | 1 | K-U7492-Z1-0-* |
| Handle sets for semi-active doors | 1 | K-U7446-Z0-0-* |
| Handle sets for fixed doors | 1 | K-U7410-Z0-0-* |

* = Color PU = Packaging Unit

01 = Satin Chrome, 5 = Dark Bronze, 6 = Black, 7 = White, 28 = Pewter

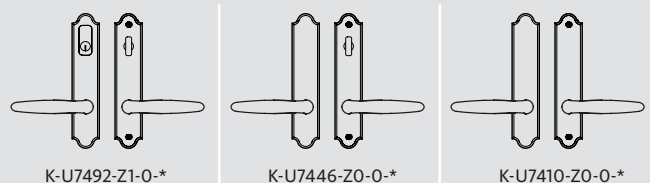

Additional information

- Unassembled zamac trim kits
- US-cylinder with standard 5 pins Schlage "C" keyway
- 90° locking with thumb-turn
- Self-centering 8mm spindle

- Stainless steel set screw on levers to secure spindle
- Patented handle clipping system
- Kit for 1 3/4" and 2 1/4" thick doors
- US-cylinder above handle

VENICE Handle & 45mm Plate



Additional information

- Unassembled solid brass trim kits
- US-cylinder with standard 5 pins Schlage "C" keyway
- 90° locking with thumb-turn
- Self-centering 8mm spindle



Additional information

- Unassembled zamac trim kits
- US-cylinder with standard 5 pins Schlage "C" keyway
- 90° locking with thumb-turn
- Self-centering 8mm spindle

VENICE Solid Brass Trim Kits

| Description | PU | Part Number |
|---|----|----------------|
| Handle sets for active doors with US-cylinder | 1 | K-U6692-01-0-* |
| Handle sets for semi-active doors | 1 | K-U6646-00-0-* |
| Handle sets for fixed doors | 1 | K-U6610-00-0-* |

* = Color PU = Packaging Unit

01 = Satin Chrome, 03 = Polished Brass, 04 = Antique Brass, 05 = Oil Rubbed Bronze, 11 = Satin Nickel, 25 = Dark Bronze, 28 = Pewter

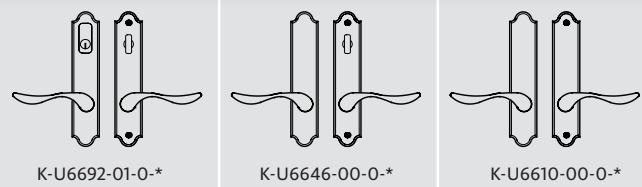
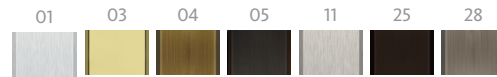

- Stainless steel set screw on levers to secure spindle
- Patented handle clipping system
- Kit for 1 3/4" and 2 1/4" thick doors
- US-cylinder above handle

VENICE Zamac Trim Kits

| Description | PU | Part Number |
|---|----|----------------|
| Handle sets for active doors with US-cylinder | 1 | K-U7692-Z1-0-* |
| Handle sets for semi-active doors | 1 | K-U7646-Z0-0-* |
| Handle sets for fixed doors | 1 | K-U7610-Z0-0-* |

* = Color PU = Packaging Unit

01 = Satin Chrome, 5 = Dark Bronze PC, 6 = Black PC, 7 = White PC, 28 = Pewter

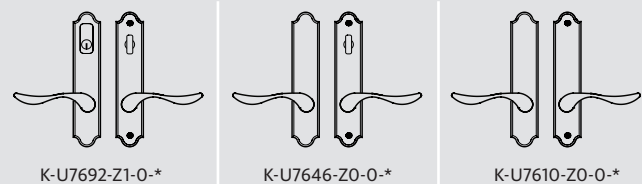
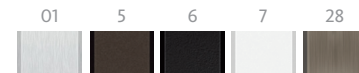

- Stainless steel set screw on levers to secure spindle
- Patented handle clipping system
- Kit for 1 3/4" and 2 1/4" thick doors
- US-cylinder above handle



Additional information

- Unassembled solid brass trim kits
- US-cylinder with standard 5 pins Schlage "C" keyway
- 90° locking with thumb-turn
- Self-centering 8mm spindle



Additional information

- Unassembled zamac trim kits
- US-cylinder with standard 5 pins Schlage "C" keyway
- 90° locking with thumb-turn
- Self-centering 8mm spindle

ROMA Solid Brass Trim Kits

| Description | PU | Part Number |
|---|----|----------------|
| Handle sets for active doors with US-cylinder | 1 | K-U4092-01-0-* |
| Handle sets for semi-active doors | 1 | K-U4046-00-0-* |
| Handle sets for fixed doors | 1 | K-U4010-00-0-* |
| Handle sets for Danalock smart lock | 1 | K-U4092-D0-0-* |
| Handle sets for Tedee smart lock | 1 | K-U4092-T1-0-* |

* = Color PU = Packaging Unit

11 = Satin Nickel, 25 = Dark Bronze, 28 = Pewter

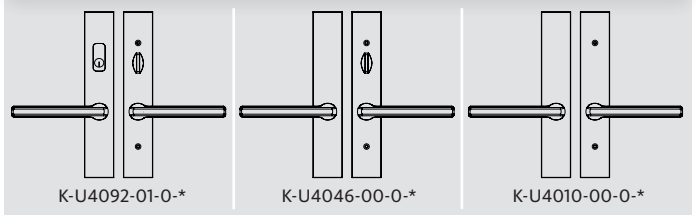
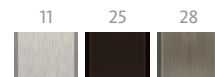

- Stainless steel set screw on levers to secure spindle
- Patented handle clipping system
- Kit for 1 3/4" and 2 1/4" thick doors
- US-cylinder above handle
- Compatible with Danalock V3 and Tedee smart locks

ROMA Zamac Trim Kits

| Description | PU | Part Number |
|---|----|----------------|
| Handle sets for active doors with US-cylinder | 1 | K-U9092-Z1-0-* |
| Handle sets for semi-active doors | 1 | K-U9046-Z0-0-* |
| Handle sets for fixed doors | 1 | K-U9010-Z0-0-* |
| Handle sets for Danalock smart lock | 1 | K-U9092-D0-0-* |
| Handle sets for Tedee smart lock | 1 | K-U9092-T1-0-* |

* = Color PU = Packaging Unit

6 = Black PC

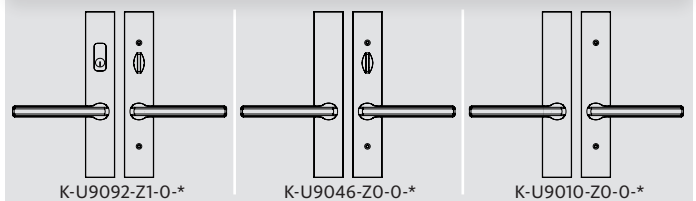

- Stainless steel set screw on levers to secure spindle
- Patented handle clipping system
- Kit for 1 3/4" and 2 1/4" thick doors
- US-cylinder above handle
- Compatible with Danalock V3 and Tedee smart locks

BERLIN Handle & 65mm Plates



BERLIN Solid Brass Trim Kits

| Description | PU | Part Number |
|---|----|----------------|
| Handle sets for active doors with US-cylinder | 1 | K-U2592-01-0-* |
| Handle sets for semi-active doors | 1 | K-U2546-00-0-* |
| Handle sets for fixed doors | 1 | K-U2510-00-0-* |
| Handle sets for Danalock smart lock | 1 | K-U2592-D0-0-* |
| Handle sets for Tedee smart lock | 1 | K-U2592-T1-0-* |

* = Color PU = Packaging Unit

11 = Satin Nickel, 28 = Pewter

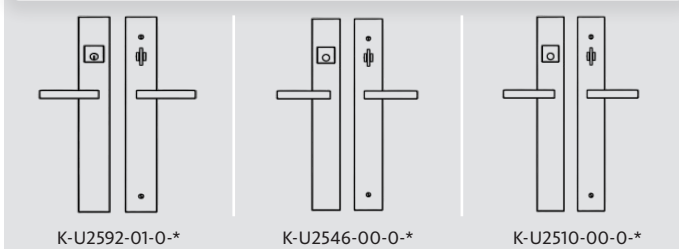
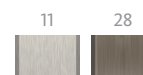

Additional information

- Unassembled Solid Brass trim kits
- US-cylinder with standard 5 pins Schlage "C" keyway
- New snapping mechanism for the 90° locking with thumb-turn
- Self-centering 8mm spindle
- Stainless steel set screw on levers to secure spindle
- Patented handle clipping system
- Kit for 1 3/4" and 2 1/4" thick doors
- US-cylinder above handle
- Compatible with Danalock V3 and Tedee smart locks

- Active trim kits are converted to Semi-Active and Dummy using a pre-assembled cylinder plug and screw-in Dummy brackets (included in the kits)



Additional information

- Unassembled Zamac trim kits
- US-cylinder with standard 5 pins Schlage "C" keyway
- New snapping mechanism for the 90° locking with thumb-turn
- Self-centering 8mm spindle
- Stainless steel set screw on levers to secure spindle
- Patented handle clipping system
- Kit for 1 3/4" and 2 1/4" thick doors
- US-cylinder above handle
- Compatible with Danalock V3 and Tedee smart locks

BERLIN Zamac Trim Kits

| Description | PU | Part Number |
|---|----|----------------|
| Handle sets for active doors with US-cylinder | 1 | K-U8592-Z1-0-* |
| Handle sets for semi-active doors | 1 | K-U8546-Z0-0-* |
| Handle sets for fixed doors | 1 | K-U8510-Z0-0-* |
| Handle sets for Danalock smart lock | 1 | K-U8592-D0-0-* |
| Handle sets for Tedee smart lock | 1 | K-U8592-T1-0-* |

* = Color

PU = Packaging Unit

5 = Dark Bronze PC, 6 = Black PC

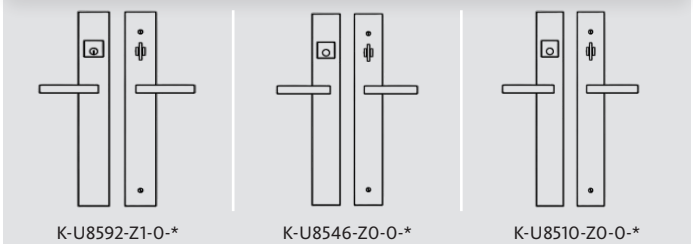

- Active trim kits are converted to Semi-Active and Dummy using a pre-assembled cylinder plug and screw-in Dummy brackets (included in the kits)

BELCANTO Handles & US Rosettes

for Door Lock



US rosettes

| Description | PU | Part Number |
|---|----|----------------|
| US lock kit for DB | 1 | K-C0370-00-0-* |
| US lock cyl. kit without knob for Danalock Smart Lock | 1 | K-C0370-D0-0-* |
| US lock cyl. kit without knob for Tedee Smart Lock | 1 | K-C0370-T1-0-* |

* = Color PU = Packaging Unit

8B = Stainless Steel, 6 = Black



Additional information

- Made of stainless steel
- Fastening kit included for 1 3/4" and 2 1/4" doors
- Foam gasket
- Compatible with smart lock (Danalock V3)
- For doors thicker than 2 1/4" up to 2 3/4" use M5 x 80mm (not included) and 90mm cylinder (6-C0971-90-0-1)
- For doors thicker than 2 3/4" up to 3" use M5 x 90mm (not included) and 90mm cylinder (6-C0971-90-0-1)
- US lock cyl. kit for Smart Lock comes without knob and allen key



Belcanto Handle Set

| Description | PU | Part Number |
|-----------------------------------|----|----------------|
| Kit of inside and outside handles | 1 | K-C9071-00-0-* |

* = Color PU = Packaging Unit

8B = Stainless Steel, 6 = Black



Additional information

- Handles and Rosettes made of stainless steel
- Fastening kit included for 1 3/4" and 2 1/4" doors
- Fixed lever spring loaded - can't be lifted
- 8mm square spindle x 110 mm included
- Concealed fixing screws
- Compatible with smart lock (Danalock V3)
- For doors 3" use screws (9-C0570-90-0-1) and 130mm spindle (9-U8100-30-0-8)

Smart locks

for Door Lock

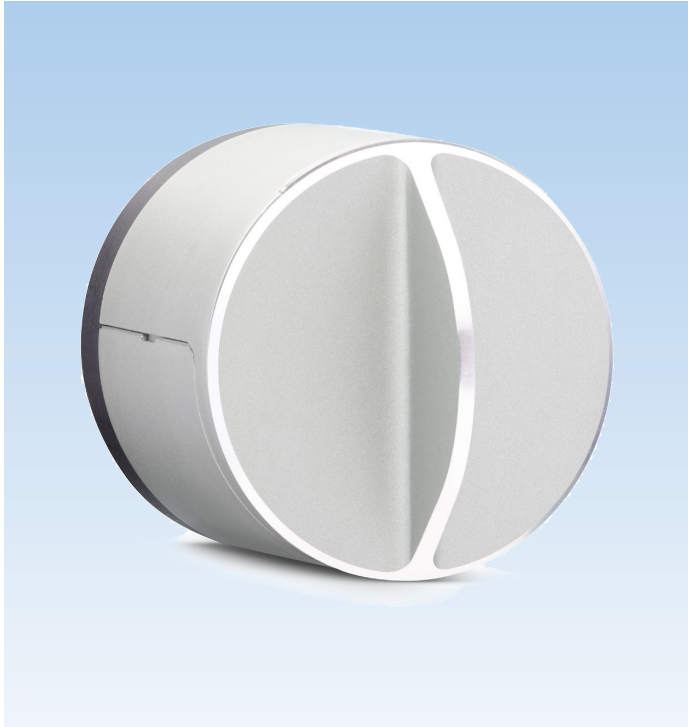

Smart lock

| Description | PU | Part Number |
|-----------------------|----|---------------------|
| Danalock V3 Z-Wave | 1 | K-C0380-00-0-1 |
| Danalock V3 Bluetooth | 1 | K-C0380-01-0-* |
| * = Color | | PU = Packaging Unit |
| 1 = Silver, 6 = Black | | |



Additional information

- 4 X CR123A batteries (included)
- Bluetooth 4.2 (Danalock app)
- Z-Wave (Automation hub - Only available in Silver finish)
- 256bit AES encryption level
- No cut-out modification required (retro-fit)
- Compatible with 55,65 mm plates and US rosettes

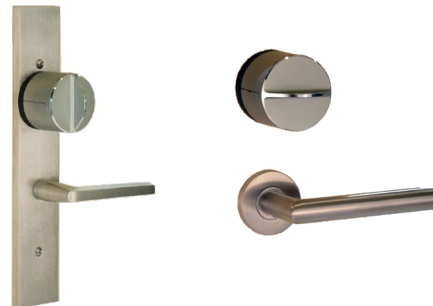

Bluetooth keypad

| Description | PU | Part Number |
|-----------------------|----|---------------------|
| Danapad V3 | 1 | 6-C9407-00-0-X |
| * = Color | | PU = Packaging Unit |
| 1 = Silver, 6 = Black | | |



Additional information

- 4 X AAA batteries (included)
- Bluetooth 4.2
- 256bit AES encryption level
- Compatible with smart lock (Danalock V3) and Universal Module



Danabridge Remote Access

| Description | PU | Part Number |
|---------------|----|----------------|
| Danabridge V3 | 1 | 6-C9402-00-0-0 |

Additional information

- 53 mm x 53 mm x 32 mm / Weighs 36 g
- USB power supply
- Add remote access to smart locks (Danalock or Universal Module)
- 2 Smart locks can be controlled with one Danabridge (via Bluetooth 4.2)
- Communication with Wi-Fi 802.11b/g/n



Danalock Accessories

| Description | PU | Part Number |
|---------------------------|----|----------------|
| Danalock black inner ring | 1 | 9-C0553-00-0-6 |



Danalock Accessories

| Description | PU | Part Number |
|-------------|----|----------------|
| U Bracket | 1 | 9-C0552-00-0-6 |

Additional information

- Replacement part for K-C0380-00-0-*



Danalock Accessories

| Description | PU | Part Number |
|----------------------|----|----------------|
| M4 button hex screws | 4 | 9-C0967-04-0-8 |

Additional information

- Replacement part for K-C0380-00-0-*



Danalock Accessories

| Description | PU | Part Number |
|--------------|----|----------------|
| Green Insert | 1 | 9-C0558-00-0-0 |

Additional information

- Replacement part for K-C0380-00-0-*

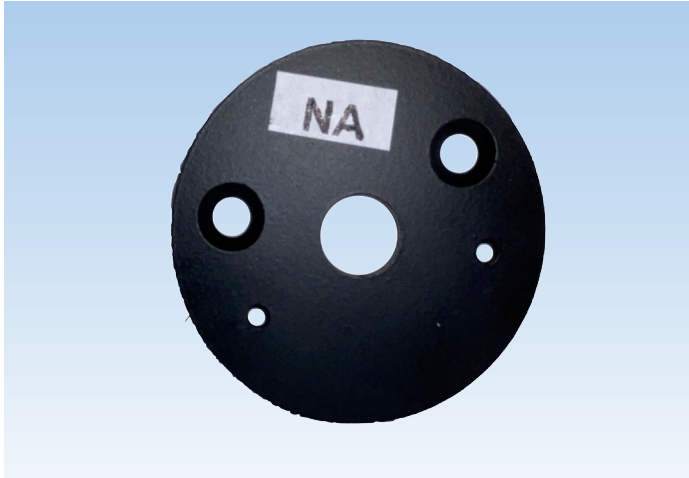

Danalock Accessories

| Description | PU | Part Number |
|-----------------|----|----------------|
| Black spacer NA | 1 | 9-C0545-00-0-6 |

Additional information

- Replacement part for K-C0380-XX-0-*

Smart locks

for Door Lock



Smart lock

| Description | PU | Part Number |
|-----------------------|----|----------------|
| Tedee PRO Smart Lock | 1 | 6-C9370-00-0-* |
| PU = Packaging Unit | | |
| 1 = Silver, 6 = Black | | |



Additional information

- Rechargeable 3000 mAh LiPo battery (included)
- Bluetooth BLE 5.0 2,4 GHz (Tedee app) and Internet connection
- Security TLS 1.3
- Compatible with 55,65 mm plates and US rosettes



Tedee Smart lock remote access (Wi-Fi)

| Description | PU | Part Number |
|---------------------|----|----------------|
| Tedee Smart Bridge | 1 | 6-C9382-00-0-7 |
| PU = Packaging Unit | | |

Additional information

- Dimensions 63.5 x 63.5 x 28 mm / Weight 51.6g
- Power connection socket plug (included) or micro-USB (cable not included)
- Wi-Fi 2.4 GHz and 5.0 GHz
- Bluetooth 5.0 2.4 GHz
- Security TLS 1.3
- Compatible with Tedee smart lock 6-C9370-00-0-X and Bluetooth Keypad 6-C9387-00-0-6
- Works with smart home systems



Bluetooth keypad

| Description | PU | Part Number |
|---------------------|----|----------------|
| Tedee Keypad | 1 | 6-C9387-00-0-6 |
| PU = Packaging Unit | | |

Additional information

- 3 X AAA batteries (included)
- Bluetooth 5.0 2,4 GHz
- Security TLS 1.3
- Up to 100 unique PINS
- Backlighted buttons, Sound signal, Bell button
- IP65 protection class
- Compatible with Tedee smart lock 6-9370-00-0-X and bridge 6-C9382-00-0-7

Strike Plates

for Door Lock

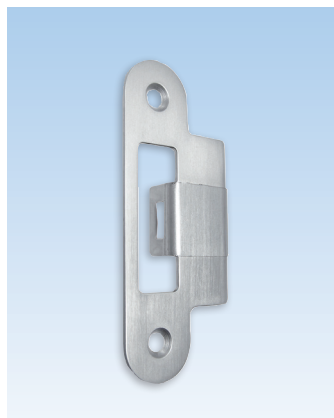

Top and Bottom Striker with Extended Lip

| Description | PU | Part Number |
|---|----|---------------------|
| Latchbolt strike plate for 45mm (1 3/4") thick doors | 10 | 9-C4776-45-0-* |
| Latchbolt strike plate for 57mm (2 1/4") thick doors | 10 | 9-C4776-57-0-* |
| * = Color | | PU = Packaging Unit |
| 03 = Polished Brass, 04 = Antique Brass, 5 = Dark Bronze, 6 = Black, 11 = Satin Nickel, 28 = Pewter | | |
| | | |

Additional information

- Solid brass (03, 04, 28) or stainless steel (5, 6, 11)
- Non-handed
- With clear protective film
- Available in handle matching finishes
- Two #8 x 5/8 FH/PH screws included
- For use with GU-SECURY Automatic door lock



Middle Striker with Extended Lip

| Description | PU | Part Number |
|---|----|---------------------|
| Latch and deadbolt strike plate for 45mm (1 3/4") thick doors | 10 | 9-C4777-45-0-* |
| Latch and deadbolt strike plate for 57mm (2 1/4") thick doors | 10 | 9-C4777-57-0-* |
| * = Color | | PU = Packaging Unit |
| 03 = Polished Brass, 04 = Antique Brass, 5 = Dark Bronze, 6 = Black, 11 = Satin Nickel, 28 = Pewter | | |
| | | |

Additional information

- Solid brass (03, 04, 28) or stainless steel (5, 6, 11)
- Non-handed
- With clear protective film
- Available in handle matching finishes
- Two #8 x 5/8 FH/PH screws included
- For use with GU-SECURY SH2, S-Bolt, Automatic and mortise door locks

Strike Plates

for Door Lock

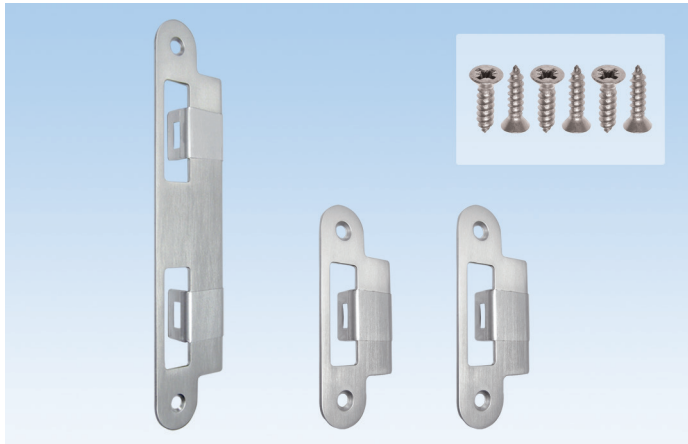

Bag of Strike Plates

| Description | PU | Part Number |
|--|----|----------------|
| Bag of strike plates for 45mm (1 3/4") thick doors | 50 | K-C4774-45-0-* |
| Bag of strike plates for 57mm (2 1/4") thick doors | 50 | K-C4775-57-0-* |

* = Color PU = Packaging Unit

03 = Polished Brass, 04 = Antique Brass, 5 = Dark Bronze, 6 = Black, 11 = Satin Nickel, 28 = Pewter

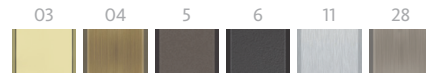

Additional information

- Solid brass (03, 04, 28) or stainless steel (5, 6, 11)
- Bag contains:
 - 1 middle striker with extended lip and clear protective film
 - 2 top and bottom strikers with extended lip and clear protective film
 - 6 screws
- Non-handed
- Available in handle matching finishes
- For use with GU-SECURY Automatic door locks

03
2

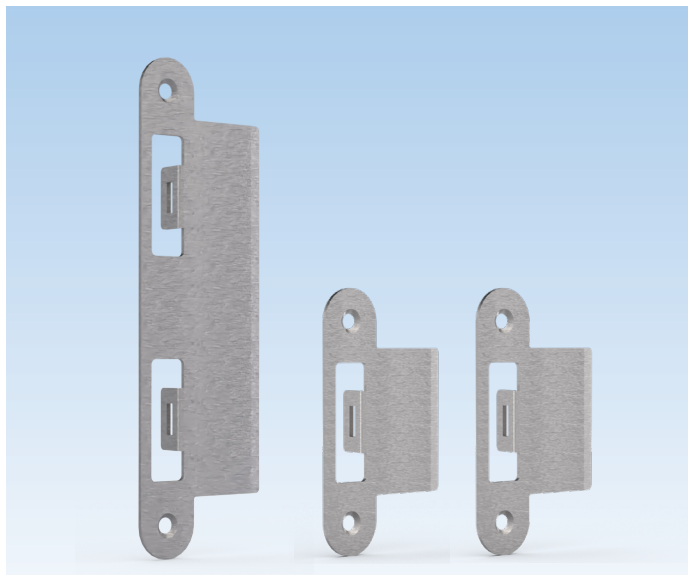

Bag of Strike Plates

| Description | PU | Part Number |
|--|----|----------------|
| Bag of strike plates for 76mm (3") thick doors | 1 | K-C4777-59-0-* |

* = Color PU = Packaging Unit

8B = Stainless Steel, 6 = Black



Additional information

- Made in stainless steel
- Bag contains:
 - 1 middle striker with extended lip
 - 2 top and bottom strikers with extended lip
- Non-handed
- For use with GU-SECURY Automatic door locks
- Six #8 x 5/8 FH/PH screws included

Strike Plates

for Door Lock

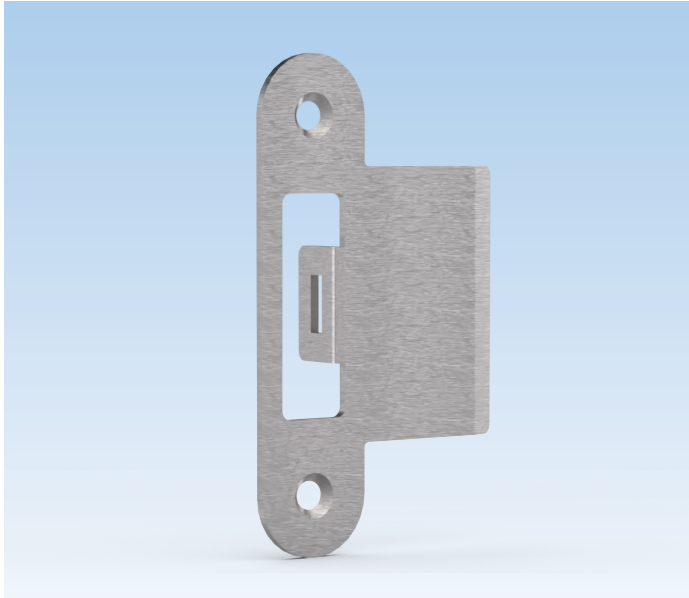

Top and Bottom Striker with Extended Lip

| Description | PU | Part Number |
|--|----|----------------|
| Latchbolt strike plate for 76mm (3") thick doors | 10 | 9-C4716-59-0-* |

* = Color

PU = Packaging Unit

8B = Stainless Steel, 6 = Black



Additional information

- Made in stainless steel
- Non-handed
- Two #8 x 5/8 FH/PH screws not included
- For use with GU-SECURY Automatic door lock

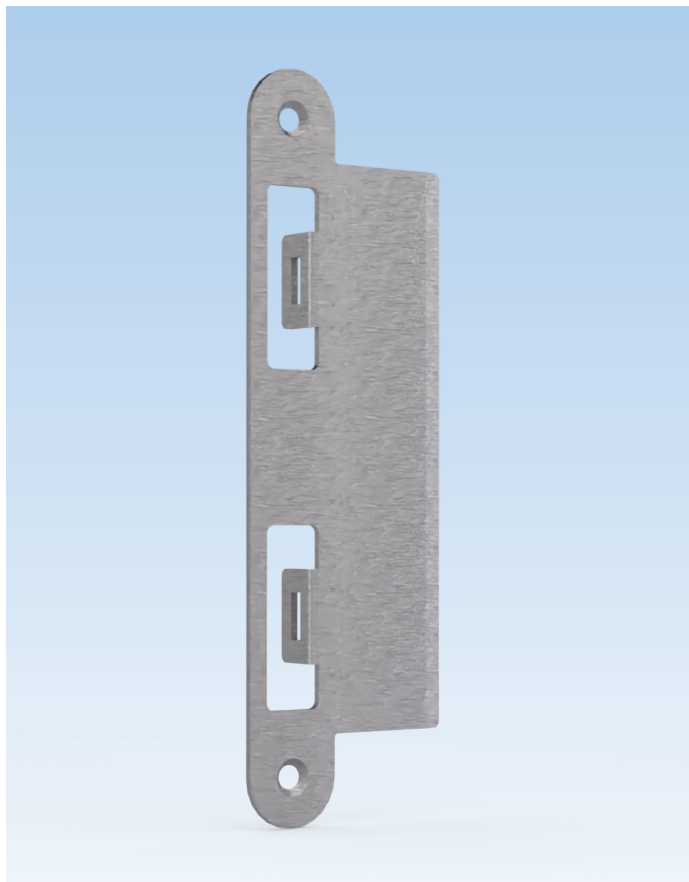

Middle Striker with Extended Lip

| Description | PU | Part Number |
|---|----|----------------|
| Latch and deadbolt strike plate for 76mm (3") thick doors | 10 | 9-C4717-59-0-* |

* = Color

PU = Packaging Unit

8B = Stainless Steel, 6 = Black



Additional information

- Made in stainless steel
- Non-handed
- Two #8 x 5/8 FH/PH screws not included
- For use with GU-SECURY Automatic door lock



Torx 15 T-Key

| Description | Color | PU | Part Number |
|---------------------|-------|----|----------------|
| Torx key | Steel | 1 | H-00346-15-0-0 |
| PU = Packaging Unit | | | |

Additional information

- Used for connecting SH2 and Automatic extensions



4mm Allen T-Key

| Description | Color | PU | Part Number |
|---------------------|-------|----|----------------|
| Allen key | Steel | 1 | H-00345-04-0-0 |
| PU = Packaging Unit | | | |

Additional information

- Used for reversing Automatic latchbolts on GU-SECURY Automatic lock and extension



Fastening Screws

| Description | Color | PU | Part Number |
|---------------------|-----------------|------|----------------|
| D1 screws | Stainless Steel | 1000 | 9-C5362-32-0-8 |
| PU = Packaging Unit | | | |

Additional information

- Stainless steel lock fastening screws
- Type D1 with self-drilling spiral point and high duplex thread with "Quadrex" socket
- Sharp tip for quick drive



Handle Set Color Chips

| Description | PU | Part Number |
|-------------|----|----------------|
| Color chips | 1 | K-C4780-00-0-0 |

* = Color PU = Packaging Unit

01 = Satin Chrome, 03 = Polished Brass, 04 = Antique Brass, 05 = Oil Rubbed Bronze, 5 = Dark Bronze, 6 = Black, 7 = White, 11 = Satin Nickel, 25 = Dark Bronze, 28 = Pewter

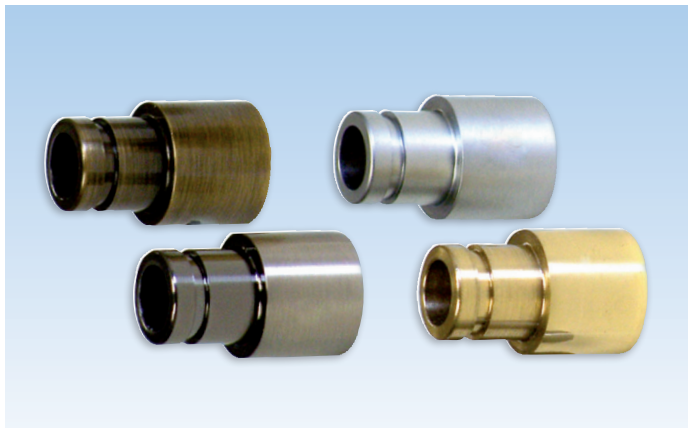

Handle Extenders

| Description | PU | Part Number |
|------------------|----|----------------|
| Handle extenders | 1 | 9-C0695-00-0-* |

* = Color PU = Packaging Unit

01 = Satin Chrome, 03 = Polished Brass, 04 = Antique Brass, 05 = Oil Rubbed Bronze, 5 = Dark Bronze, 6 = Black, 25 = Dark Bronze, 28 = Pewter



Additional information

- Made of solid brass
- Use with our solid brass handle sets
- Extends 18mm

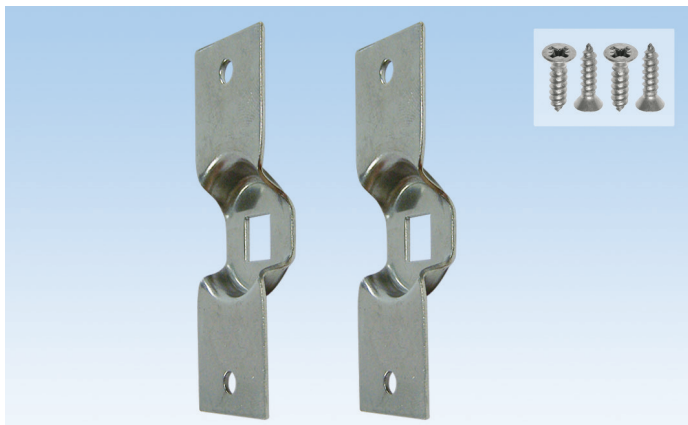

Fixing Plate for Dummy Trim Kits

| Description | PU | Part Number |
|---|----|----------------|
| Fixing plate used for fixed door handle | 50 | 9-U8210-00-0-3 |

PU = Packaging Unit

Additional information

- Made of zinc plated steel
- Bag of two dummy plates and four #6 x 5/8" FH/PH screws
- Included with Handle Dummy kits
- Part not required for Active & Semi-Active handles
- Fixing in the door

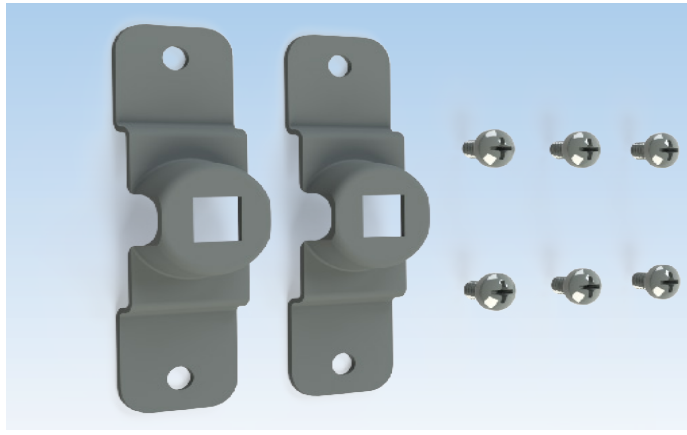

Fixing Plate for Dummy Trim Kits with 55 and 65mm plate

| Description | PU | Part Number |
|----------------------------------|----|----------------|
| Fixing Plate for Dummy trim kits | 1 | K-C0973-00-0-0 |
| PU = Packaging Unit | | |

Additional information

- Made of Zinc plated steel
- Bag of two dummy plates and six #6 x 5/8" FH/PH screws
- Included with 55 and 65mm plate Handle Dummy Kits
- Part not required for active and semi-active handles
- Fixing in the plate

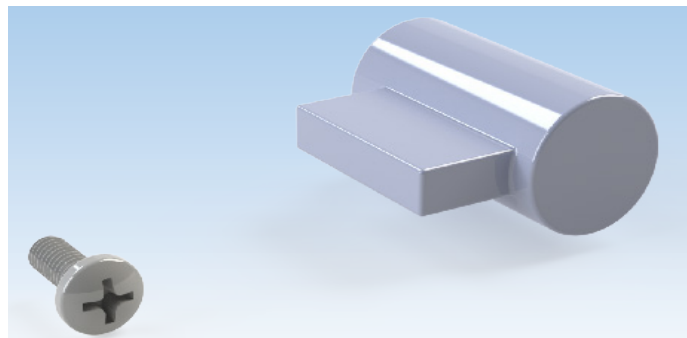

Dummy conversion kit

| Description | PU | Part Number |
|----------------------|----|---------------------|
| Dummy conversion kit | 1 | K-C0971-00-0-* |
| * = Color | | PU = Packaging Unit |

1 = Silver 25 = Dark Bronze



Additional information

- Made of Brass
- Bag of one dummy cylinder and one M4 x 10mm FH/PH screws
- Pre-installed with dummy and semi-active handles with 65mm plate
- Part not required for active handles

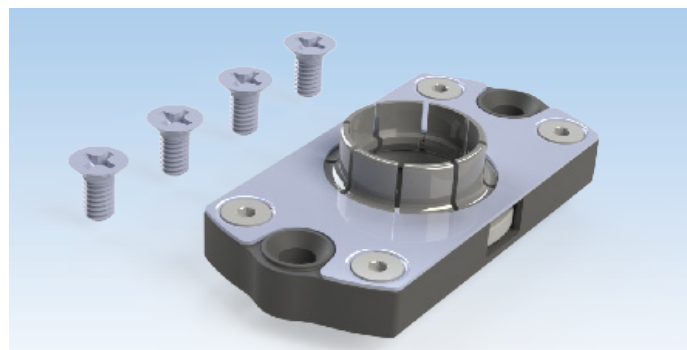

Replacement Snap & Turn box

| Description | PU | Part Number |
|---------------------|----|----------------|
| Snap & Turn Box | 1 | K-C2057-00-0-0 |
| PU = Packaging Unit | | |

Additional information

- Bag of one box and four M4 x 8mm FH/PH screws
- Included with handle sets with 65mm plate

Accessories

for Lever Handle

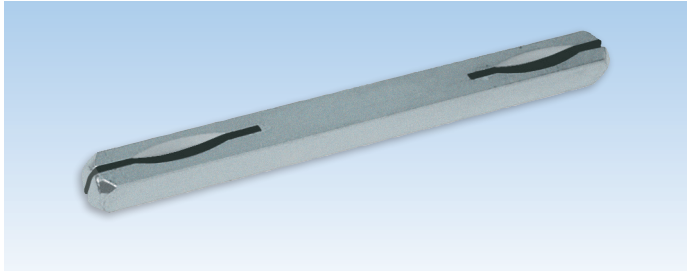

| 8mm Spindle | | | |
|--|------|----|----------------|
| Description | | PU | Part Number |
| 8 x 8 x 120mm spindle for 41-57mm thick doors <i>(1 spindle is supplied with door handle kit)</i> | Zinc | 10 | 9-U8100-20-0-8 |
| 8 x 8 x 130mm spindle for 57-76mm thick doors | Zinc | 10 | 9-U8100-30-0-8 |
| PU = Packaging Unit | | | |

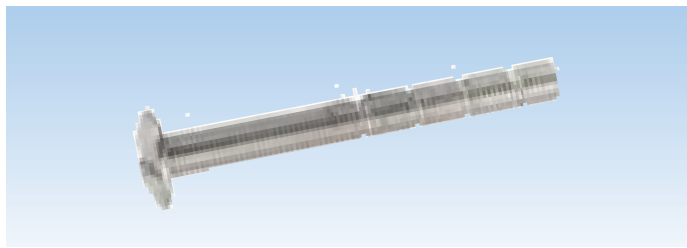

① For 41-76 mm thick doors

| Re-cuttable M5 Screw | | | |
|---|--|---------------------|----------------|
| Description | | PU | Part Number |
| ① M5 x 90mm screws <i>(2 screws are supplied with door handle kit)</i> | | 1 | 9-U2510-90-R-* |
| * = Color | | PU = Packaging Unit | |
| 01 = Satin Chrome, 03 = Polished Brass, 04 = Antique Brass, 05 = Oil Rubbed Bronze, 5 = Dark Bronze, 6 = Black, 7 = White, 11 = Satin Nickel, 25 = Dark Bronze, 28 = Pewter | | | |
| | | | |

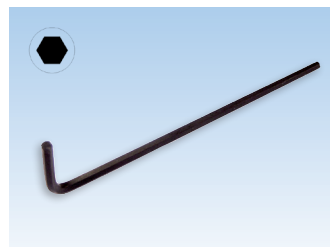

| Set Screw & Allen Key | | | |
|---|-----------------|----|----------------|
| Description | Color | PU | Part Number |
| M5 set screw <i>(2 screws are included with door handle kit)</i> | Stainless Steel | 1 | 9-U6008-05-0-1 |
| Allen key 2.5 x 20 x 100mm <i>(1 Allen key is supplied with door handle kit)</i> | Black | 1 | 9-C0955-10-0-0 |
| PU = Packaging Unit | | | |

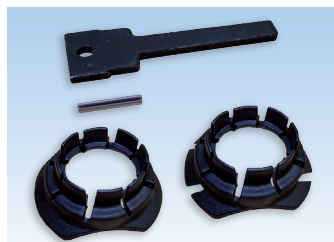

| Knob Tail Replacement Kits | | | |
|--|-------|----|----------------|
| Description | Color | PU | Part Number |
| 48mm knob tail with snap rings | Black | 1 | K-C0600-48-0-0 |
| 72mm recutable knob tail with snap rings | Black | 1 | K-C0600-72-0-0 |
| PU = Packaging Unit | | | |

Additional information

- Knob tail made of tempered steel
- Used for semi-active handle trim kits
- 48 mm for doors from 1 3/4" to 2 3/4"
- 72mm recutable for doors from 2 3/4" to 3 5/8"



Snap Rings

| Description | Color | PU | Part Number |
|-------------------------|-------|----|-----------------|
| Snap ring | Black | 1 | 9-C0645-02-0-6A |
| Snap ring – low profile | Black | 1 | 9-C0645-03-0-6 |

PU = Packaging Unit



Washers

| Description | Color | PU | Part Number |
|---|-------|----|----------------|
| Nylatron washer 0.25mm x 16mm (inner dia.) | Clear | 1 | 9-C0647-25-0-0 |
| Nylatron washer 0.5mm x 16mm (inner dia.) | Clear | 1 | 9-C0647-50-0-0 |
| Nylatron washer 1.0mm x 16mm (inner dia.) | Clear | 1 | 9-C0647-10-0-0 |

* = Color PU = Packaging Unit



“O” Ring

| Description | Color | PU | Part Number |
|---------------------------------------|-------|----|----------------|
| “O” ring 1.5mm x 16mm (inner dia.) | Black | 1 | 9-C0953-00-0-6 |

PU = Packaging Unit



Cylinders Schlage “C” Keyway

| Description | Color | PU | Part Number |
|--|-------------|----|-----------------|
| ① Cylinder with 52mm tail and set of three keys | Zinc | 1 | 6-C0971-52-0-1 |
| | Brass | 1 | 6-C0971-52-0-3 |
| | Dark Bronze | 1 | 6-C0971-52-0-25 |
| ② Cylinder with 64mm tail and set of three keys | Zinc | 1 | 6-C0971-64-0-1 |
| | Dark Bronze | 1 | 6-C0971-64-0-25 |
| ③ Cylinder with 90 mm tail and set of three keys | Zinc | 1 | 6-C0971-90-0-1 |
| | Brass | 1 | 6-C0971-90-0-3 |
| | Dark Bronze | 1 | 6-C0971-90-0-25 |

PU = Packaging Unit

Key Alike Cylinders Schlage “C” Keyway

| Description | Color | PU | Part Number |
|---|-------------|----|-----------------|
| ① Cylinder with 52mm tail and set of three keys | Zinc | 1 | 6-C0971-52-9-1 |
| | Brass | 1 | 6-C0971-52-9-3 |
| | Dark Bronze | 1 | 6-C0971-52-9-25 |
| ② Cylinder with 64mm tail and set of three keys | Zinc | 1 | 6-C0971-64-0-1 |
| | Dark Bronze | 1 | 6-C0971-64-0-25 |
| ③ Cylinder with 90mm tail and set of three keys | Zinc | 1 | 6-C0971-90-9-1 |
| | Brass | 1 | 6-C0971-90-9-3 |
| | Dark Bronze | 1 | 6-C0971-90-9-25 |

PU = Packaging Unit

- ① For 41-57 mm thick doors with plate 30,45,55mm
- ② For 41-57 mm thick doors with plate 65mm
- ③ For 41-76 mm thick doors

Accessories

for Lever Handle



Gasket 55mm

| Description | Color | PU | Part Number |
|---------------------------|-------|----|----------------|
| Gasket for active plate | Black | 1 | 6-C0825-55-0-6 |
| Gasket for inactive plate | Black | 1 | 6-C0826-55-0-6 |
| PU = Packaging Unit | | | |

Additional information

- Not compatible with Dummy Handle fixing Plates K-C0973-00-0-0. To use this product in a dummy handle configuration, use fixing plates 6-C0800-03-0-0

Accessories

for Lever Handle

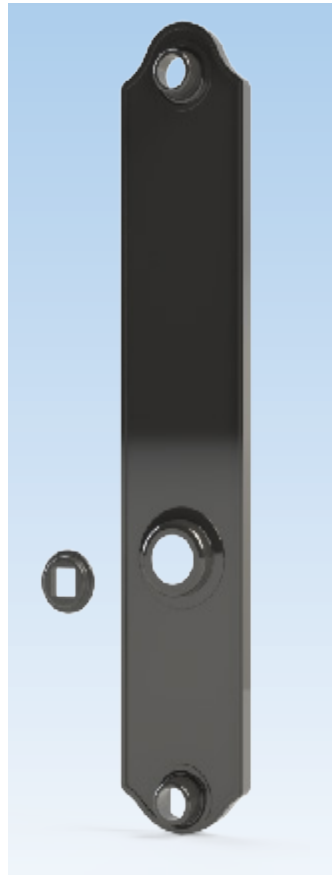
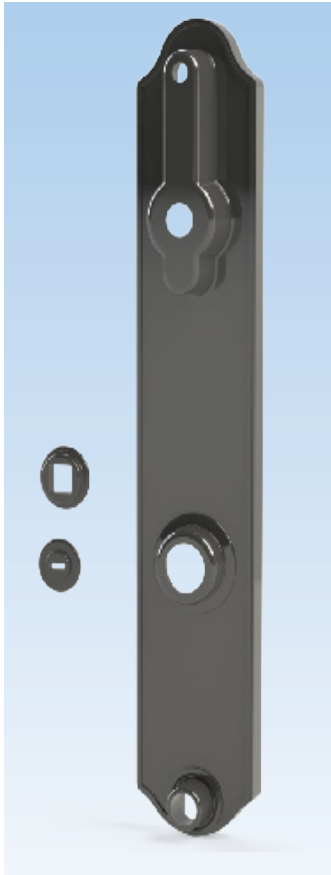

Gasket 45mm

| Description | Color | PU | Part Number |
|---------------------------|-------|----|----------------|
| Gasket for active plate | Black | 1 | 6-C0825-00-0-6 |
| Gasket for inactive plate | Black | 1 | 6-C0826-00-0-6 |
| PU = Packaging Unit | | | |

Accessories

for Strike Plate



Dust Cup Edge– 25mm

| Description | Color | PU | Part Number |
|-------------|-------|-----|----------------|
| Plastic cup | Black | 10 | 9-C4765-00-0-6 |
| | | 100 | 9-C4765-1C-0-6 |
| | | 500 | 9-C4765-5C-0-6 |

PU = Packaging Unit

Additional information

- Use for latch and 2 automatic latches (optional)
- Dimensions:
 - Length: 62mm
 - Width: 19.5mm
 - Depth: 25.8mm



Dust Cup without Edge – 15mm

| Description | Color | PU | Part Number |
|-------------|-------|-----|----------------|
| Plastic cup | Black | 10 | 9-C4765-0A-0-6 |
| | | 100 | 9-C4765-1C-A-6 |
| | | 500 | 9-C4765-5C-A-6 |

PU = Packaging Unit

Additional information

- Dimensions:
 - Length: 62mm
 - Width: 19.5mm
 - Depth: 16mm



Screws for Strike Plates

| Description | PU | Part Number |
|-------------------------|----|----------------|
| #8 x 5/8" (16mm) screws | 10 | K-C4763-16-6-* |

* = Color

PU = Packaging Unit

03 = Polished Brass, 04 = Antique Brass, 5 = Dark Bronze, 6 = Black, 11 = Satin Nickel, 28 = Pewter

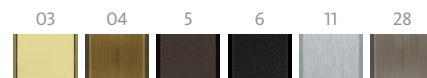

Additional information

- Bag of 6 screws for strike plates
- #8 x 5/8" FH/PH screws



Construction Handle Set

| Description | Color | PU | Part Number |
|---------------------|-------|----|----------------|
| Construction handle | Black | 25 | K-C9250-25-0-6 |
| PU = Packaging Unit | | | |

Additional information

- Reinforced nylon temporary door trim sets
- 8 x 8 x 90mm square spindle included
- 4.2 x 50mm screws included
- For 1 3/4" thick doors
- Locking/Unlocking from inside only



Construction Key

| Description | Color | PU | Part Number |
|---------------------|-------|----|----------------|
| Construction key | Black | 10 | 9-U0001-01-0-0 |
| PU = Packaging Unit | | | |

Additional information

The construction key is available for those who prefer to install the decorative hardware trim and lever sets on doors after the construction has been completed. Installing the escutcheon plates and levers in the final stage of construction prevents the decorative trim from becoming scratched or damaged.

The construction key has been designed to accommodate multipoint door hardware (8mm square), tilt-turn hardware (7mm square) and lift-slide hardware (10mm square).

Wood Mount Display

for Lever Handle



Wood Mount Display with Lever Handles

| Description | PU | Part Number |
|--------------------|----|----------------|
| Wood mount display | 1 | 6-C9618-00-0-9 |

* = Color PU = Packaging Unit

01 = Satin Chrome, 03 = Polished Brass, 04 = Antique Brass, 05 = Oil Rubbed Bronze, 5 = Dark Bronze, 6 = Black, 7 = White, 11 = Satin Nickel, 25 = Dark Bronze, 28 = Pewter



Additional information

- To be used with 30, 45 and 55mm escutcheons and Capri, Torino, Allegro, Venice or Roma handles
- When ordering, please pick handle, plate and finish

Wood Mount Display

for Lever Handle and Door Lock



Wood Mount Display with Door Lock and Handle

| Description | PU | Part Number |
|--|----|----------------|
| Wood mount display - 45mm (1 3/4") thick | 1 | K-C9615-00-0-9 |
| Wood mount display - Smart Lock | 1 | K-C9619-SL-0-9 |
| Wood mount display - Smart Lock Tedee | 1 | K-C9619-SL-T-9 |
| PU = Packaging Unit | | |

Additional information

- Wood mount complete with lever handle and SECURY Automatic sample gear
- To be used with 30, 45 and 55mm escutcheons and Capri, Torino, Allegro, Venice or Roma handle
- Roma handle with Danalock smart lock with K-C9619-SL-0-9
- Roma handle with Tedee smart lock with K-C9619-SL-T-9
- When ordering, please add note for escutcheon, handle, and finish

03
2

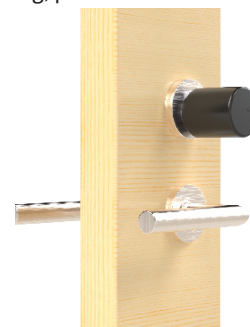

Wood Mount Display with US Rosette

| Description | PU | Part Number |
|--|----|----------------|
| Wood mount display - 45mm (1 3/4") thick | 1 | K-C9622-00-0-9 |
| Wood mount display - Danalock Smart Lock | 1 | K-C9621-SL-0-9 |
| Wood mount display - Tedee Smart Lock | 1 | K-C9621-SL-T-9 |
| PU = Packaging Unit | | |

Additional information

- Wood mount complete with lever handle and SECURY Automatic sample gear
- To be used with US Rosette and Belcanto Handles
- US Rosette with Danalock smart lock with K-C9621-SL-0-9
- US Rosette with Tedee smart lock with K-C9621-SL-T-9
- When ordering, please add note for finish

Wood Mount Display

for Lever Handle and Door Lock

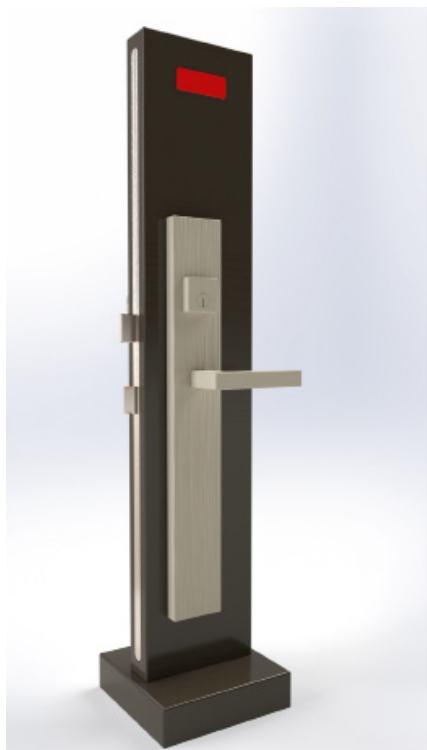

Wood Mount Display with Door Lock and Handle

| Description | PU | Part Number |
|---|----|----------------|
| Wood mount display – 65mm Plate | 1 | K-C9642-00-0-9 |
| Wood mount display – 65 mm Plate with Danalock Smart Lock | 1 | K-C9642-SL-0-9 |
| Wood mount display – 65 mm Plate with Tedee Smart Lock | 1 | K-C9642-SL-T-9 |
| PU = Packaging Unit | | |

Additional information

- Wood mount complete with lever handle and SECURY Automatic sample gear
- 65 mm plate with Tedee smart lock K-C9642-SL-T-9
- When ordering, please add note for finish





Lined area for notes.



WINDOW TECHNOLOGY
DOOR TECHNOLOGY
AUTOMATIC ENTRANCE SYSTEMS
BUILDING MANAGEMENT SYSTEMS

QUÉBEC / MARITIMES

Ferco Ferrures de Bâtiment Inc.
2000, Rue Berlier
Laval, QC H7L 4S4
Canada

T 450 973-1437
1 800 355-8810
F 450 973-7661
ferco@ferco.ca

ONTARIO / WESTERN PROVINCES

Ferco Architectural Hardware Inc.
T 905 282-9588
1 800 668-5310
F 905 282-9915

UNITED STATES

Ferco Architectural Hardware Inc.
T 1 800 927-1097
F 1 888 454-0161

www.ferco.ca

Securing technology for you

