

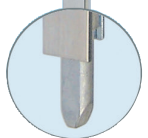

WINDOW TECHNOLOGY
DOOR TECHNOLOGY
AUTOMATIC ENTRANCE SYSTEMS
BUILDING MANAGEMENT SYSTEMS



DOOR TECHNOLOGY – ORDER CATALOG | SECTION 03.4



GU-SECURY S-Bolt Door Lock & Lever Handle



Securing technology for you







03.4

GU-SECURY S-Bolt Door Lock & Lever Handle

GU-SECURY S-Bolt

S-Bolt Active Door Lock	03.4.5
S-Bolt Inactive Door Lock	03.4.6
S-Bolt Extensions	03.4.7

HANDLES

Introduction	03.4.9
Finishes for handle set program	03.4.10

30mm Plate Series

ALLEGRO Trim Kits	03.4.12
TORINO Trim Kits	03.4.13
VENICE Trim Kits	03.4.14

45mm Plate Series

CAPRI Trim Kits	03.4.15
TORINO Trim Kits	03.4.16
VENICE Trim Kits	03.4.17

55mm Plate Series

ROMA Trim Kits	03.4.18
----------------------	---------

65mm Plate Series

BERLIN Trim Kits	03.4.19
------------------------	---------

Smart locks	03.4.21
Strike Plates	03.4.27
Latch and Deadbolt Blockers	03.4.28
Strike Cups	03.4.30

Accessories	03.4.31
Wood Mount Displays	03.4.40

GU-SECURY S-Bolt Locking System

for Single/Double Doors

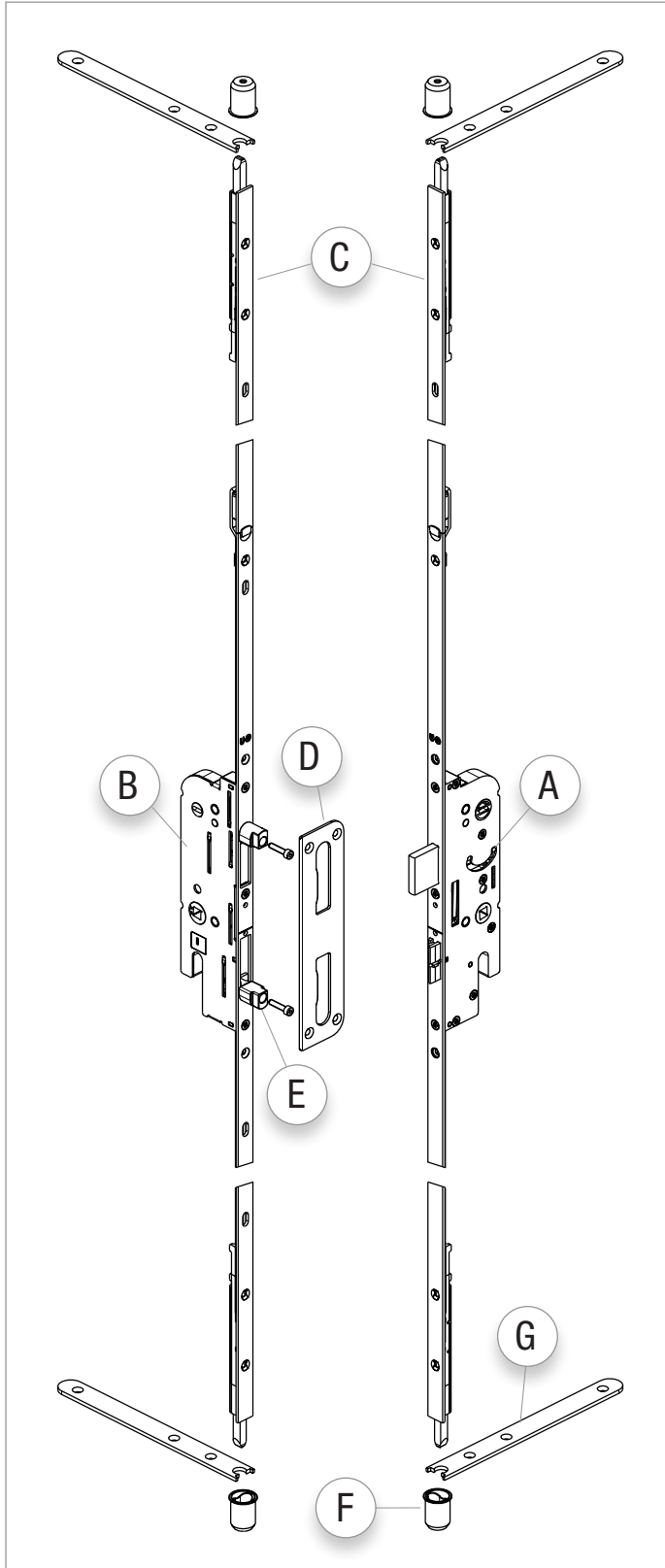

The Smart System for Double Doors

Ease of use, the system does not allow home owners to lock the active door unless the inactive door is fully locked. This guarantees that both doors are fully locked and secured.



Full 1" shootbolts offer deeper penetration into the head and sill



Easy to connect the extension to the lock



Latch and deadbolt blockers are design for intuitive operation
Latch and deadbolt blockers are designed to provide communication between the semi-active and active door panel so both panels are lock in the correct sequence



Reversible latch with build-in anti-slam feature



Additional active panel three point locking options are SECURY hookbolt or Automatic latchbolt

Position	Description	Part Number
A	SECURY S-Bolt active door lock	6-39571-XX-0-8B
B	SECURY S-Bolt inactive door lock	6-39570-XX-0-8B
C	SECURY S-Bolt extension	6-39572-XX-0-8B
D	Center latch and deadbolt strikeplate	9-C4779-XX-0-11
E	Latch and deadbolt blockers	K-19658-XX-0-6
F	Shoot bolt strike cups	9-C4306-XX-0-0
G	16mm reinforcing strip for 10mm rods 20mm reinforcing strip for 10mm rods	9-C4315-00-0-8B 9-C4316-00-0-8B

GU-SECURITY S-Bolt Active Door Lock

with Latch, Deadbolt and Shoot Bolt for Single/Double Doors



GU-SECURITY S-Bolt Active Door Lock for Lever Handle

Description	Color	PU	Part Number
Door lock with 50mm backset	Stainless Steel	5	6-39571-02-0-8B
Door lock with 60mm backset	Stainless Steel	5	6-39571-03-0-8B

PU = Packaging Unit

Additional information

- 3-point locking system for maximum security and protection against warping of the door panels
- Heavy duty mortise construction with reinforced lever return spring system
- Independent 90 degree locking and unlocking of deadbolt
- Lever controlled engaging and releasing the shoot bolts
- 1" (25mm) throw on deadbolt
- Two shoot bolts 1" (25mm) projection offer deeper penetration into the head and sill resulting in higher security and outstanding performance
- Non handed, latch with build-in failsafe (anti-slam) easily reversible
- Handle height 36" (915mm)
- 8mm spindle
- 92mm centres (spindle to cylinder)
- 16mm stainless steel faceplate
- Same hardware groove detail throughout our entire door lock program (router bits available)
- Used with shoot bolt extensions 6-39572-XX-0-8B

GU-SECURITY S-Bolt Inactive Door Lock

with Shoot Bolt for Double Doors



GU-SECURITY S-Bolt Inactive Door Lock for Lever Handle

Description	Color	PU	Part Number
Door lock with 50mm backset	Stainless Steel	5	6-39570-02-0-8B
Door lock with 60mm backset	Stainless Steel	5	6-39570-03-0-8B

PU = Packaging Unit

Additional information

- 2-point locking system for maximum security and protection against warping of the door panels
- Heavy duty mortise construction with reinforced lever return spring system
- 90° locking with thumb-turn
- Lever controlled engaging and releasing the shoot bolts
- Two shoot bolts 1" (25mm) projection offer deeper penetration into the head and sill resulting in higher security and outstanding performance
- Handle height 36" (915mm)
- 8mm spindle
- 92mm centres (spindle to cylinder)
- 16mm stainless steel faceplate
- Same hardware groove detail throughout our entire door lock program (router bits available)
- Used with shoot bolt extensions 6-39572-XX-0-8B
- Used with latch and deadbolt blockers K-19658-XX-0-6

S-Bolt Extensions

with Shoot Bolt



Extensions

Description	Color	PU	Part Number
Extension 825.5mm (32 1/2") Height range: min. 1846 (72 3/4") and max. 2100 (82 1/2")	Stainless Steel	10	6-39572-01-0-8B
Extension 1079.5mm (42 1/2") Height range: min. 2100 (82 1/2") and max. 2350 (92 1/2")	Stainless Steel	10	6-39572-02-0-8B
Extension 1333.5mm (52 1/2") Height range: min. 2350 (92 1/2") and max. 2604 (102 1/2")	Stainless Steel	10	6-39572-03-0-8B
Extension 1587.5mm (62 1/2") Height range: min. 2604 (102 1/2") and max. 2858 (112 1/2")	Stainless Steel	10	6-39572-04-0-8B
PU = Packaging Unit			

Additional information

- Shoot bolt 1" (25mm) projection offer deeper penetration into the head and sill resulting in higher security and outstanding performance
- 16mm stainless steel faceplate
- Used with SECURY S-Bolt door locks 6-39571-XX-0-8B (active) and 6-39570-XX-0-8B (inactive)



Additional Extension

Description	Color	PU	Part Number
Extension 369mm (14 1/2")	Stainless Steel	10	6-36960-01-0-8B
PU = Packaging Unit			

Additional information

- 16mm stainless steel faceplate
- Can be used with any S-Bolt extensions



Ferco lever handle sets are uniquely designed to operate on multipoint door locks. Our handle sets withstand the rigorous everyday operational wear & tear of engaging or disengaging multiple lock points. **Our handle sets are designed for long term use!**

- **Patented handle snap-rings** allow for handles to be shipped non-handed. The manufacturer no longer has to worry about ordering left or right, and will save on inventory.
- **Handle setscrews to fasten spindles** combined with the snap-ring will ensure the handle will stay tight on the door for a long time.
- **Self centering 8mm split Spindle** to make sure it is always centered into the door.
- **Longer Screw ports on escutcheons:** Ferco has added an interior sleeve port that will guide the M5 mm screw straight to the opposing exterior screw port.
- **Exterior O-ring on handle shaft** to prevent water from entering around the exterior handle.
- **Washers between handle and escutcheon** making sure the handle operation is and remains smooth.
- **Escutcheon Foam gasket** to prevent air and cold.
- **Rubber gasket** (Order separately) to prevent air and water leakage around the exterior escutcheon.
- **Schlage Cylinder with one tail for both 1 ¾” and 2 ¼” thick doors**
- **M5 handle set screws to fasten the escutcheons** included in every handle set kit.
- **Handle above cylinder or handle below cylinder option**
- **FERCO handle sets available** in Solid Brass or economical zinc die-cast material with selections in many plate designs, lever styles and finishes.

Finishes For Handle Set Program

- US-Cylinder Above Handle



	SOLID BRASS						ZAMAC					
	45mm PLATE			30mm PLATE			45mm PLATE			30mm PLATE		
	CAPRI	TORINO	VENICE	ALLEGRO	TORINO	VENICE	CAPRI	TORINO	VENICE	ALLEGRO	TORINO	VENICE
	K-U6292-01 K-U6246-00 K-U6210-00	K-U6492-01 K-U6446-00 K-U6410-00	K-U6692-01 K-U6646-00 K-U6610-00	K-U3192-01 K-U3146-00 K-U3110-00	K-U3492-01 K-U3446-00 K-U3410-00	K-U3692-01 K-U3646-00 K-U3610-00	K-U7292-Z1 K-U7246-Z0 K-U7210-Z0	K-U7492-Z1 K-U7446-Z0 K-U7410-Z0	K-U7692-Z1 K-U7646-Z0 K-U7610-Z0	K-U5192-Z1 K-U5146-Z0 K-U5110-Z0	K-U5492-Z1 K-U5446-Z0 K-U5410-Z0	K-U5692-Z1 K-U5646-Z0 K-U5610-Z0
	01	01	01	01	01	01		01	01	01	01	01
Satin Chrome												
	03	03	03	03	03	03						
Polished Brass												
	04	04	04	04	04	04						
Antique Brass												
	05	05	05	05	05	05						
Oil Rubbed Bronze												
							5	5	5	5	5	5
Dark Bronze PC												
							6	6	6	6	6	6
Black PC												
							7	7	7	7	7	7
White PC												
	11	11	11	11	11	11						
Satin Nickel												
	25	25	25	25	25	25						
Dark Bronze												
	28	28	28	28	28	28		28	28	28	28	28
Pewter												







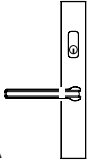
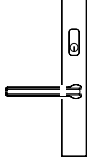

Colors on this document are graphic representation and may not be an exact match for the actual painted/plated hardware.
For color selection, material samples are available on request.

* information in this document can be modified without notice. Finishes Handle Sets Program_03-2021

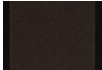
Finishes For Handle Set Program

- US-Cylinder Above Handle



	SOLID BRASS 55mm PLATE	ZAMAC 55mm PLATE	SOLID BRASS 65mm PLATE	ZAMAC 65mm PLATE
	 ROMA K-U4092-01 K-U4046-00 K-U4010-00	 ROMA K-U9092-Z1 K-U9046-Z0 K-U9010-Z0	 BERLIN K-U2592-Z1 K-U2546-Z0 K-U2510-Z0	 BERLIN K-U8592-Z1 K-U8546-Z0 K-U8510-Z0
Satin Chrome				
Polished Brass				
Antique Brass				
Oil Rubbed Bronze				
Dark Bronze PC				5 
Black PC		6 		6 
White PC				
Satin Nickel			11 	
Dark Bronze	25 			
Pewter	28 		28 	

Colors on this document are graphic representation and may not be an exact match for the actual painted/plated hardware. For color selection, material samples are available on request.

ALLEGRO Handles & 30mm Plates



ALLEGRO Solid brass Trim Kits

Description	PU	Part Number
Handle sets for active doors with US-cylinder	1	K-U3192-01-0-*
Handle sets for semi-active doors	1	K-U3146-00-0-*
Handle sets for fixed doors	1	K-U3110-00-0-*

* = Color PU = Packaging Unit

01 = Satin Chrome, 03 = Polished Brass, 04 = Antique Brass,
05 = Oil Rubbed Bronze, 11 = Satin Nickel, 25 = Dark Bronze, 28 = Pewter

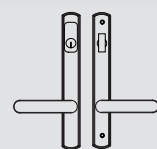
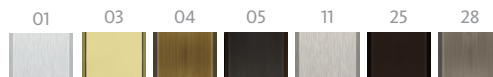

K-U3192-01-0-*

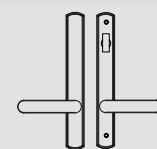

K-U3146-00-0-*

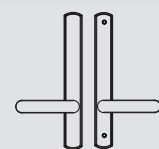

K-U3110-00-0-*

Additional information

- Unassembled solid brass trim kits
- US-cylinder with standard 5 pins Schlage "C" keyway
- 90° locking with thumb-turn
- Self-centering 8mm spindle

- Stainless steel set screw on levers to secure spindle
- Patented handle clipping system
- Kit for 1 3/4" and 2 1/4" thick doors
- US-cylinder above handle



ALLEGRO Zamac Trim Kits

Description	PU	Part Number
Handle sets for active doors with US-cylinder	1	K-U5192-Z1-0-*
Handle sets for semi-active doors	1	K-U5146-Z0-0-*
Handle sets for fixed doors	1	K-U5110-Z0-0-*

* = Color PU = Packaging Unit

01 = Satin Chrome, 5 = Dark Bronze PC, 6 = Black PC, 7 = White PC, 28 = Pewter

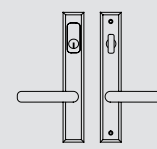
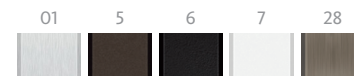

K-U5192-Z1-0-*

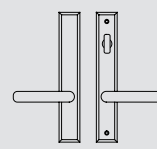

K-U5146-Z0-0-*

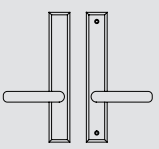

K-U5110-Z0-0-*

Additional information

- Unassembled zamac trim kits
- US-cylinder with standard 5 pins Schlage "C" keyway
- 90° locking with thumb-turn
- Self-centering 8mm spindle

- Stainless steel set screw on levers to secure spindle
- Patented handle clipping system
- Kit for 1 3/4" and 2 1/4" thick doors
- US-cylinder above handle

TORINO Handles & 30mm Plates

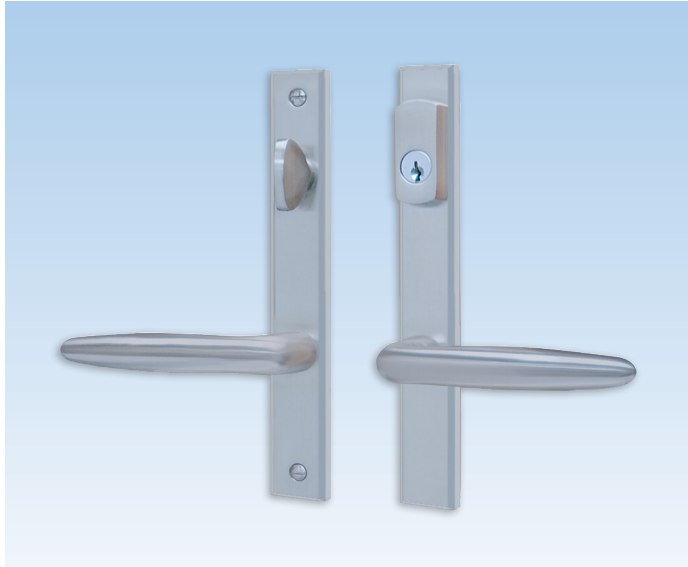

TORINO Solid brass Trim Kits

Description	PU	Part Number
Handle sets for active doors with US-cylinder	1	K-U3492-01-0-*
Handle sets for semi-active doors	1	K-U3446-00-0-*
Handle sets for fixed doors	1	K-U3410-00-0-*

* = Color PU = Packaging Unit
 01 = Satin Chrome, 03 = Polished Brass, 04 = Antique Brass,
 05 = Oil Rubbed Bronze, 11 = Satin Nickel, 25 = Dark Bronze, 28 = Pewter

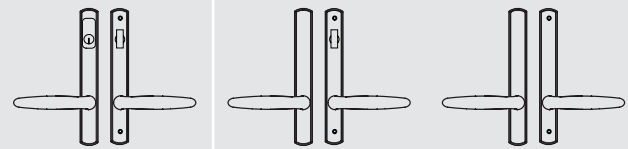
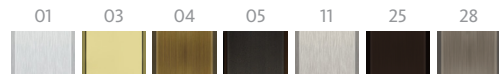

K-U3492-01-0-*

K-U3446-00-0-*

K-U3410-00-0-*

Additional information

- Unassembled solid brass trim kits
- US-cylinder with standard 5 pins Schlage "C" keyway
- 90° locking with thumb-turn
- Self-centering 8mm spindle

- Stainless steel set screw on levers to secure spindle
- Patented handle clipping system
- Kit for 1 3/4" and 2 1/4" thick doors
- US-cylinder above handle



TORINO Zamac Trim Kits

Description	PU	Part Number
Handle sets for active doors with US-cylinder	1	K-U5492-Z1-0-*
Handle sets for semi-active doors	1	K-U5446-Z0-0-*
Handle sets for fixed doors	1	K-U5410-Z0-0-*

* = Color PU = Packaging Unit
 01 = Satin Chrome, 5 = Dark Bronze PC, 6 = Black PC, 7 = White PC, 28 = Pewter

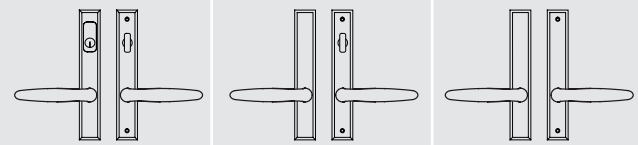
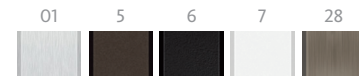

K-U5492-Z1-0-*

K-U5446-Z0-0-*

K-U5410-Z0-0-*

Additional information

- Unassembled zamac trim kits
- US-cylinder with standard 5 pins Schlage "C" keyway
- 90° locking with thumb-turn
- Self-centering 8mm spindle

- Stainless steel set screw on levers to secure spindle
- Patented handle clipping system
- Kit for 1 3/4" and 2 1/4" thick doors
- US-cylinder above handle

VENICE Handle & 30mm Plate



VENICE Solid Brass Trim Kits

Description	PU	Part Number
Handle sets for active doors with US-cylinder	1	K-U3692-01-0-*
Handle sets for semi-active doors	1	K-U3646-00-0-*
Handle sets for fixed doors	1	K-U3610-00-0-*

* = Color PU = Packaging Unit

01 = Satin Chrome, 03 = Polished Brass, 04 = Antique Brass, 05 = Oil Rubbed Bronze, 11 = Satin Nickel, 25 = Dark Bronze, 28 = Pewter

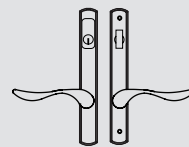
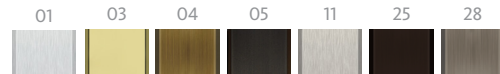

K-U3692-01-0-*

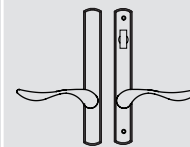

K-U3646-00-0-*

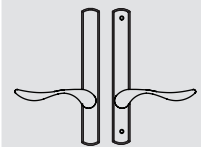

K-U3610-00-0-*

Additional information

- Unassembled solid brass trim kits
- US-cylinder with standard 5 pins Schlage "C" keyway
- 90° locking with thumb-turn
- Self-centering 8mm spindle

- Stainless steel set screw on levers to secure spindle
- Patented handle clipping system
- Kit for 1 3/4" and 2 1/4" thick doors
- US-cylinder above handle



VENICE Zamac Trim Kits

Description	PU	Part Number
Handle sets for active doors with US-cylinder	1	K-U5692-Z1-0-*
Handle sets for semi-active doors	1	K-U5646-Z0-0-*
Handle sets for fixed doors	1	K-U5610-Z0-0-*

* = Color PU = Packaging Unit

01 = Satin Chrome, 5 = Dark Bronze PC, 6 = Black PC, 7 = White PC, 28 = Pewter

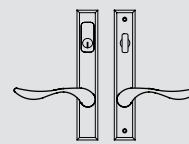
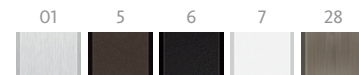

K-U5692-Z1-0-*

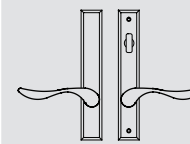

K-U5646-Z0-0-*

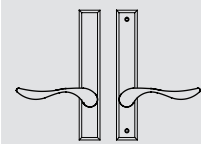

K-U5610-Z0-0-*

Additional information

- Unassembled zamac trim kits
- US-cylinder with standard 5 pins Schlage "C" keyway
- 90° locking with thumb-turn
- Self-centering 8mm spindle

- Stainless steel set screw on levers to secure spindle
- Patented handle clipping system
- Kit for 1 3/4" and 2 1/4" thick doors
- US-cylinder above handle



CAPRI Solid Brass Trim Kits

Description	PU	Part Number
Handle sets for active doors with US-cylinder	1	K-U6292-01-0-*
Handle sets for semi-active doors	1	K-U6246-00-0-*
Handle sets for fixed doors	1	K-U6210-00-0-*

* = Color PU = Packaging Unit

01 = Satin Chrome, 03 = Polished Brass, 04 = Antique Brass,
05 = Oil Rubbed Bronze, 11 = Satin Nickel, 25 = Dark Bronze, 28 = Pewter

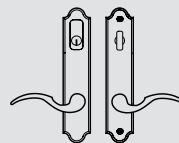
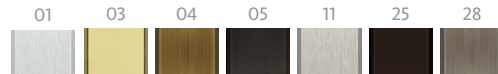

K-U6292-01-0-*

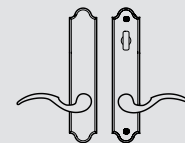

K-U6246-00-0-*

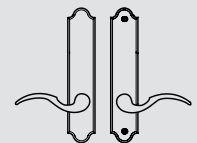

K-U6210-00-0-*

Additional information

- Unassembled solid brass trim kits
- US-cylinder with standard 5 pins Schlage "C" keyway
- 90° locking with thumb-turn
- Self-centering 8mm spindle

- Stainless steel set screw on levers to secure spindle
- Patented handle clipping system
- Kit for 1 3/4" and 2 1/4" thick doors
- US-cylinder above handle

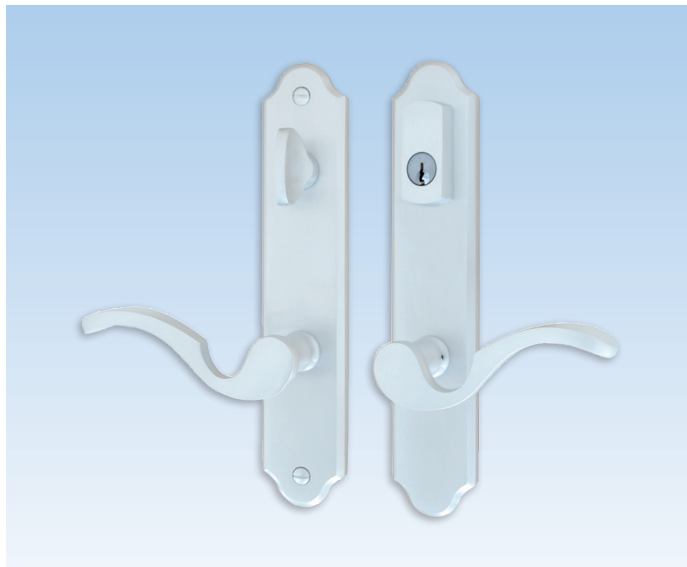

CAPRI Zamac Trim Kits

Description	PU	Part Number
Handle sets for active doors with US-cylinder	1	K-U7292-Z1-0-*
Handle sets for semi-active doors	1	K-U7246-Z0-0-*
Handle sets for fixed doors	1	K-U7210-Z0-0-*

* = Color PU = Packaging Unit

5 = Dark Bronze PC, 6 = Black PC, 7 = White PC

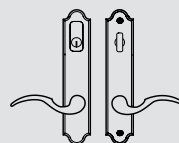
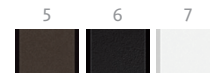

K-U7292-Z1-0-*

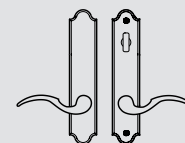

K-U7246-Z0-0-*

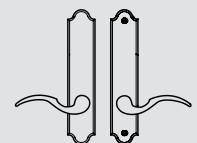

K-U7210-Z0-0-*

Additional information

- Unassembled zamac trim kits
- US-cylinder with standard 5 pins Schlage "C" keyway
- 90° locking with thumb-turn
- Self-centering 8mm spindle

- Stainless steel set screw on levers to secure spindle
- Patented handle clipping system
- Kit for 1 3/4" and 2 1/4" thick doors
- US-cylinder above handle

TORINO Handles & 45mm Plates



TORINO Solid Brass Trim Kits

Description	PU	Part Number
Handle sets for active doors with US-cylinder	1	K-U6492-01-0-*
Handle sets for semi-active doors	1	K-U6446-00-0-*
Handle sets for fixed doors	1	K-U6410-00-0-*

* = Color PU = Packaging Unit

01 = Satin Chrome, 03 = Polished Brass, 04 = Antique Brass, 05 = Oil Rubbed Bronze, 11 = Satin Nickel, 25 = Dark Bronze, 28 = Pewter

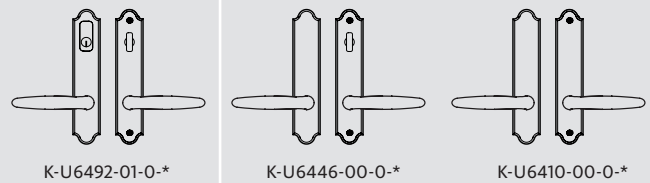
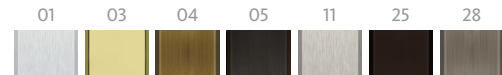

Additional information

- Unassembled solid brass trim kits
- US-cylinder with standard 5 pins Schlage "C" keyway
- 90° locking with thumb-turn
- Self-centering 8mm spindle

- Stainless steel set screw on levers to secure spindle
- Patented handle clipping system
- Kit for 1 3/4" and 2 1/4" thick doors
- US-cylinder above handle



TORINO Zamac Trim Kits

Description	PU	Part Number
Handle sets for active doors with US-cylinder	1	K-U7492-Z1-0-*
Handle sets for semi-active doors	1	K-U7446-Z0-0-*
Handle sets for fixed doors	1	K-U7410-Z0-0-*

* = Color PU = Packaging Unit

01 = Satin Chrome, 5 = Dark Bronze, 6 = Black, 7 = White, 28 = Pewter

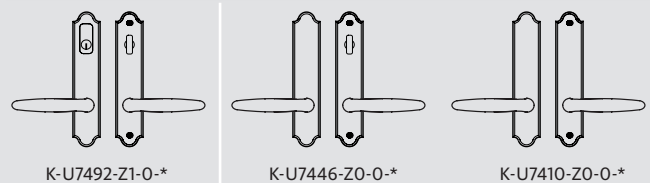
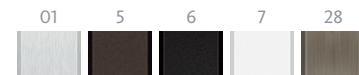

Additional information

- Unassembled zamac trim kits
- US-cylinder with standard 5 pins Schlage "C" keyway
- 90° locking with thumb-turn
- Self-centering 8mm spindle

- Stainless steel set screw on levers to secure spindle
- Patented handle clipping system
- Kit for 1 3/4" and 2 1/4" thick doors
- US-cylinder above handle



VENICE Solid Brass Trim Kits

Description	PU	Part Number
Handle sets for active doors with US-cylinder	1	K-U6692-01-0-*
Handle sets for semi-active doors	1	K-U6646-00-0-*
Handle sets for fixed doors	1	K-U6610-00-0-*

* = Color PU = Packaging Unit

01 = Satin Chrome, 03 = Polished Brass, 04 = Antique Brass,
05 = Oil Rubbed Bronze, 11 = Satin Nickel, 25 = Dark Bronze, 28 = Pewter

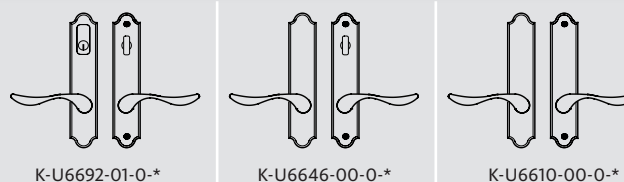
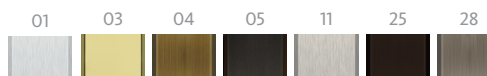

Additional information

- Unassembled solid brass trim kits
- US-cylinder with standard 5 pins Schlage "C" keyway
- 90° locking with thumb-turn
- Self-centering 8mm spindle

- Stainless steel set screw on levers to secure spindle
- Patented handle clipping system
- Kit for 1 3/4" and 2 1/4" thick doors
- US-cylinder above handle



VENICE Zamac Trim Kits

Description	PU	Part Number
Handle sets for active doors with US-cylinder	1	K-U7692-Z1-0-*
Handle sets for semi-active doors	1	K-U7646-Z0-0-*
Handle sets for fixed doors	1	K-U7610-Z0-0-*

* = Color PU = Packaging Unit

01 = Satin Chrome, 5 = Dark Bronze PC, 6 = Black PC, 7 = White PC, 28 = Pewter

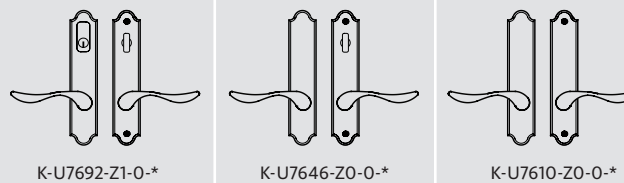
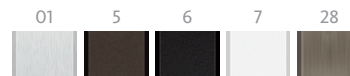

Additional information

- Unassembled zamac trim kits
- US-cylinder with standard 5 pins Schlage "C" keyway
- 90° locking with thumb-turn
- Self-centering 8mm spindle

- Stainless steel set screw on levers to secure spindle
- Patented handle clipping system
- Kit for 1 3/4" and 2 1/4" thick doors
- US-cylinder above handle

ROMA Handle & 55mm Plates



ROMA Solid Brass Trim Kits

Description	PU	Part Number
Handle sets for active doors with US-cylinder	1	K-U4092-01-0-*
Handle sets for semi-active doors	1	K-U4046-00-0-*
Handle sets for fixed doors	1	K-U4010-00-0-*
Handle sets for Danalock smart lock	1	K-U4092-D0-0-*
Handle sets for Tedee smart lock	1	K-U4092-T1-0-*

* = Color PU = Packaging Unit

11 = Satin Nickel, 25 = Dark Bronze, 28 = Pewter

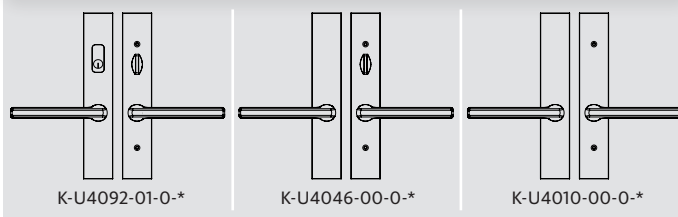
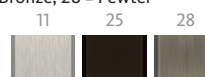

Additional information

- Unassembled solid brass trim kits
- US-cylinder with standard 5 pins Schlage "C" keyway
- 90° locking with thumb-turn
- Self-centering 8mm spindle

- Stainless steel set screw on levers to secure spindle
- Patented handle clipping system
- Kit for 1 3/4" and 2 1/4" thick doors
- US-cylinder above handle
- Compatible with Danalock V3 and Tedee smart locks



ROMA Zamac Trim Kits

Description	PU	Part Number
Handle sets for active doors with US-cylinder	1	K-U9092-Z1-0-*
Handle sets for semi-active doors	1	K-U9046-Z0-0-*
Handle sets for fixed doors	1	K-U9010-Z0-0-*
Handle sets for Danalock smart lock	1	K-U9092-D0-0-*
Handle sets for Tedee smart lock	1	K-U9092-T1-0-*

* = Color PU = Packaging Unit

6 = Black PC

6

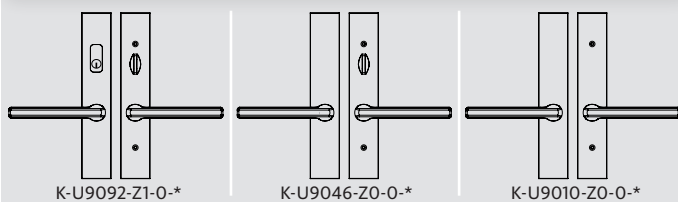

Additional information

- Unassembled zamac trim kits
- US-cylinder with standard 5 pins Schlage "C" keyway
- 90° locking with thumb-turn
- Self-centering 8mm spindle

- Stainless steel set screw on levers to secure spindle
- Patented handle clipping system
- Kit for 1 3/4" and 2 1/4" thick doors
- US-cylinder above handle
- Compatible with Danalock V3 and Tedee smart locks



BERLIN Solid Brass Trim Kits

Description	PU	Part Number
Handle sets for active doors with US-cylinder	1	K-U2592-01-0-*
Handle sets for semi-active doors	1	K-U2546-00-0-*
Handle sets for fixed doors	1	K-U2510-00-0-*
Handle sets for Danalock smart lock	1	K-U2592-D0-0-*
Handle sets for Tedee smart lock	1	K-U2592-T1-0-*

* = Color PU = Packaging Unit

11 = Satin Nickel, 28 = Pewter

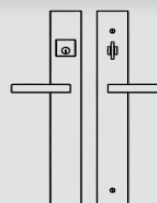
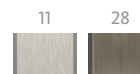

K-U2592-01-0-*

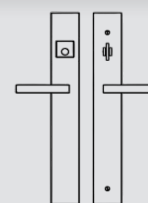

K-U2546-00-0-*

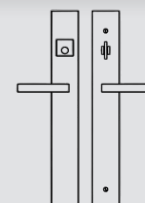

K-U2510-00-0-*

Additional information

- Unassembled Solid Brass trim kits
- US-cylinder with standard 5 pins Schlage "C" keyway
- New snapping mechanism for the 90° locking with thumb-turn
- Self-centering 8mm spindle
- Stainless steel set screw on levers to secure spindle
- Patented handle clipping system
- Kit for 1 3/4" and 2 1/4" thick doors
- US-cylinder above handle
- Compatible with Danalock V3 and Tedee smart locks

- Active trim kits are converted to Semi-Active and Dummy using a pre-assembled cylinder plug and screw-in Dummy brackets (included in the kits)



BERLIN Zamac Trim Kits

Description	PU	Part Number
Handle sets for active doors with US-cylinder	1	K-U8592-Z1-0-*
Handle sets for semi-active doors	1	K-U8546-Z0-0-*
Handle sets for fixed doors	1	K-U8510-Z0-0-*
Handle sets for Danalock smart lock	1	K-U8592-D0-0-*
Handle sets for Tedee smart lock	1	K-U8592-T1-0-*
* = Color		PU = Packaging Unit
5 = Dark Bronze PC, 6 = Black PC		
<div style="display: flex; justify-content: center; gap: 10px;"> <div style="text-align: center;">5 </div> <div style="text-align: center;">6 </div> </div>		
<div style="display: flex; justify-content: space-around;"> <div style="text-align: center;"> K-U8592-Z1-0-* </div> <div style="text-align: center;"> K-U8546-Z0-0-* </div> <div style="text-align: center;"> K-U8510-Z0-0-* </div> </div>		

Additional information

- Unassembled Zamac trim kits
- US-cylinder with standard 5 pins Schlage "C" keyway
- New snapping mechanism for the 90° locking with thumb-turn
- Self-centering 8mm spindle
- Stainless steel set screw on levers to secure spindle
- Patented handle clipping system
- Kit for 1 3/4" and 2 1/4" thick doors
- US-cylinder above handle
- Compatible with Danalock V3 and Tedee smart locks

- Active trim kits are converted to Semi-Active and Dummy using a pre-assembled cylinder plug and screw-in Dummy brackets (included in the kits)



Smart lock

Description	PU	Part Number
Danalock V3 Z-Wave	1	K-C0380-00-0-1
Danalock V3 Bluetooth	1	K-C0380-01-0-*
* = Color		PU = Packaging Unit
1 = Silver, 6 = Black		



Additional information

- 4 X CR123A batteries (included)
- Bluetooth 4.2 (Danalock app)
- Z-Wave (Automation hub - only available in Silver finish)
- 256bit AES encryption level
- No cut-out modification required (retro-fit)
- Compatible with 55, 65 mm plates and US rosette



Bluetooth keypad

Description	PU	Part Number
Danapad V3	1	6-C9407-00-0-*
* = Color		PU = Packaging Unit
1 = Silver, 6 = Black		



Additional information

- 4 X AAA batteries (included)
- Bluetooth 4.2
- 256bit AES encryption level
- Compatible with smart lock (Danalock V3) and Universal Module



Danalock Remote Access

Description	PU	Part Number
Danabridge V3	1	6-C9402-00-0-0

Additional information

- 53 mm x 53 mm x 32 mm / Weighs 36 g
- USB power supply
- Add remote access to smart locks (Danalock or Universal Module)
- 2 Smart locks can be controlled with one Danabridge (via Bluetooth 4.2)
- Communication with Wi-Fi 802.11b/g/n



Danalock Accessories

Description	PU	Part Number
Danalock black inner ring	1	9-C0553-00-0-6

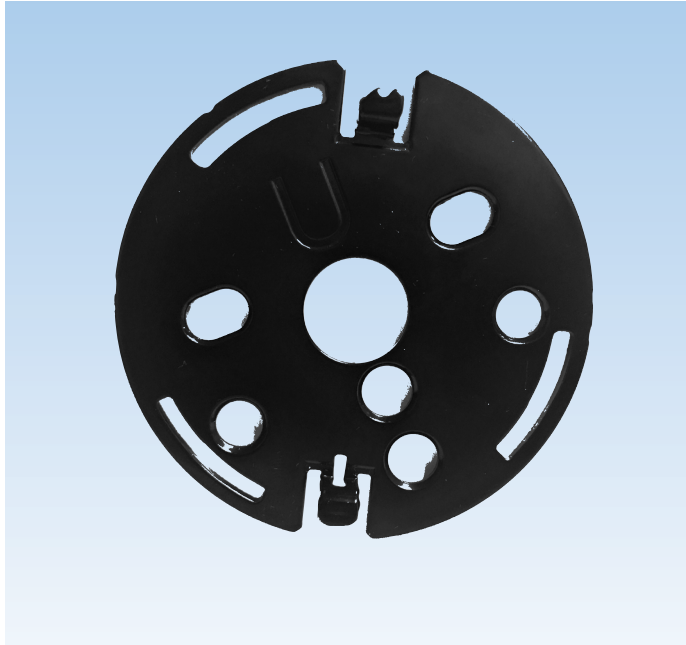

Danalock Accessories

Description	PU	Part Number
U Bracket	1	9-C0552-00-0-6

Additional information

- Replacement part for K-C0380-00-0-*



Danalock Accessories

Description	PU	Part Number
M4 button hex screws	4	9-C0967-04-0-8

Additional information

- Replacement part for K-C0380-00-0-*



Danalock Accessories

Description	PU	Part Number
Green Insert	1	9-C0558-00-0-0

Additional information

- Replacement part for K-C0380-00-0-*

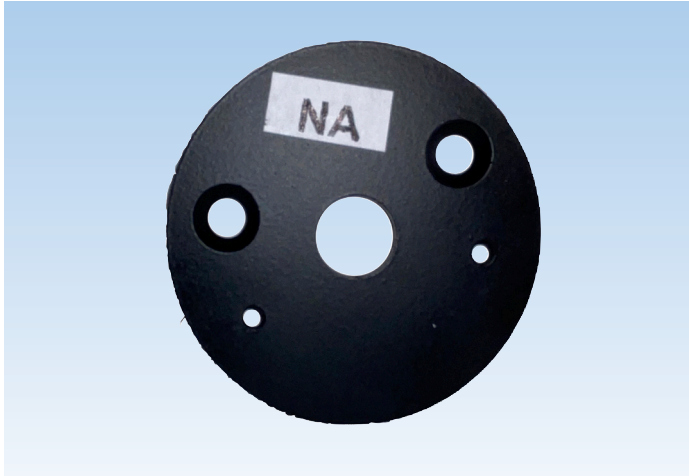

Danalock Accessories

Description	PU	Part Number
Black spacer NA	1	9-C0545-00-0-6

Additional information

- Replacement part for K-C0380-XX-0-*

Smart locks

for Door Lock

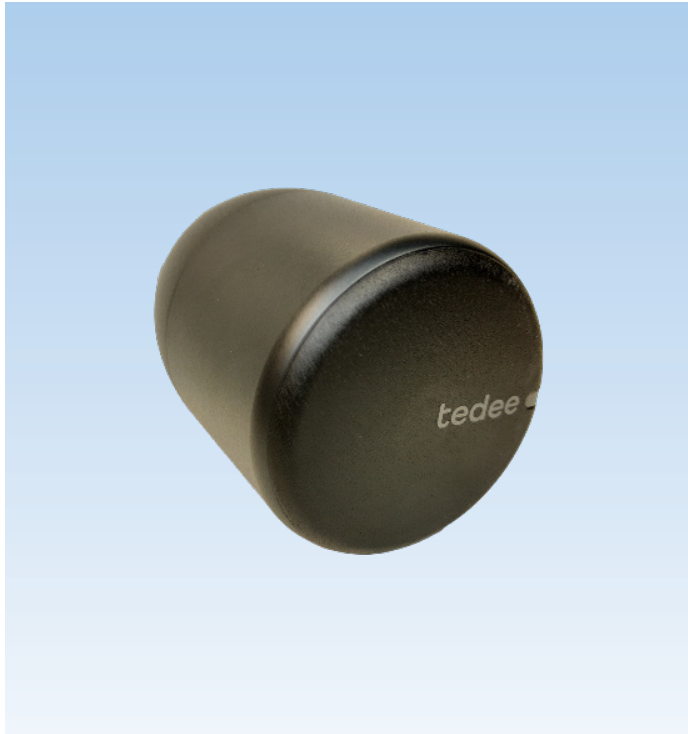

Smart lock

Description	PU	Part Number
Tedee PRO Smart Lock	1	6-C9370-00-0-*
PU = Packaging Unit		
1 = Silver, 6 = Black		



Additional information

- Rechargeable 3000 mAh LiPo battery (included)
- Bluetooth BLE 5.0 2,4 GHz (Tedee app) and Internet connection
- Security TLS 1.3
- Compatible with 55,65 mm plates and US rosettes

03
4



Tedee Smart lock remote access (Wi-Fi)

Description	PU	Part Number
Tedee Smart Bridge	1	6-C9382-00-0-7
PU = Packaging Unit		

Additional information

- Dimensions 63.5 x 63.5 x 28 mm / Weight 51.6g
- Power connection socket plug (included) or micro-USB (cable not included)
- Wi-Fi 2.4 GHz and 5.0 GHz
- Bluetooth 5.0 2.4 GHz
- Security TLS 1.3
- Compatible with Tedee smart lock 6-C9370-00-0-X and Bluetooth Keypad 6-C9387-00-0-6
- Works with smart home systems

Smart locks

for Door Lock



Bluetooth keypad

Description	PU	Part Number
Tedee Keypad	1	6-C9387-00-0-6
PU = Packaging Unit		

Additional information

- 3 X AAA batteries (included)
- Bluetooth 5.0 2,4 GHz
- Security TLS 1.3
- Up to 100 unique PINS
- Backlighting buttons, Sound signal, Bell button
- IP65 protection class
- Compatible with Tedee smart lock 6-9370-00-0-X and bridge 6-C9382-00-0-7

Strike Plates

for Door Lock

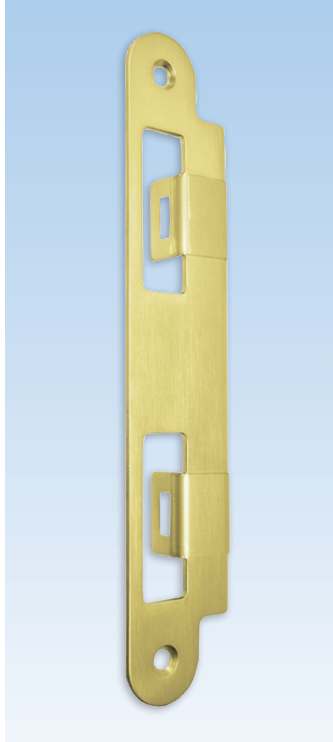

Middle Strike Plate with Extended Lip

Description	PU	Part Number
Latch and deadbolt strike plate for 45mm (1 3/4") thick doors	10	9-C4777-45-0-*
Latch and deadbolt strike plate for 57mm (2 1/4") thick doors	10	9-C4777-57-0-*
* = Color		PU = Packaging Unit
03 = Polished Brass, 04 = Antique Brass, 5 = Dark Bronze PC, 6 = Black PC, 11 = Satin Nickel, 25 = Dark Bronze, 28 = Pewter		

Additional information

- Solid brass (03, 04, 28) or stainless steel (5, 6, 11)
- Non-handed
- With clear protective film
- Available in handle matching finishes
- Two #8 x 5/8 FH/PH screws included
- For use with GU-SECURY S-Bolt active door lock (single door only)

03
4

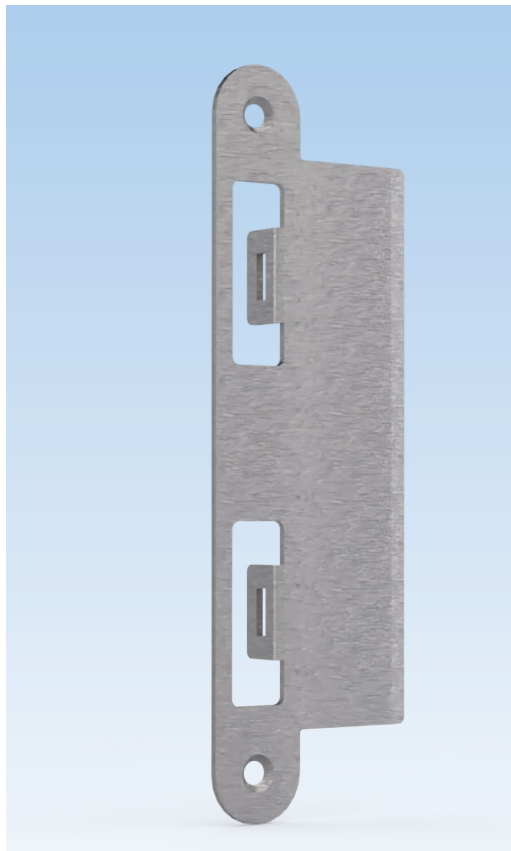

Middle Striker with Extended Lip

Description	PU	Part Number
Latch and deadbolt strike plate for 76mm (3") thick doors	10	9-C4717-59-0-*
* = Color		PU = Packaging Unit
8B = Stainless Steel, 6 = Black		

Additional information

- Made in stainless steel
- Non-handed
- Two #8 x 5/8 FH/PH screws not included
- For use with GU-SECURY S-Bolt active door lock (single door only)

Strike Plates and Blockers

for Double Doors

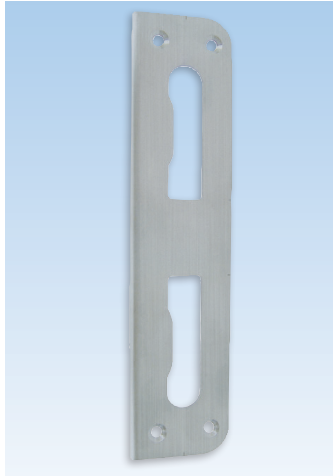

Middle Strike Plate with Extended Lip

Description	Color	PU	Part Number
Latch and deadbolt strike plate for 45mm (1 3/4") thick doors	Stainless Steel	10 100	9-C4779-45-0-11
Latch and deadbolt strike plate for 57mm (2 1/4") thick doors	Stainless Steel	10 100	9-C4779-57-0-11
PU = Packaging Unit			

Additional information

- Made of stainless steel
- Non-handed
- Used for S-Bolt door locks only
- Strike cups cannot be used
- To be used with blockers



Mounted on inactive lock

Kit of Latch and Deadbolt Blockers

Description	Color	PU	Part Number
Kit of 12mm blockers	Black	10	K-19658-12-0-6
Kit of 16mm blockers	Black	10	K-19658-16-0-6
Kit of 19mm blockers	Black	10	K-19658-19-0-6
Kit of 22mm blockers	Black	10	K-19658-22-0-6
Kit of 25mm blockers	Black	10	K-19658-25-0-6
PU = Packaging Unit			

Additional information

- Top blocker made of nylon and bottom blocker made of stainless steel
- Non-handed
- Bag contains: 10 blockers, 10 screws and 1 Allen key
- 2 pieces are required per inactive lock
- Used with S-Bolt inactive door locks 6-39570-XX-0-8B and middle strike plate 9-C4779-XX-0-11
- Length of blockers matches the thickness of astragal



Top & Bottom Strike Plate with Extended Lip

Description	Color	PU	Part Number
Strike plate for 45mm (1 3/4") thick doors	Stainless Steel	10 100	9-C4778-45-0-11
Strike plate for 57mm (2 1/4") thick doors	Stainless Steel	10 100	9-C4778-57-0-11
PU = Packaging Unit			

Additional information

- Made of stainless steel
- Non-handed
- Used for Automatic lock only
- Strike cups can be used

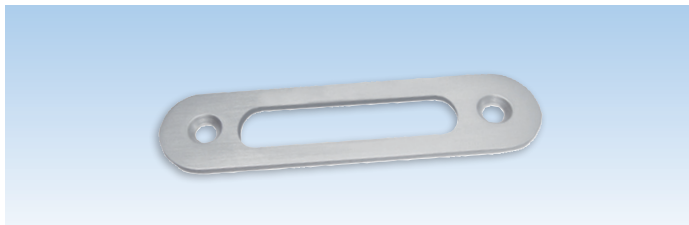
**Strike Plate**

Description	Color	PU	Part Number
Strike plate for shoot bolts	Stainless Steel	100	9-C4766-FA-0-8
PU = Packaging Unit			

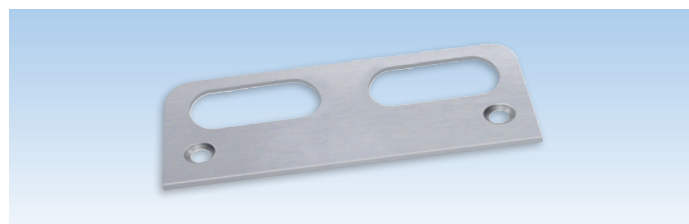
**Strike Plate**

Description	Color	PU	Part Number
Strike plate for shoot bolts	Stainless Steel	1	9-U1301-00-0-8
PU = Packaging Unit			

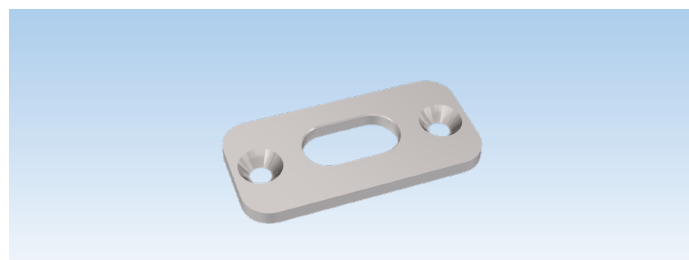
**AML keeper**

Description	Color	PU	Part Number
Keeper 52mm	Stainless Steel	1	9-C4308-00-K-8B
PU = Packaging Unit			

Strike Cups

for Shoot Bolts

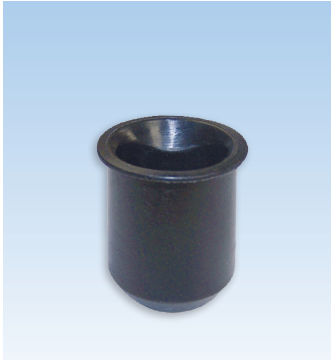

Adjustable Strike Cups 22 and 27mm

Description	Color	PU	Part Number
22mm sleeve for shoot bolts	Black	100	9-C4306-22-0-0
27mm sleeve for shoot bolts	Black	100	9-C4306-27-0-0
PU = Packaging Unit			

Additional information

- Made of reinforced nylon
- In and out adjustment of 1mm
- Allow a lateral movement of ± 2.8 mm
- Possible reach of 5mm



Strike Cups 22mm Deep

Description	Color	PU	Part Number
22mm sleeve for shoot bolts	Brass	10	9-34442-00-0-0
PU = Packaging Unit			

Additional information

- Made of Brass
- For \varnothing 10mm round shootbolts

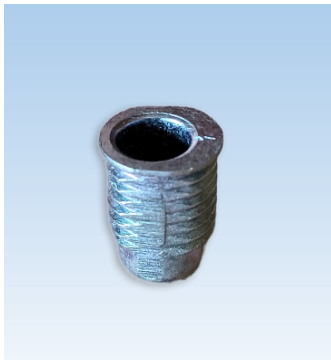

Adjustable Strike Cups 24mm Deep

Description	Color	PU	Part Number
24mm sleeve for shoot bolts	Zamac	10	9-C4302-22-0-3
PU = Packaging Unit			

Additional information

- Made of Zamac
- Allows a lateral adjustment of ± 1.5 mm
- For \varnothing 10mm round shootbolts

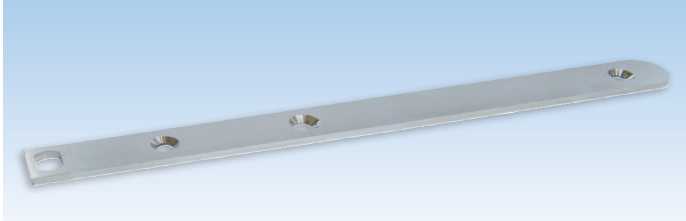

Reinforcing Strip 16mm

Description	Color	PU	Part Number
Reinforcing strip for shoot bolts	Stainless Steel	1	9-C4315-00-0-8B
PU = Packaging Unit			

Additional information

- Made of stainless steel
- Reinforced the edges of shoot bolts for higher performance
- Recommended for PVC and aluminum
- 200 mm x 16 mm

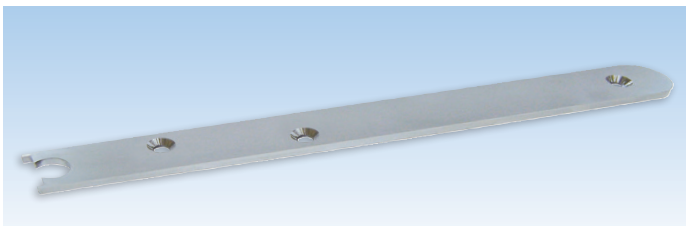

Reinforcing Strip 20mm

Description	Color	PU	Part Number
Reinforcing strip for shoot bolts	Stainless Steel	1	9-C4316-00-0-8B
PU = Packaging Unit			

Additional information

- Made of stainless steel
- Reinforced the edges of shoot bolts for higher performance
- Recommended for timber
- 200 mm x 20 mm



Fastening Screws

Description	Color	PU	Part Number
D1 screws	Stainless Steel	1000	9-C5362-32-0-8
PU = Packaging Unit			

Additional information

- Stainless steel lock fastening screws
- Type D1 with self-drilling spiral point and high duplex thread with "Quadrex" socket
- Sharp tip for quick drive



Handle Set Color Chips

Description	PU	Part Number
Color chips	1	K-C4780-00-0-0

PU = Packaging Unit

01 = Satin Chrome, 03 = Polished Brass, 04 = Antique Brass,
05 = Oil Rubbed Bronze, 5 = Dark Bronze PC, 6 = Black PC, 7 = White PC,
11 = Satin Nickel, 25 = Dark Bronze, 28 = Pewter

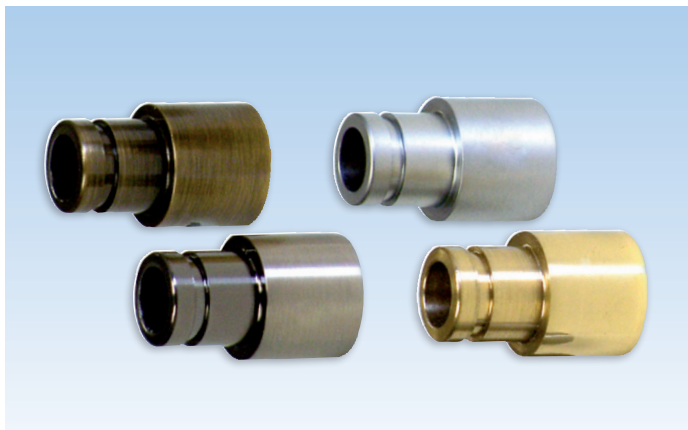

Handle Extenders

Description	PU	Part Number
Handle extenders	1	9-C0695-00-0-*

* = Color PU = Packaging Unit

01 = Satin Chrome, 03 = Polished Brass, 04 = Antique Brass, 05 = Oil Rubbed Bronze,
5 = Dark Bronze, 6 = Black, 25 = Dark Bronze, 28 = Pewter



Additional information

- Made of solid brass
- Use with our solid brass handle sets
- Extends 18mm

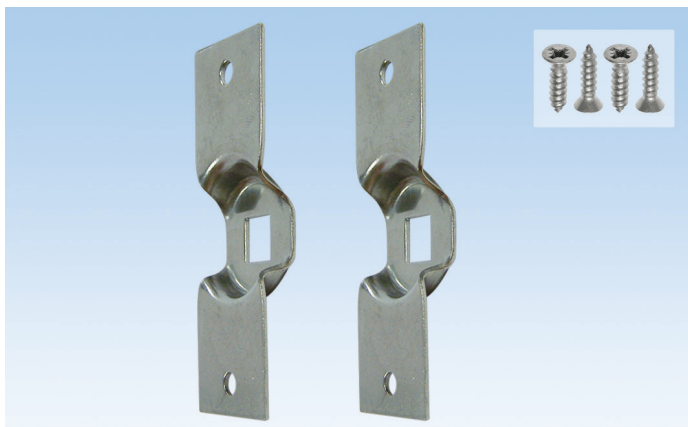

Fixing Plate for Dummy Trim Kits

Description	PU	Part Number
Fixing plate used for fixed door handle	50	9-U8210-00-0-3

PU = Packaging Unit

Additional information

- Made of zinc plated steel
- Bag of two dummy plates and four #6 x 5/8" FH/PH screws
- Included with Handle Dummy kits
- Part not required for Active & Semi-Active handles
- Fixing in the door

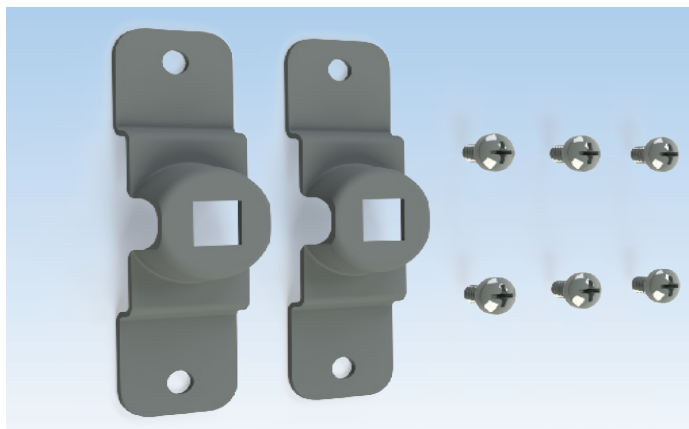

Fixing Plate for Dummy Trim Kits with 55 and 65mm plate

Description	PU	Part Number
Fixing Plate for Dummy trim kits	1	K-C0973-00-0-0
PU = Packaging Unit		

Information supplémentaire

- Made of Zinc plated steel
- Bag of two dummy plates and four #6 x 5/8" FH/PH screws
- Included with 55 and 65mm plate Handle Dummy Kits
- Part not required for active and semi-active handles
- Fixing in the plate

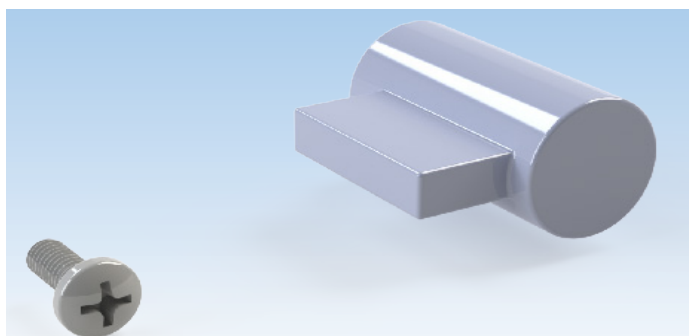

Dummy conversion kit

Description	PU	Part Number
Dummy conversion kit	1	K-C0971-00-0-*
* = Color		PU = Packaging Unit

11 = Satin Nickel, 25 = Dark Bronze

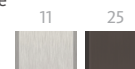

Information supplémentaire

- Made of Brass
- Bag of one dummy cylinder and one M4 x 10mm FH/PH screws
- Pre-installed with dummy and semi-active handles with 65mm plate
- Part not required for active handles

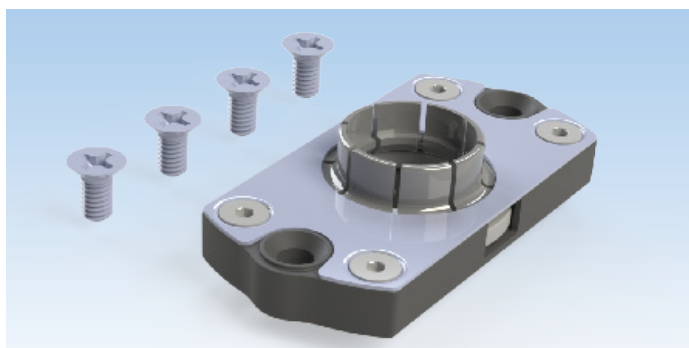

Replacement Snap & Turn box

Description	PU	Part Number
Snap & Turn Box	1	K-C2057-00-0-0
PU = Packaging Unit		

Information supplémentaire

- Bag of one box and four M4 x 8mm FH/PH screws
- Included with handle sets with 65mm plate

Accessories

for Lever Handle

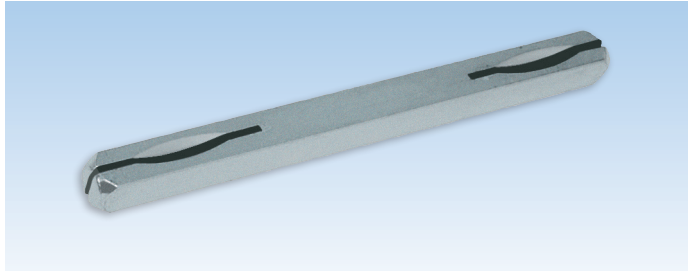

8mm Spindle

Description		PU	Part Number
8 x 8 x 120mm spindle for 41-57mm thick doors <i>(1 spindle is supplied with door handle kit)</i>	Zinc	10	9-U8100-20-0-8
8 x 8 x 130mm spindle for 57-76mm thick doors	Zinc	10	9-U8100-30-0-8
PU = Packaging Unit			

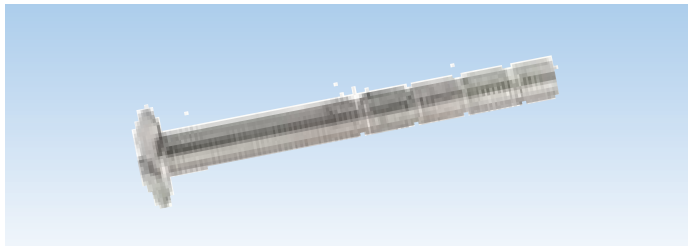

Re-cuttable M5 Screw

Description	PU	Part Number
① M5 x 90mm screws <i>(2 screws are supplied with door handle kit)</i>	1	9-U2510-90-R-*
* = Color		PU = Packaging Unit
01 = Satin Chrome, 03 = Polished Brass, 04 = Antique Brass, 05 = Oil Rubbed Bronze, 5 = Dark Bronze, 6 = Black, 7 = White, 11 = Satin Nickel, 25 = Dark Bronze, 28 = Pewter		

① For 41-76 mm thick doors



Set Screw & Allen Key

Description	Color	PU	Part Number
M5 set screw <i>(2 screws are included with door handle kit)</i>	Stainless Steel	1	9-U6008-05-0-1
Allen key 2.5 x 20 x 100mm <i>(1 Allen key is supplied with door handle kit)</i>	Black	1	9-C0955-10-0-0
PU = Packaging Unit			

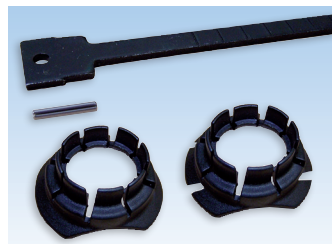

Knob Tail Replacement Kits

Description	Color	PU	Part Number
48mm knob tail with snap rings	Black	1	K-C0600-48-0-0
72mm recutable knob tail with snap rings	Black	1	K-C0600-72-0-0
PU = Packaging Unit			

Additional information

- Knob tail made of tempered steel
- Used for semi-active handle trim kits
- 48 mm for doors from 1 3/4" to 2 3/4"
- 72mm recutable for doors from 2 3/4" to 3 5/8"



- ① For 41-57 mm thick doors with plate 30,45,55mm
- ② For 41-57 mm thick doors with plate 65mm
- ③ For 41-76 mm thick doors

Snap Rings

Description	Color	PU	Part Number
Snap ring	Black	1	9-C0645-02-0-6
Snap ring – low profile	Black	1	9-C0645-03-0-6

PU = Packaging Unit

Washers

Description	Color	PU	Part Number
Nylatron washer 0.25mm x 16mm (inner dia.)	Clear	1	9-C0647-25-0-0
Nylatron washer 0.5mm x 16mm (inner dia.)	Clear	1	9-C0647-50-0-0
Nylatron washer 1.0mm x 16mm (inner dia.)	Clear	1	9-C0647-10-0-0

PU = Packaging Unit

“O” Ring

Description	Color	PU	Part Number
“O” ring 1.5mm x 16mm (inner dia.)	Black	1	9-C0953-00-0-6

PU = Packaging Unit

Cylinders Schlage “C” Keyway

Description	Color	PU	Part Number
① Cylinder with 52mm tail and set of three keys	Zinc	1	6-C0971-52-0-1
	Brass	1	6-C0971-52-0-3
	Dark Bronze	1	6-C0971-52-0-25
② Cylinder with 64mm tail and set of three keys	Zinc	1	6-C0971-64-0-1
	Dark Bronze	1	6-C0971-64-0-25
③ Cylinder with 90 mm tail and set of three keys	Zinc	1	6-C0971-90-0-1
	Brass	1	6-C0971-90-0-3
	Dark Bronze	1	6-C0971-90-0-25

PU = Packaging Unit

Key Alike Cylinders Schlage “C” Keyway

Description	Color	PU	Part Number
① Cylinder with 52mm tail and set of three keys	Zinc	1	6-C0971-52-9-1
	Brass	1	6-C0971-52-9-3
	Dark Bronze	1	6-C0971-52-9-25
② Cylinder with 64mm tail and set of three keys	Zinc	1	6-C0971-64-0-1
	Dark Bronze	1	6-C0971-64-0-25
③ Cylinder with 90mm tail and set of three keys	Zinc	1	6-C0971-90-9-1
	Brass	1	6-C0971-90-9-3
	Dark Bronze	1	6-C0971-90-9-25

PU = Packaging Unit

Accessories

for Lever Handle

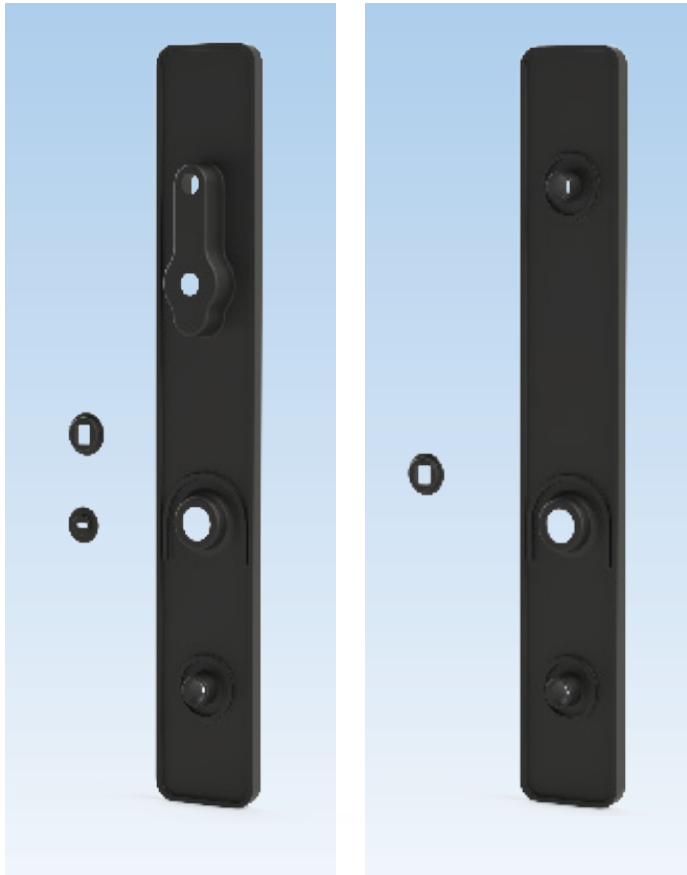

Gasket 55mm

Description	Color	PU	Part Number
Gasket for active plate	Black	1	6-C0825-55-0-6
Gasket for inactive plate	Black	1	6-C0826-55-0-6
* = Color		PU = Packaging Unit	

Additional information

- Not compatible with Dummy Handle fixing Plates K-C0973-00-0-0. To use this product in a dummy handle configuration, use fixing plates 6-C0800-03-0-0

Accessories

for Lever Handle

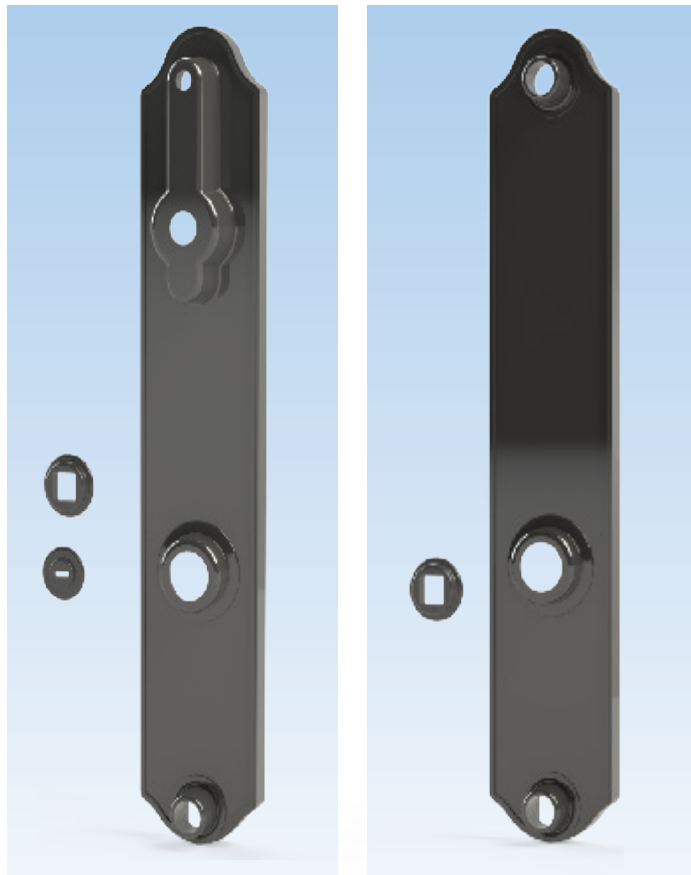

Gasket 45mm

Description	Color	PU	Part Number
Gasket for active plate	Black	1	6-C0825-00-0-6
Gasket for inactive plate	Black	1	6-C0826-00-0-6
* = Color		PU = Packaging Unit	

Accessories for Strike Plate



Dust Cup with Edge- 25mm

Description	Color	PU	Part Number
Plastic cup	Black	10	9-C4765-00-0-6
		100	9-C4765-1C-0-6
		500	9-C4765-5C-0-6
PU = Packaging Unit			

Additional information

- Use for latch and 2 automatic latches (optional)
- Dimensions:
 - Length: 62mm
 - Width: 19.5mm
 - Depth: 25.8mm



Dust Cup without Edge - 15mm

Description	Color	PU	Part Number
Plastic cup	Black	10	9-C4765-0A-0-6
		100	9-C4765-1C-A-6
		500	9-C4765-5C-A-6
PU = Packaging Unit			

Additional information

- Dimensions:
 - Length: 62mm
 - Width: 19.5mm
 - Depth: 16mm



Screws for Strike Plates

Description	PU	Part Number														
#8 x 5/8" (16mm) screws	10	K-C4763-16-6-*														
* = Color		PU = Packaging Unit														
03 = Polished Brass, 04 = Antique Brass, 5 = Dark Bronze PC, 6 = Black PC, 11 = Satin Nickel, 25 = Dark Bronze, 28 = Pewter																
<table style="display: inline-table; border: none;"> <tr> <td style="text-align: center;">03</td> <td style="text-align: center;">04</td> <td style="text-align: center;">5</td> <td style="text-align: center;">6</td> <td style="text-align: center;">11</td> <td style="text-align: center;">25</td> <td style="text-align: center;">28</td> </tr> <tr> <td style="text-align: center;"></td> <td style="text-align: center;"></td> <td style="text-align: center;"></td> <td style="text-align: center;"></td> <td style="text-align: center;"></td> <td style="text-align: center;"></td> <td style="text-align: center;"></td> </tr> </table>			03	04	5	6	11	25	28							
03	04	5	6	11	25	28										

Additional information

- Bag of 6 screws for strike plates
- #8 x 5/8" FH/PH screws

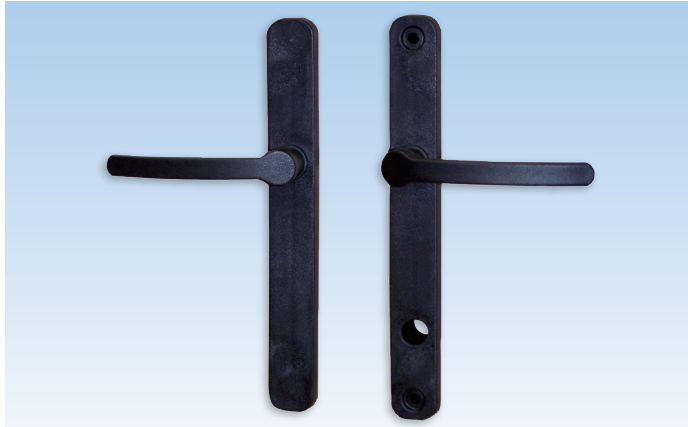

Construction Handle Set

Description	Color	PU	Part Number
Construction handle	Black	25	K-C9250-25-0-6
PU = Packaging Unit			

Additional information

- Reinforced nylon temporary door trim sets
- 8 x 8 x 90mm square spindle included
- 4.2 x 50mm screws included
- For 1 3/4" thick doors
- Locking/Unlocking from inside only



Construction Key

Description	Color	PU	Part Number
Construction key	Black	10	9-U0001-01-0-0
PU = Packaging Unit			

Additional information

The construction key is available for those who prefer to install the decorative hardware trim and lever sets on doors after the construction has been completed. Installing the escutcheon plates and levers in the final stage of construction prevents the decorative trim from becoming scratched or damaged.

The construction key has been designed to accommodate multipoint door hardware (8mm square), tilt-turn hardware (7mm square) and lift-slide hardware (10mm square).

Wood Mount Display

for Lever Handle



Wood Mount Display with Lever Handles

Description	PU	Part Number
Wood mount display	1	6-C9618-00-0-0

PU = Packaging Unit

01 = Satin Chrome, 03 = Polished Brass, 04 = Antique Brass,
 05 = Oil Rubbed Bronze, 5 = Dark Bronze PC, 6 = Black PC, 7 = White PC,
 11 = Satin Nickel, 25 = Dark Bronze, 28 = Pewter



Additional information

- To be used with 30 and 45mm estucheons and Capri, Torino, Allegro or Venice handles



Wood Mount Display for Lever Handles

Description	PU	Part Number
Wood mount display	1	6-C9613-00-0-0

* = Color

PU = Packaging Unit

Additional information

- To be used with 30 and 45mm estucheons and Capri, Torino, Allegro or Venice handles



Lined area for notes



WINDOW TECHNOLOGY
DOOR TECHNOLOGY
AUTOMATIC ENTRANCE SYSTEMS
BUILDING MANAGEMENT SYSTEMS

HEAD OFFICE

Ferco Architectural Hardware Inc.
2000, Berlier St.
Laval, QC H7L 4S4
Tel.: 450 973-1437
1 800 355-8810
Fax: 450 973-7661
ferco@ferco.ca

ONTARIO / WESTERN PROVINCES

Tel.: 905 282-9588
1 800 668-5310
Fax: 905 282-9915

UNITED STATES

Tel.: 1 800 927-1097
Fax: 1 888 454-0161

www.ferco.ca

Edition 05.2022 | Printed in Canada