



DOOR TECHNOLOGY – ORDER CATALOG | SECTION 03.3



SECURY Automatic Door Lock & Gripset Handle



Securing technology for you





03.3

SECURY Automatic Door Lock & Gripset Handle

SECURY Automatic Door Lock	03.3.3
Automatic Extension	03.3.4
Filler Pieces	03.3.5
Mortise Door lock	03.3.6
BERKELEY Gripset Handle	03.3.7
BERLIN Gripset Handle	03.3.8
Smart locks	03.3.10
Strike Plates	03.3.16
Accessories	03.3.19
Wood Display	03.3.27

SECURY Automatic Door Lock

for gripset handles and North American cylinder



Unlocked

Locked

USE WITH GRIPSET HANDLES ONLY

SECURY Automatic Door Lock for Gripset Handle

Description	Backset	Color	PU	Part Number
Door lock for 6' 8" doors	60mm	SS	5	6-35185-01-R-8B
Door lock for 8' doors	60mm	SS	5	6-35185-02-R-8B

PU = Packaging Unit

Simply Close the Door!

As soon as the door pulled shut, the Automatic latchbolts instantly throw 20mm and are secured to prevent them being forced back. By turning the key or the knob, the center deadbolt will engage and lock the top and bottom latchbolts to become a **3-deadbolt locking system**.

Additional information

- 3-point, one piece locking system for 6' 8" and 8' doors
- Heavy duty mortise construction
- Locking by US-cylinder with 90° turn of key or thumb-turn
- No lifting of handle to engage locking points
- Top and bottom Automatic latchbolt projection from 10 to 20mm:
 - Provides security
 - Protects the door
- 1" (25mm) draw on deadbolt with baby sitting function
- Non handed, latch easily reversible
- 8mm square spindle
- 92mm centres (spindle to cylinder)
- Handle height variable (36" recommended)
- 16mm stainless steel faceplate with radius ends for easy installation and cleaner look
- Same hardware groove detail throughout our entire door lock program (jig, router base and bits available)
- Extension with additional lock point is available for doors taller than 8'
- To be used only with FERCO gripset handle

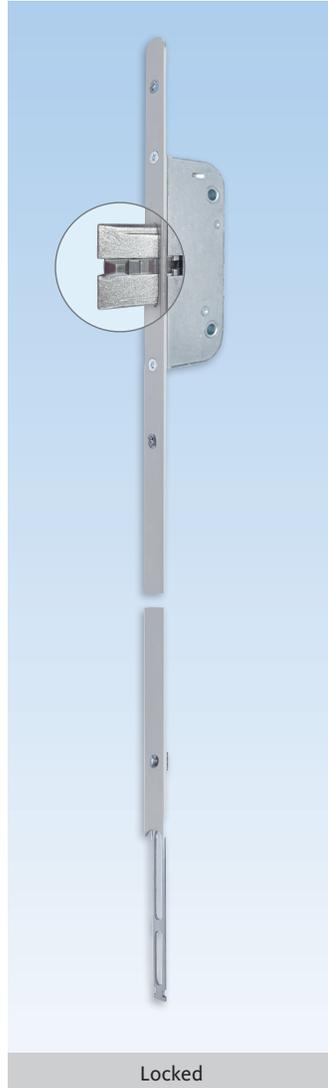
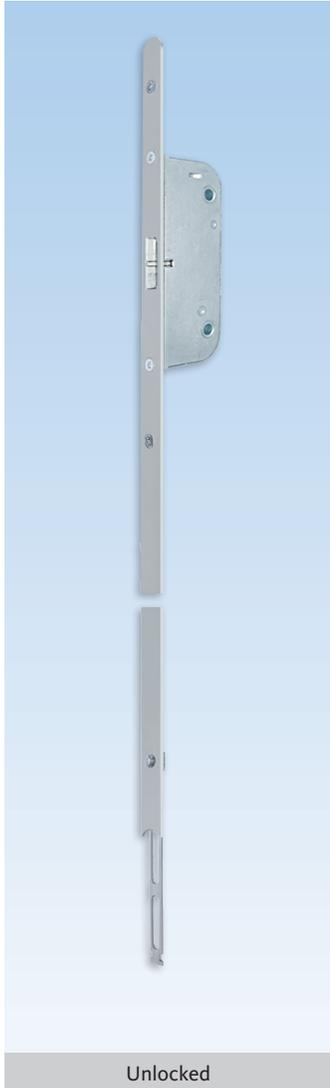

Extension with Additional Latchbolt

Description	Color	PU	Part Number
525mm extension with rounded end	Stainless Steel	5	6-33479-04-0-8B
800mm extension with rounded end	Stainless Steel	1	6-C5078-00-0-8B

* = Color PU = Packaging Unit

Additional information

- Tapered latch always engaging in strike plate
- 16mm stainless steel faceplate with radius end for easy installation and cleaner look
- Additional locking point for doors taller than 8'
- To be used with GU-SECURY Automatic door Locks

Filler pieces

Round to square

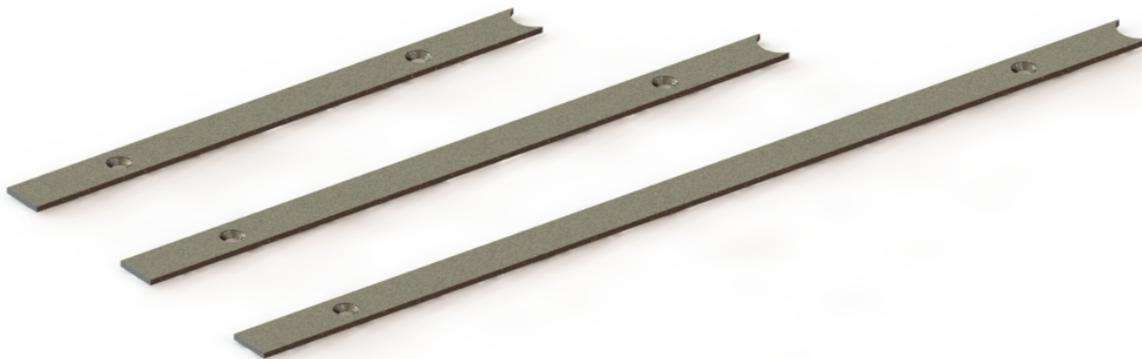

Filler Pieces

Description	PU	Part Number
Filler piece 193,7mm	1	9-C4340-19-0-8B
Filler piece 245,9mm	1	9-C4342-24-0-8B
Filler piece 342,3mm	1	9-C4342-34-0-8B

Additional information

- Made of stainless steel
- To be used with radius end locks and extensions

Formulas to select filler length:

- Bottom:
L = Handle height - 671,7mm
- Top 1590mm lock:
L = Door height - handle height - extension(s) length - 920,7mm
- Top 1900mm lock:
L = Door height - handle height - extension(s) length - 1230,7mm

03
3

Mortise Door Lock

with Latch and Deadbolt



Unlocked



Locked

Mortise Door Lock for Gripset Handle

Description	Color	PU	Part Number
Gripset Mortise door lock	Stainless Steel		6-C4888-XX-0-8B
* = Color		PU = Packaging Unit	

Additional information

- Heavy duty mortise construction with reinforced lever return spring system
- Locking by US-cylinder with 90° turn of key or thumb-turn to engage the 1" (25mm) deadbolt
- Non-handed, latch easily reversible
- 8mm square spindle
- 92mm centres (spindle to cylinder)
- 16mm stainless steel faceplate with radius ends for easy installation and cleaner look
- Same hardware groove detail throughout our entire door lock program (jig, router base and bits available)
- Ideal for exterior and interior door applications
- To be used only with FERCO gripset handle

**BERKELEY Series**

Description	PU	Part Number
Gripset active for 45mm (1 3/4") thick door (cylinder included)	1	K-C2070-00-0-*
Grip set for smart lock	1	K-C2070-D0-0-*
Grip set for smart lock	1	K-C2070-T1-0-*

* = Color PU = Packaging Unit

01 = Satin Nickel, 25 = Dark Bronze, 28 = Pewter, 6 = Black

**Additional information**

- Solid forged brass
- US-cylinder with standard Schlage "C" keyway
- 90° locking with thumb-turn
- Non-handed
- Easy to install
- Weather proof gasket
- Stainless steel set screw on interior lever to secure handle
- Easily converts to inactive handle, using dummy conversion kit K-C2056-00-0-*
- For 1 3/4" thick doors
- For 2 1/4" thick doors, use actuator conversion kit K-C2054-57-0-0
- Use with SECURY Automatic gears: 6-35185-01-R-8B and 6-35185-02-R-8B
- Compatible with Danalock V3 and Tedee smart locks
- Jig template available for handle hole cutout. See tools catalogue for details

BERLIN

Solid Brass Gripset Handle

**BERLIN Series**

Description	PU	Part Number
Gripset active for 45mm (1 3/4") thick door (cylinder included)	1	K-C2080-00-0-*
Grip set for Danalock smart lock	1	K-C2080-D0-0-*
Grip set for Tedee smart lock	1	K-C2080-T1-0-*
* = Color		PU = Packaging Unit
11 = Satin Nickel, 28 = Pewter		

**Additional information**

- Solid forged brass
- US-cylinder with standard Schlage "C" keyway
- New snapping mechanism for the 90 deg locking with thumb-turn
- Improved springload mechanism for interior lever handle
- Non-handed
- Easy to install
- Weather proof gasket
- Stainless steel set screw on interior lever to secure handle
- Easily converts to inactive handle, using dummy conversion kit K-0971-00-0-*
- For 1 3/4" thick doors
- For 2 1/4" thick doors, use actuator conversion kit K-C2054-57-0-0
- Use with SECURY Automatic gears: 6-35185-01-R-8B and 6-35185-02-R-8B
- Compatible with Danalock V3 and Tedee smart locks
- Jig template available for handle hole cutout. See tools catalogue for details

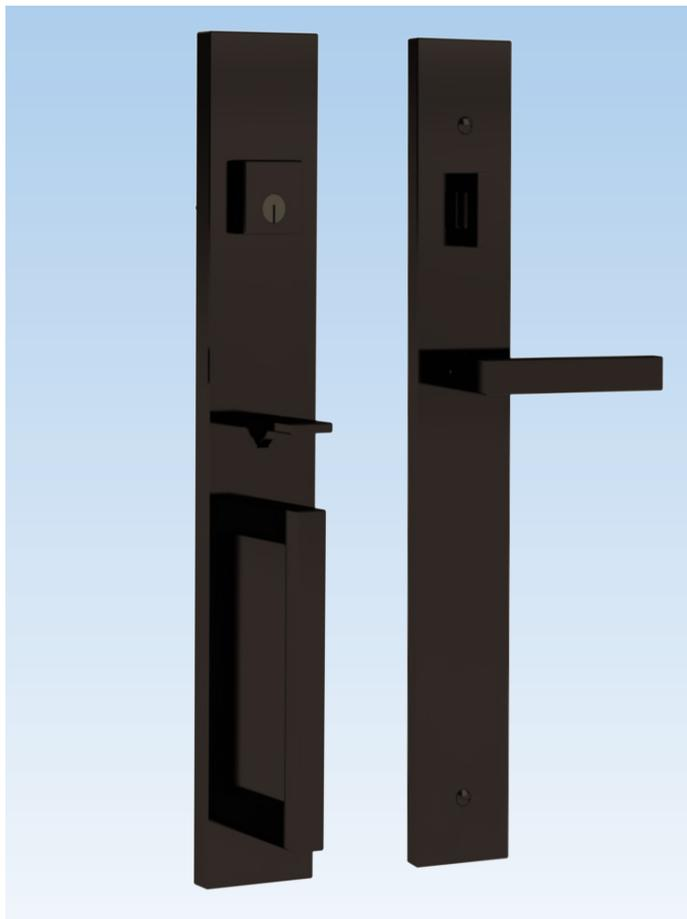
**BERLIN Series**

Description	PU	Part Number
Gripset active for 45mm (1 3/4") thick door (cylinder included)	1	K-C2080-00-0-*
Grip set for Danalock smart lock	1	K-C2080-D0-0-*
Grip set for Tedee smart lock	1	K-C2080-T1-0-*
* = Color		PU = Packaging Unit

5 = Dark Bronze, 6 = Black

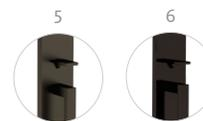
**Additional information**

- Zamac
- US-cylinder with standard Schlage "C" keyway
- New snapping mechanism for the 90 deg locking with thumb-turn
- Improved springload mechanism for interior lever handle
- Non-handed
- Easy to install
- Weather proof gasket
- Stainless steel set screw on interior lever to secure handle
- Easily converts to inactive handle, using dummy conversion kit K-C0971-00-0-*
- For 1 3/4" thick doors
- For 2 1/4" thick doors, use actuator conversion kit K-C2054-57-0-0
- Use with SECURY Automatic gears: 6-35185-01-R-8B and 6-35185-02-R-8B
- Compatible with Danalock V3 and Tedee smart locks
- Jig template available for handle hole cutout. See tools catalogue for details



Smart lock

Description	PU	Part Number
Danalock V3 Z-Wave	1	K-C0380-00-0-1
Danalock V3 Bluetooth	1	K-C0380-01-0-*
* = Color		PU = Packaging Unit
1 = Silver, 6 = Black		

6 1



Additional information

- 4 X CR123A batteries (Included)
- Bluetooth 4.2 (Danalock app)
- Z-Wave (Automation hub - only available in Silver finish)
- 256bit AES encryption level
- No cut-out modification required (retro-fit)
- Compatible with Berkeley and Berlin handles



Bluetooth keypad

Description	PU	Part Number
Danapad V3	1	6-C9407-00-0-X
* = Color		PU = Packaging Unit
1 = Silver, 6 = Black		

6 1



Additional information

- 4 X AAA batteries (included)
- Bluetooth 4.2
- 256bit AES encryption level
- Compatible with smart lock (Danalock V3) and Universal Module



Danabridge Remote Access

Description	PU	Part Number
Danabridge V3	1	6-C9402-00-0-0

Additional information

- 53 mm x 53 mm x 32 mm / Weighs 36 g
- USB power supply
- Add remote access to smart locks (Danalock or Universal Module)
- 2 Smart locks can be controlled with one Danabridge (via Bluetooth 4.2)
- Communication with Wi-Fi 802.11b/g/n



Danalock Accessories

Description	PU	Part Number
Danalock black inner ring	1	9-C0553-00-0-6

Smart locks

for Door Lock



Danalock Accessories

Description	PU	Part Number
U Bracket	1	9-C0552-00-0-6

Additional information

- Replacement part for K-C0380-00-0-*



Danalock Accessories

Description	PU	Part Number
M4 button hex screws	4	9-C0967-04-0-8

Additional information

- Replacement part for K-C0380-00-0-*



Danalock Accessories

Description	PU	Part Number
Green Insert	1	9-C0558-00-0-0

Additional information

- Replacement part for K-C0380-00-0-*

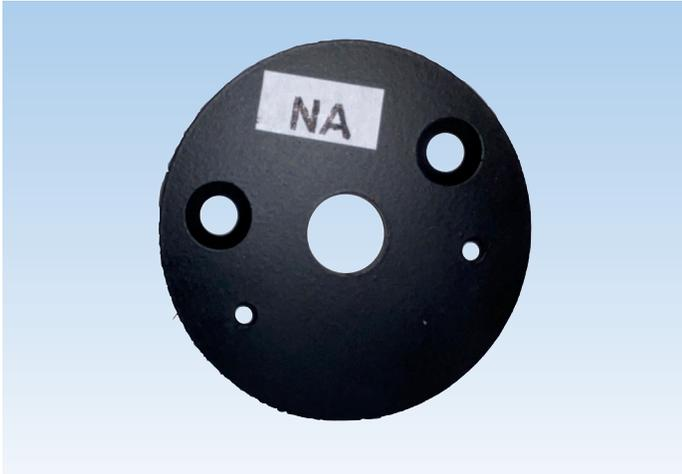

Danalock Accessories

Description	PU	Part Number
Black spacer NA	1	9-C0545-00-0-6

Additional information

- Replacement part for K-C0390-XX-0-8B

Smart locks

for Door Lock

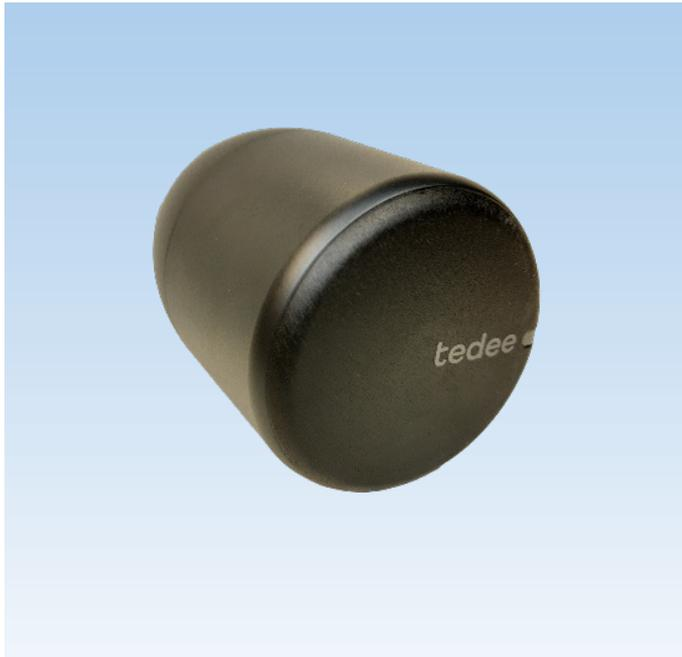

Smart lock

Description	PU	Part Number
Tedee PRO Smart Lock	1	6-C9370-00-0-*
PU = Packaging Unit		
1 = Silver, 6 = Black		



Additional information

- Rechargeable 3000 mAh LiPo battery (included)
- Bluetooth BLE 5.0 2,4 GHz (Tedee app) and Internet connection
- Security TLS 1.3
- Compatible with Berkeley and Berlin handles



Tedee Smart lock remote access (Wi-Fi)

Description	PU	Part Number
Tedee Smart Bridge	1	6-C9382-00-0-7
PU = Packaging Unit		

Additional information

- Dimensions 63.5 x 63.5 x 28 mm / Weight 51.6g
- Power connection socket plug (included) or micro-USB (cable not included)
- Wi-Fi 2.4 GHz and 5.0 GHz
- Bluetooth 5.0 2.4 GHz
- Security TLS 1.3
- Compatible with Tedee smart lock 6-C9370-00-0-X and Bluetooth Keypad 6-C9387-00-0-6
- Works with smart home systems
- Up to 5 Smart Locks can be controlled (Bluetooth Range)



Bluetooth keypad

Description	PU	Part Number
Tedee Keypad	1	6-C9387-00-0-6
PU = Packaging Unit		

Additional information

- 3 X AAA batteries (included)
- Bluetooth 5.0 2,4 GHz
- Security TLS 1.3
- Up to 100 unique PINS
- Backlighted buttons, Sound signal, Bell button
- IP65 protection class
- Compatible with Tedee smart lock 6-9370-00-0-X and bridge 6-C9382-00-0-7



Micro USB Cable

Description	PU	Part Number
Micro USB Cable for TEDEE Lock	1	6-C9377-00-0-0
PU = Packaging Unit		

Strike Plates

for Door Lock

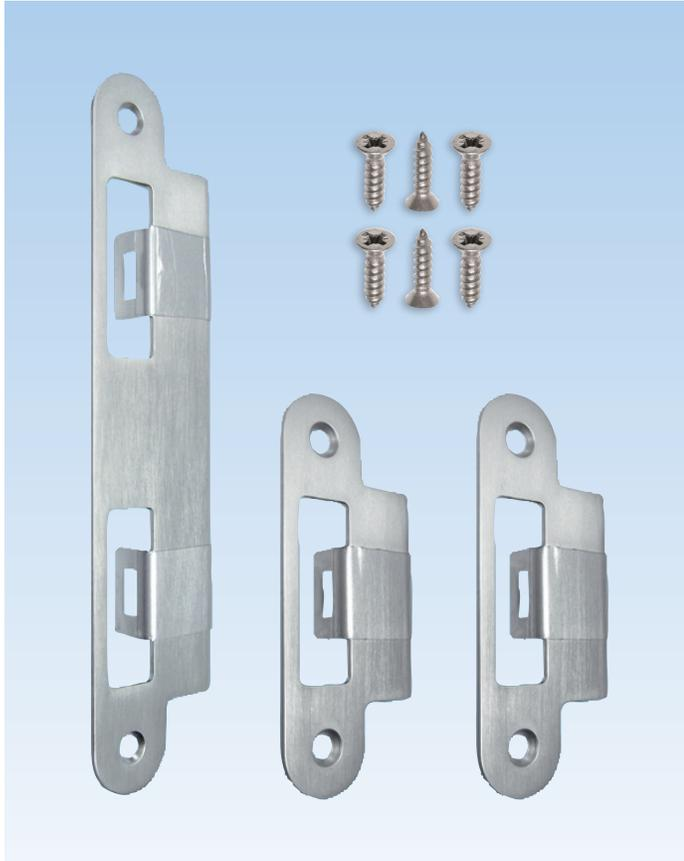

Bag of Strike Plates

Description	PU	Part Number
Bag of strike plates for 45mm (1 3/4") thick doors	50	K-C4774-45-0-*
Bag of strike plates for 57mm (2 1/4") thick doors	50	K-C4775-57-0-*

* = Color PU = Packaging Unit

11 = Satin Nickel, 5 = Dark Bronze, 28 = Pewter, 6 = Black



Additional information

- Solid brass (28) or stainless steel (5, 6, 11)
- Bag contains:
 - 1 middle striker with extended lip and clear protective film
 - 2 top and bottom strikers with extended lip and clear protective film
 - 6 screws
- Non-handed
- Available in handle matching finishes
- For use with SECURY Automatic door locks

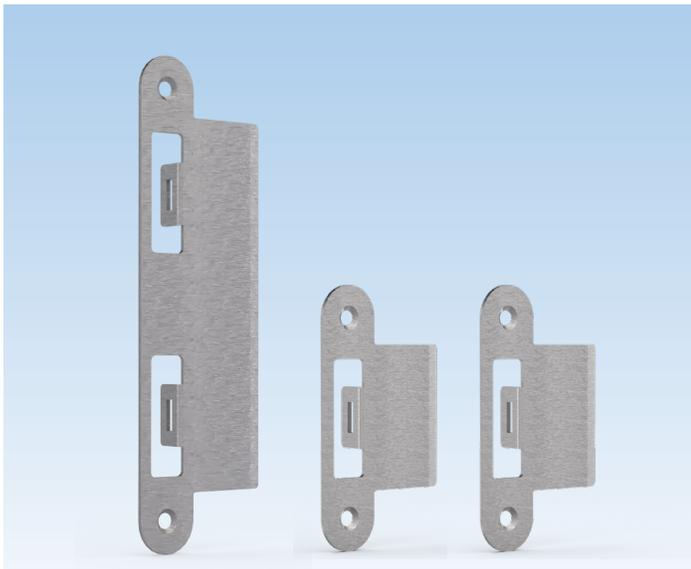

Bag of Strike Plates

Description	PU	Part Number
Bag of strike plates for 76mm (3") thick doors	1	K-C4777-59-0-*

* = Color PU = Packaging Unit

8B = Stainless Steel, 6 = Black



Additional information

- Made in stainless steel
- Bag contains:
 - 1 middle striker with extended lip
 - 2 top and bottom strikers with extended lip
- Non-handed
- For use with GU-SECURY Automatic door locks

Strike Plates

for Door Lock



Top and Bottom Striker with Extended Lip

Description	PU	Part Number
Latchbolt strike plate for 45mm (1 3/4") thick doors	10	9-C4776-45-0-*
Latchbolt strike plate for 57mm (2 1/4") thick doors	10	9-C4776-57-0-*
* = Color		PU = Packaging Unit
11 = Satin Nickel, 5 = Dark Bronze, 28 = Pewter, 6 = Black		
<div style="display: flex; justify-content: space-around; align-items: center;"> 11 5 28 6 </div> 		

Additional information

- Solid brass (28) or stainless steel (5, 6, 11)
- Non-handed
- With clear protective film
- Available in handle matching finishes
- Two #8 x 5/8 FH/PH screws included
- For use with SECURY Automatic door lock



Middle Striker with Extended Lip

Description	PU	Part Number
Latch and deadbolt strike plate for 45mm (1 3/4") thick doors	10	9-C4777-45-0-*
Latch and deadbolt strike plate for 57mm (2 1/4") thick doors	10	9-C4777-57-0-*
* = Color		PU = Packaging Unit
11 = Satin Nickel, 5 = Dark Bronze, 28 = Pewter, 6 = Black		
<div style="display: flex; justify-content: space-around; align-items: center;"> 11 5 28 6 </div> 		

Additional information

- Solid brass (28) or stainless steel (5, 6, 11)
- Non-handed
- With clear protective film
- Available in handle matching finishes
- Two #8 x 5/8 FH/PH screws included
- For use with SECURY SH2, S-Bolt, Automatic and mortise door locks

Strike Plates

for Door Lock

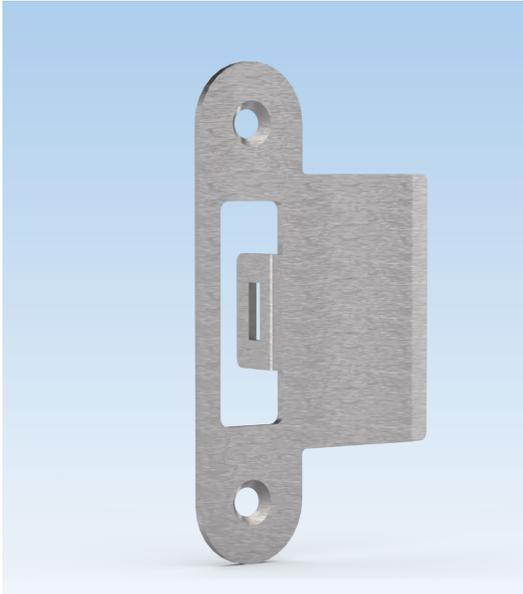

Top and Bottom Striker with Extended Lip

Description	PU	Part Number
Latchbolt strike plate for 76mm (3") thick doors	10	9-C4716-59-0-*

* = Color PU = Packaging Unit

8B = Stainless Steel, 6 = Black



Additional information

- Made in stainless steel
- Non-handed
- Two #8 x 5/8 FH/PH screws included
- For use with GU-SECURY Automatic door lock

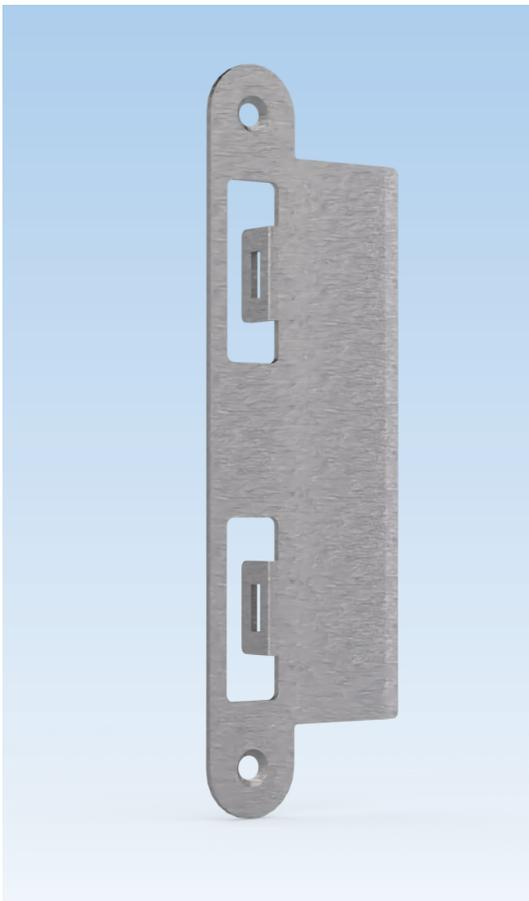

Middle Striker with Extended Lip

Description	PU	Part Number
Latch and deadbolt strike plate for 76mm (3") thick doors	10	9-C4717-59-0-*

* = Color PU = Packaging Unit

8B = Stainless Steel, 6 = Black

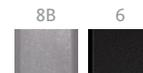

Additional information

- Made in stainless steel
- Non-handed
- Two #8 x 5/8 FH/PH screws included
- For use with GU-SECURY Automatic door lock



Torx 15 T-Key

Description	Color	PU	Part Number
Torx key	Steel	1	H-00346-15-0-0
* = Color		PU = Packaging Unit	

Additional information

- Used for connecting SH2 and Automatic extensions



4mm Allen T-Key

Description	Color	PU	Part Number
Allen key	Steel	1	H-00345-04-0-0
* = Color		PU = Packaging Unit	

Additional information

- Used for reversing Automatic latchbolts on GU-SECURY Automatic lock and extension



Fastening Screws

Description	Color	PU	Part Number
D1 screws	Stainless Steel	1000	9-C5362-32-0-8
* = Color		PU = Packaging Unit	

Additional information

- Stainless steel lock fastening screws
- Type D1 with self-drilling spiral point and high duplex thread with "Quadrex" socket
- Sharp tip for quick drive



Dummy Conversion Kit

Description	PU	Part Number
Cover ring and screws for BERKELEY handles	1	K-C2056-00-0-*
* = Color		PU = Packaging Unit
01 = Satin Nickel, 25 = Dark Bronze, 28 = Pewter, 6 = Black PC		



Additional information

- Used to convert the active to dummy
- 3 screws included to lock the mechanism
- For double doors:
 - active door with keyway
 - inactive door with blank cover

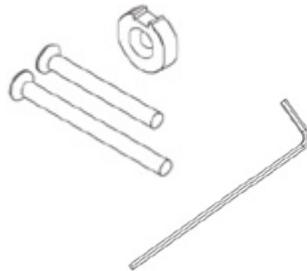
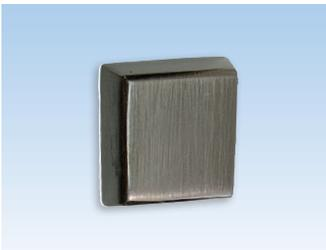

Bottom Ring Cap

Description	PU	Part Number
Cap for BERKELEY handle	1	K-C2052-00-0-*
* = Color		PU = Packaging Unit
01 = Satin Nickel, 25 = Dark Bronze, 28 = Pewter, 6 = Black PC		

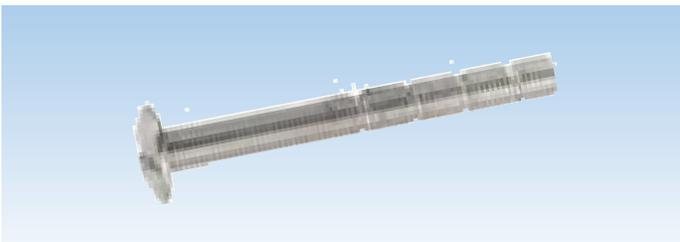

Re-cuttable M5 Screw

Description	PU	Part Number
M5 x 90mm screws for 41-76 mm thick doors (2 screws are supplied with door handle kit)	1	9-U2510-90-R-*
* = Color		PU = Packaging Unit
01 = Satin Nickel, 25 = Dark Bronze, 28 = Pewter, 6 = Black PC		



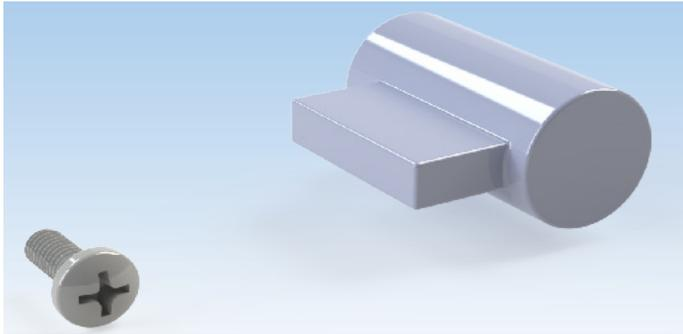

Dummy conversion kit

Description	PU	Part Number
Dummy conversion kit	1	K-C0971-00-0-*
* = Color		PU = Packaging Unit

11 = Satin Nickel, 25 = Dark Bronze



Additional information

- Made of Brass
- Bag of one dummy cylinder and one M4 x 10mm PH screw
- Used to convert the Berlin gripset handles active to dummy
- Part not required for active handles



Replacement Snap & Turn box

Description	PU	Part Number
Snap & Turn Box	1	K-C2057-00-0-0
		PU = Packaging Unit

Additional information

- Bag of one box and four M4 x 8mm FH/PH screws
- Included with Berlin gripset handles

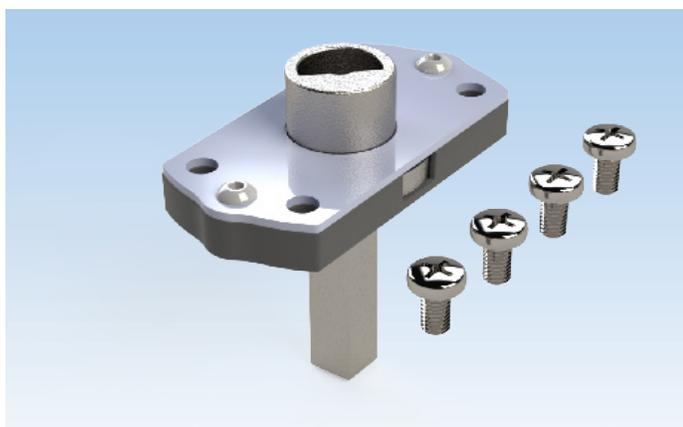

Replacement Springload box

Description	PU	Part Number
Springload Box	1	K-C2058-00-0-0
		PU = Packaging Unit

Additional information

- Bag of one box and four M4 x 8mm PH screws
- Included with Berlin gripset handles



Set Screw

Description	Color	PU	Part Number
M5 set screw <i>(1 screw is included with interior handle)</i>	Stainless Steel	1	9-C0527-02-0-8B
* = Color		PU = Packaging Unit	



Allen Key 2,5mm x 100mm

Description	Color	PU	Part Number
Allen key <i>(1 Allen key is supplied with door handle kit)</i>	Black	1	9-C0955-10-0-0
* = Color		PU = Packaging Unit	



Allen T-Key 2,5mm x 152mm

Description	Color	PU	Part Number
Allen key	Steel	1	6-C0560-20-0-0
* = Color		PU = Packaging Unit	

Additional information

- Used for connecting SH2 and Automatic extensions



Universal Actuators

Description	Color	PU	Part Number
Kit for 1 3/4" doors <i>(Supplied with gripset handle)</i>	Steel	1	K-C2054-45-0-0
Kit for 2 1/4" doors	Steel	1	K-C2054-57-0-0
Kit for 2 3/4" doors	Steel	1	K-C2054-70-0-*
Kit for 3" doors	Steel	1	K-C2054-76-0-*

* = Color PU = Packaging Unit

01 = Satin Nickel, 25 = Dark Bronze, 28 = Pewter, 6 = Black PC



Additional information

- Non-handed
- Accessories included
- Cylinder with longer tail included in kit for 2 3/4" and 3" doors
- For dummy handles, use actuator included, for any door thickness



Cylinders Schlag "C" Keyway

Description	Color	PU	Part Number
① Cylinder with 52mm tail and set of three keys	Zinc	1	6-C0971-52-0-1
	Brass	1	6-C0971-52-0-3
	Dark Bronze	1	6-C0971-52-0-25
② Cylinder with 64mm tail and set of three keys	Zinc	1	6-C0971-64-0-1
	Dark Bronze	1	6-C0971-64-0-25
③ Cylinder with 90 mm tail and set of three keys	Zinc	1	6-C0971-90-0-1
	Brass	1	6-C0971-90-0-3
	Dark Bronze	1	6-C0971-90-0-25

* = Color PU = Packaging Unit

Key Alike Cylinders Schlag "C" Keyway

Description	Color	PU	Part Number
① Cylinder with 52mm tail and set of three keys	Zinc	1	6-C0971-52-9-1
	Brass	1	6-C0971-52-9-3
	Dark Bronze	1	6-C0971-52-9-25
② Cylinder with 64mm tail and set of three keys	Zinc	1	6-C0971-64-9-1
	Dark Bronze	1	6-C0971-64-9-25
③ Cylinder with 90mm tail and set of three keys	Zinc	1	6-C0971-90-9-1
	Brass	1	6-C0971-90-9-3
	Dark Bronze	1	6-C0971-90-9-25

* = Color PU = Packaging Unit

- ① For 41-57 mm thick doors with plate 30,45,55mm
- ② For 41-57 mm thick doors with Berlin gripset
- ③ For 41-76 mm thick doors



Berkeley Correction Kit

Description	Color	PU	Part Number
Berkeley Correction Kit	Steel	1	K-C0010-01-0-0
PU = Packaging Unit			

Accessories

for Strike Plate



Dust Cup with Edge- 25mm

Description	Color	PU	Part Number
Plastic cup	Black	10	9-C4765-00-0-6
		100	9-C4765-1C-0-6
		500	9-C4765-5C-0-6
* = Color		PU = Packaging Unit	

Additional information

- Use for latch and 2 automatic latches (optional)
- Dimensions:
 - Length: 62mm
 - Width: 19.5mm
 - Depth: 25.8mm



Dust Cup without Edge- 15mm

Description	Color	PU	Part Number
Plastic cup	Black	10	9-C4765-0A-0-6
		100	9-C4765-1C-A-6
		500	9-C4765-5C-A-6
* = Color		PU = Packaging Unit	

Additional information

- Dimensions:
 - Length: 62mm
 - Width: 19.5mm
 - Depth: 16mm



Screws for Strike Plates

Description	PU	Part Number
#8 x 5/8" (16mm) screws	10	K-C4763-16-6*
* = Color		PU = Packaging Unit
11 = Satin Nickel, 5 = Dark Bronze, 28 = Pewter, 6 = Black		



Additional information

- Bag of 6 screws for strike plates
- #8 x 5/8" FH/PH screws



Construction Handle Set

Description	Color	PU	Part Number
Construction handle	Black	25	K-C9250-25-0-6
* = Color		PU = Packaging Unit	

Additional information

- Reinforced nylon temporary door trim sets
- 8 x 8 x 90mm square spindle included
- 4.2 x 50mm screws included
- For 1 3/4" thick doors
- Locking/Unlocking from inside only



Construction Key

Description	Color	PU	Part Number
Construction key	Black	10	9-U0001-01-0-0
* = Color		PU = Packaging Unit	

Additional information

The construction key is available for those who prefer to install the decorative hardware trim and lever sets on doors after the construction has been completed. Installing the escutcheon plates and levers in the final stage of construction prevents the decorative trim from becoming scratched or damaged.

The construction key has been designed to accommodate multipoint door hardware (8mm square), tilt-turn hardware (7mm square) and lift-slide hardware (10mm square).

Handle Display

for Gripset Handle and Door Lock



Handle Display with Door Lock and BERKELEY Gripset Handle

Description	PU	Part Number
Handle display – 45mm (1 3/4") thick	1	K-C9617-00-0-9*
Handle display – Danalock Smart Lock	1	K-C9617-SL-0-9*
Handle display – Tedee Smart Lock	1	K-C9617-SL-T-9*

* = Color PU = Packaging Unit

01 = Satin Nickel, 25 = Dark Bronze, 28 = Pewter, 6 = Black



Additional information

- HandleDisplay complete with gripset handle and SECURY Automatic sample gear
- Berkeley handle with Danalock smart lock with K-C9617-SL-0-9
- Berkeley handle with Tedee smart lock with K-C9617-SL-T-9
- When ordering, please add note for finish

03
3

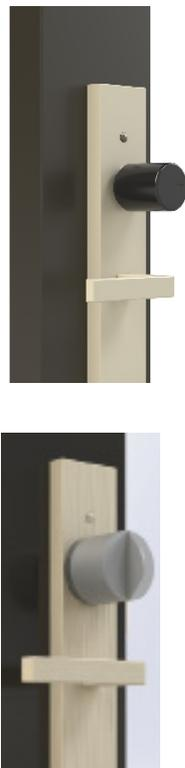

Handle Display with Door Lock and Berlin Gripset Handle

Description	PU	Part Number
Handle display – 45mm (1 3/4") thick	1	K-C9641-00-0-9
Handle display – Danalock Smart Lock	1	K-C9641-SL-0-9
Handle display – Tedee Smart Lock	1	K-C9641-SL-T-9

* = Color PU = Packaging Unit

11 = Satin Nickel, 5 = Dark Bronze, 28 = Pewter, 6 = Black

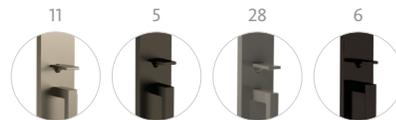

Additional information

- Handle complete with gripset handle and SECURY Automatic sample gear
- Berlin handle with Danalock smart lock with K-C9617-SL-0-9
- Berlin handle with Tedee smart lock with K-C9641-SL-T-9
- When ordering, please add note for finish

Handle Display

for Gripset Handle and Door Lock



Handle Display for Gripset

Description	PU	Part Number
BERLIN	1	K-C9608-A1-0-7*
Display Base	1	6-C9602-00-0-6
PU = Packaging Unit		

01 = Satin Nickel, 25 = Dark Bronze, 28 = Pewter, 6 = Black

* Models in this table are also available in French

- Display delivered with wall mounted kit
- The display base is an option to place the unit on a desk, to be ordered separately
- 21"1/2 x 32" x 12" (53.2 cm x 80.25 cm x 30.5 cm)



WINDOW TECHNOLOGY
DOOR TECHNOLOGY
AUTOMATIC ENTRANCE SYSTEMS
BUILDING MANAGEMENT SYSTEMS

HEAD OFFICE

Ferco Architectural Hardware Inc.
2000, Berlier St.
Laval, QC H7L 4S4
Tel.: 450 973-1437
1 800 355-8810
Fax: 450 973-7661
ferco@ferco.ca

ONTARIO / WESTERN PROVINCES

Tel.: 905 282-9588
1 800 668-5310
Fax: 905 282-9915

UNITED STATES

Tel.: 1 800 927-1097
Fax: 1 888 454-0161

www.ferco.ca

Edition 05.2022 | Printed in Canada

Securing technology for you

