



WINDOW TECHNOLOGY
DOOR TECHNOLOGY
AUTOMATIC ENTRANCE SYSTEMS
BUILDING MANAGEMENT SYSTEMS



DOOR TECHNOLOGY – ORDER CATALOG | SECTION 03.2



SECURY Automatic Door Lock & Lever Handle



Securing technology for you





03.2

SECURY Automatic Door Lock & Lever Handle

GEARS

SECURY Automatic Door Lock	03.2.3
Automatic Extension	03.2.4
Filler Pieces	03.2.5
Mortise Door Lock	03.2.6

HANDLES

Introduction	03.2.7
Finishes for handle set program	03.2.8

30mm Plate Series

ALLEGRO Trim Kits	03.2.10
TORINO Trim Kits	03.2.11
VENICE Trim Kits	03.2.12

45mm Plate Series

CAPRI Trim Kits	03.2.13
TORINO Trim Kits	03.2.14
VENICE Trim Kits	03.2.15

55mm Plate Series

ROMA Trim Kits	03.2.16
----------------------	---------

65mm Plate Series & BELCANTO Handle

BERLIN Trim Kits	03.2.17
BERLIN Trim Kits	03.2.18
Belcanto Handle & US Rosette	03.2.19

ACCESSORIES

Smart locks	03.2.20
Strike Plates	03.2.26
Accessories	03.2.29

Handle Displays	03.2.38
-----------------------	---------

SECURY Automatic Door Lock

for lever handle with North American Cylinder



Unlocked



Locked

USE WITH LEVER HANDLES ONLY

SECURY Automatic Door Lock for Lever Handle

Description	Backset	Color	PU	Part Number
Door lock for 6' 8" doors	45mm	SS	5	6-35856-01-R-8B
Door lock for 8' doors	45mm	SS	5	6-35856-02-R-8B
Door lock for 6' 8" doors	50mm	SS	5	6-36033-01-R-8B
Door lock for 8' doors	50mm	SS	5	6-36033-02-R-8B
Door lock for 6' 8" doors	60mm	SS	5	6-35565-01-R-8B
Door lock for 8' doors	60mm	SS	5	6-35565-02-R-8B

PU = Packaging Unit

Simply Close the Door!

As soon as the door pulled shut, the Automatic latchbolts instantly throw 20mm and are secured to prevent them being forced back. By turning the key or the knob, the center deadbolt will engage and lock the top and bottom latchbolts to become a **3-deadbolt locking system**.

Additional information

- 3-point, one piece locking system for 6' 8" and 8' doors
- Heavy duty mortise construction with reinforced lever return spring system
- Locking by US-cylinder with 90° turn of key or thumb-turn
- No lifting of handle to engage locking points
- Top and bottom Automatic latchbolt projection from 10 to 20mm:
 - Provides security
 - Protects the door
- 1" (25mm) throw on deadbolt with baby sitting function
- Non handed, latch easily reversible
- 8mm square spindle
- 92mm centres (spindle to cylinder)
- Handle height variable (36" recommended)
- 16mm stainless steel faceplate with radius ends for easy installation and cleaner look
- Same hardware groove detail throughout our entire door lock program (jig, router base and bits available)
- Various extension with additional lock point is available for doors taller than 8'
- To be used with lever handle set (US-cylinder above handle)

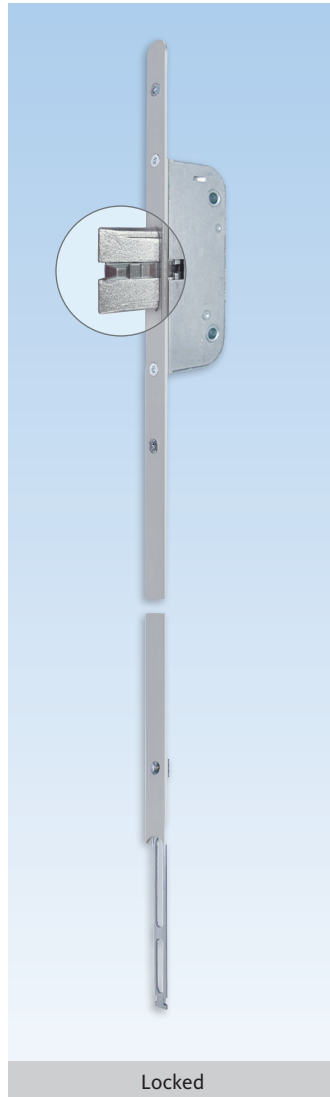
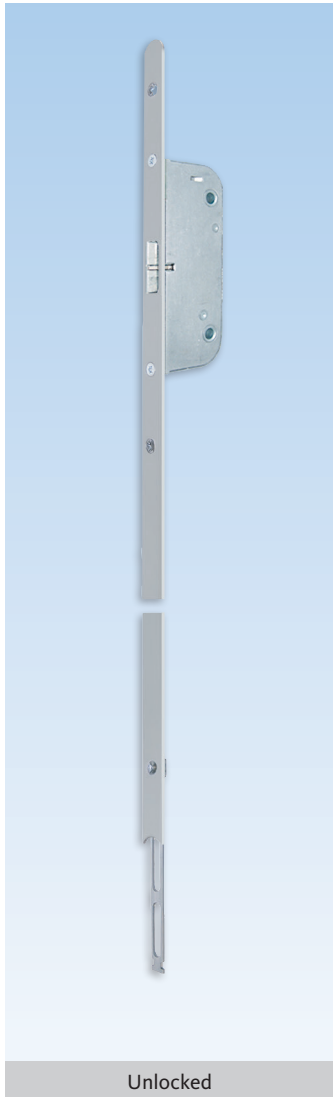

Extension with Additional Latchbolt

Description	Color	PU	Part Number
525mm extension with rounded end	Stainless Steel	5	6-33479-04-0-8B
800mm extension with rounded end	Stainless Steel	1	6-C5078-00-0-8B
1050mm extension with rounded end	Stainless Steel	1	6-C5062-10-0-8B
1325mm extension with rounded end	Stainless Steel	1	6-C5062-13-0-8B

* = Color PU = Packaging Unit

Additional information

- Tapered latch always engaging in strike plate
- 16mm stainless steel faceplate with radius end for easy installation and cleaner look
- Additional locking point for doors taller than 8'
- To be used with GU-SECURY Automatic door Locks

Filler pieces

Round to square

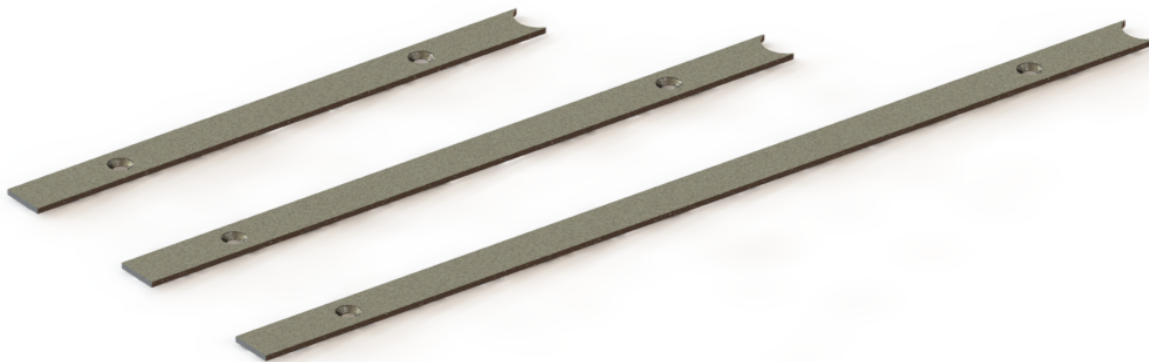

Filler Pieces

Description	PU	Part Number
Filler piece 193,7mm	1	9-C4340-19-0-8B
Filler piece 245,9mm	1	9-C4342-24-0-8B
Filler piece 342,3mm	1	9-C4342-34-0-8B

Additional information

- Made of stainless steel
- To be used with radius end locks and extensions

Formulas to select filler length:

- Bottom:
L = Handle height - 671,7mm
- Top 1590mm lock:
L = Door height - handle height - extension(s) length - 920,7mm
- Top 1900mm lock:
L = Door height - handle height - extension(s) length - 1230,7mm

03
2

Mortise Door Lock

with Latch and Deadbolt



Unlocked



Locked

Mortise Door Lock for Lever Handle

Description	Color	PU	Part Number
Door lock with 45mm backset	Stainless Steel	10	6-C4893-45-0-8
Door lock with 50mm backset	Stainless Steel	10	6-C4893-50-0-8
Door lock with 60mm backset	Stainless Steel	10	6-C4893-60-0-8

* = Color PU = Packaging Unit

Additional information

- Heavy duty mortise construction with reinforced lever return spring system
- Locking by US-cylinder with 90° turn of key or thumb-turn to engage the 1" (25mm) deadbolt
- Non-handed, latch easily reversible
- 8mm square spindle
- 92mm centres (spindle to cylinder)
- 16mm stainless steel faceplate with radius ends for easy installation and cleaner look
- Same hardware groove detail throughout our entire door lock program (jig, router base and bits available)
- Ideal for exterior and interior door applications
- To be used with lever handle set (US-cylinder above handle)



Ferco lever handle sets are uniquely designed to operate on multipoint door locks. Our handle sets withstand the rigorous everyday operational wear & tear of engaging or disengaging multiple lock points. **Our handle sets are designed for long term use!**

- **Patented handle snap-rings** allow for handles to be shipped non-handed. The manufacturer no longer has to worry about ordering left or right, and will save on inventory.
- **Handle setscrews to fasten spindles** combined with the snap-ring will ensure the handle will stay tight on the door for a long time.
- **Self centering 8mm split Spindle** to make sure it is always centered into the door.
- **Longer Screw ports on escutcheons:** Ferco has added an interior sleeve port that will guide the M5 mm screw straight to the opposing exterior screw port.
- **Exterior O-ring on handle shaft** to prevent water from entering around the exterior handle.
- **Washers between handle and escutcheon** making sure the handle operation is and remains smooth.
- **Escutcheon Foam gasket** to prevent air and cold.
- **Rubber gasket** (Order separately) to prevent air and water leakage around the exterior escutcheon.
- **Schlage Cylinder with one tail for both 1 ¾” and 2 ¼” thick doors**
- **M5 handle set screws to fasten the escutcheons** included in every handle set kit.
- **Handle above cylinder or handle below cylinder option**
- **FERCO handle sets available** in Solid Brass or economical zinc die-cast material with selections in many plate designs, lever styles and finishes.

Finishes For Handle Set Program

- US-Cylinder Above Handle



	SOLID BRASS						ZAMAC					
	45mm PLATE			30mm PLATE			45mm PLATE			30mm PLATE		
	CAPRI K-U6292-01 K-U6246-00 K-U6210-00	TORINO K-U6492-01 K-U6446-00 K-U6410-00	VENICE K-U6692-01 K-U6646-00 K-U6610-00	ALLEGRO K-U3192-01 K-U3146-00 K-U3110-00	TORINO K-U3492-01 K-U3446-00 K-U3410-00	VENICE K-U3692-01 K-U3646-00 K-U3610-00	CAPRI K-U7292-Z1 K-U7246-Z0 K-U7210-Z0	TORINO K-U7492-Z1 K-U7446-Z0 K-U7410-Z0	VENICE K-U7692-Z1 K-U7646-Z0 K-U7610-Z0	ALLEGRO K-U5192-Z1 K-U5146-Z0 K-U5110-Z0	TORINO K-U5492-Z1 K-U5446-Z0 K-U5410-Z0	VENICE K-U5692-Z1 K-U5646-Z0 K-U5610-Z0
Satin Chrome	01	01	01	01	01	01				01	01	01
Polished Brass	03	03	03	03	03	03						
Antique Brass	04	04	04	04	04	04						
Oil Rubbed Bronze	05	05	05	05	05	05						
Dark Bronze PC							5	5	5	5	5	5
Black PC							6	6	6	6	6	6
White PC							7	7	7	7	7	7
Satin Nickel	11	11	11	11	11	11						
Dark Bronze	25	25	25	25	25	25						
Pewter	28	28	28	28	28	28		28	28	28	28	28







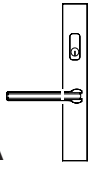
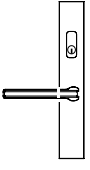
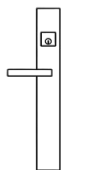
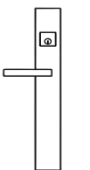

Colors on this document are graphic representation and may not be an exact match for the actual painted/plated hardware.
For color selection, material samples are available on request.

* information in this document can be modified without notice. Finishes Handle Sets Program_03-2021

Finishes For Handle Set Program

- US-Cylinder Above Handle



	SOLID BRASS 55mm PLATE	ZAMAC 55mm PLATE	SOLID BRASS 65mm PLATE	ZAMAC 65mm PLATE
	 ROMA K-U4092-01 K-U4046-00 K-U4010-00	 ROMA K-U9092-Z1 K-U9046-Z0 K-U9010-Z0	 BERLIN K-U2592-Z1 K-U2546-Z0 K-U2510-Z0	 BERLIN K-U8592-Z1 K-U8546-Z0 K-U8510-Z0
Satin Chrome				
Polished Brass				
Antique Brass				
Oil Rubbed Bronze				
Dark Bronze PC				5 
Black PC		6 		6 
White PC				
Satin Nickel	11 		11 	
Dark Bronze	25 			
Pewter	28 		28 	

Colors on this document are graphic representation and may not be an exact match for the actual painted/plated hardware. For color selection, material samples are available on request.

ALLEGRO Handles & 30mm Plates



ALLEGRO Solid brass Trim Kits

Description	PU	Part Number
Handle sets for active doors with US-cylinder	1	K-U3192-01-0-*
Handle sets for semi-active doors	1	K-U3146-00-0-*
Handle sets for fixed doors	1	K-U3110-00-0-*

* = Color PU = Packaging Unit

01 = Satin Chrome, 03 = Polished Brass, 04 = Antique Brass, 05 = Oil Rubbed Bronze, 11 = Satin Nickel, 25 = Dark Bronze, 28 = Pewter

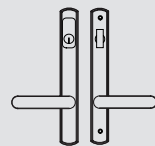
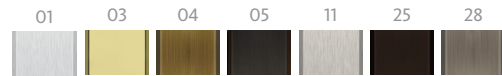

K-U3192-01-0-*

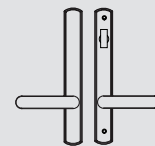

K-U3146-00-0-*

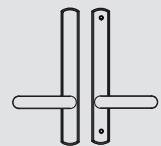

K-U3110-00-0-*

Additional information

- Unassembled solid brass trim kits
- US-cylinder with standard 5 pins Schlage "C" keyway
- 90° locking with thumb-turn
- Self-centering 8mm spindle

- Stainless steel set screw on levers to secure spindle
- Patented handle clipping system
- Kit for 1 3/4" and 2 1/4" thick doors
- US-cylinder above handle



ALLEGRO Zamac Trim Kits

Description	PU	Part Number
Handle sets for active doors with US-cylinder	1	K-U5192-Z1-0-*
Handle sets for semi-active doors	1	K-U5146-Z0-0-*
Handle sets for fixed doors	1	K-U5110-Z0-0-*

* = Color PU = Packaging Unit

01 = Satin Chrome, 5 = Dark Bronze PC, 6 = Black PC, 7 = White PC, 28 = Pewter

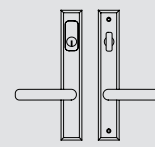
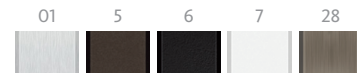

K-U5192-Z1-0-*

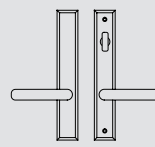

K-U5146-Z0-0-*

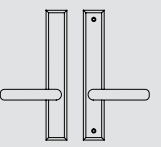

K-U5110-Z0-0-*

Additional information

- Unassembled zamac trim kits
- US-cylinder with standard 5 pins Schlage "C" keyway
- 90° locking with thumb-turn
- Self-centering 8mm spindle

- Stainless steel set screw on levers to secure spindle
- Patented handle clipping system
- Kit for 1 3/4" and 2 1/4" thick doors
- US-cylinder above handle

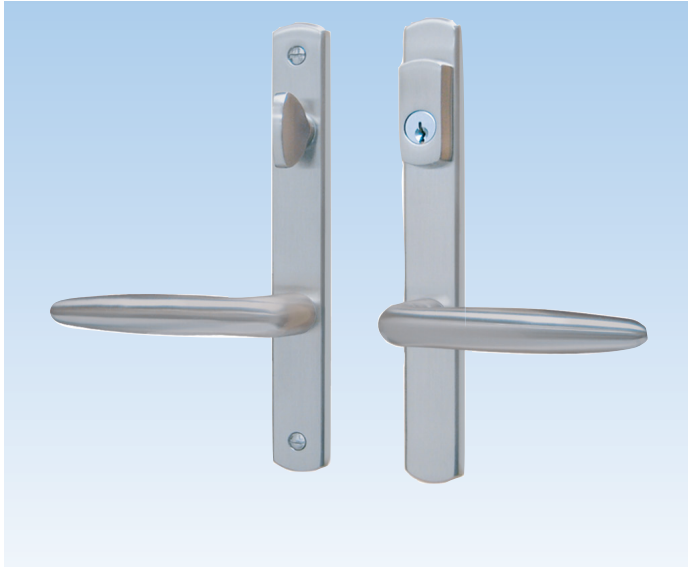

Additional information

- Unassembled solid brass trim kits
- US-cylinder with standard 5 pins Schlage "C" keyway
- 90° locking with thumb-turn
- Self-centering 8mm spindle

TORINO Solid brass Trim Kits

Description	PU	Part Number
Handle sets for active doors with US-cylinder	1	K-U3492-01-0-*
Handle sets for semi-active doors	1	K-U3446-00-0-*
Handle sets for fixed doors	1	K-U3410-00-0-*

* = Color PU = Packaging Unit

01 = Satin Chrome, 03 = Polished Brass, 04 = Antique Brass, 05 = Oil Rubbed Bronze, 11 = Satin Nickel, 25 = Dark Bronze, 28 = Pewter

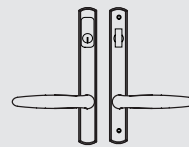
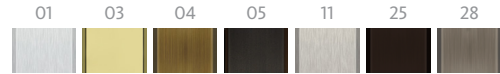

K-U3492-01-0-*

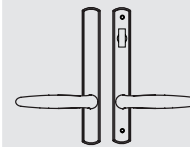

K-U3446-00-0-*

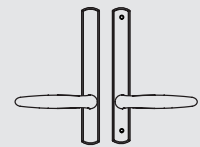

K-U3410-00-0-*

- Stainless steel set screw on levers to secure spindle
- Patented handle clipping system
- Kit for 1 3/4" and 2 1/4" thick doors
- US-cylinder above handle



Additional information

- Unassembled zamac trim kits
- US-cylinder with standard 5 pins Schlage "C" keyway
- 90° locking with thumb-turn
- Self-centering 8mm spindle

TORINO Zamac Trim Kits

Description	PU	Part Number
Handle sets for active doors with US-cylinder	1	K-U5492-Z1-0-*
Handle sets for semi-active doors	1	K-U5446-Z0-0-*
Handle sets for fixed doors	1	K-U5410-Z0-0-*

* = Color PU = Packaging Unit

01 = Satin Chrome, 5 = Dark Bronze PC, 6 = Black PC, 7 = White PC, 28 = Pewter

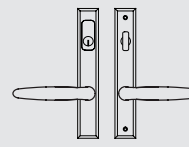
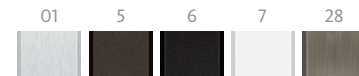

K-U5492-Z1-0-*

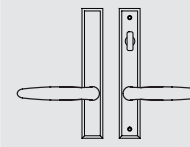

K-U5446-Z0-0-*

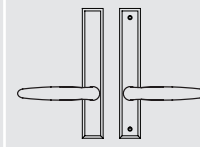

K-U5410-Z0-0-*

- Stainless steel set screw on levers to secure spindle
- Patented handle clipping system
- Kit for 1 3/4" and 2 1/4" thick doors
- US-cylinder above handle

VENICE Handle & 30mm Plate



VENICE Solid Brass Trim Kits

Description	PU	Part Number
Handle sets for active doors with US-cylinder	1	K-U3692-01-0-*
Handle sets for semi-active doors	1	K-U3646-00-0-*
Handle sets for fixed doors	1	K-U3610-00-0-*

* = Color PU = Packaging Unit

01 = Satin Chrome, 03 = Polished Brass, 04 = Antique Brass, 05 = Oil Rubbed Bronze, 11 = Satin Nickel, 25 = Dark Bronze, 28 = Pewter

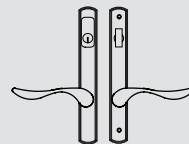
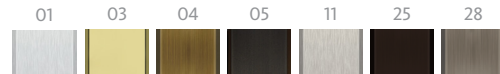

K-U3692-01-0-*

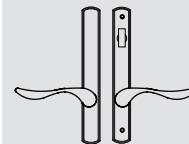

K-U3646-00-0-*

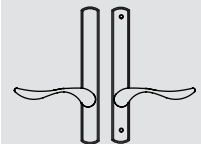

K-U3610-00-0-*

Additional information

- Unassembled solid brass trim kits
- US-cylinder with standard 5 pins Schlage "C" keyway
- 90° locking with thumb-turn
- Self-centering 8mm spindle

- Stainless steel set screw on levers to secure spindle
- Patented handle clipping system
- Kit for 1 3/4" and 2 1/4" thick doors
- US-cylinder above handle



VENICE Zamac Trim Kits

Description	PU	Part Number
Handle sets for active doors with US-cylinder	1	K-U5692-Z1-0-*
Handle sets for semi-active doors	1	K-U5646-Z0-0-*
Handle sets for fixed doors	1	K-U5610-Z0-0-*

* = Color PU = Packaging Unit

01 = Satin Chrome, 5 = Dark Bronze PC, 6 = Black PC, 7 = White PC, 28 = Pewter

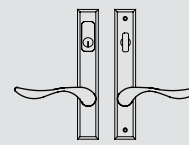
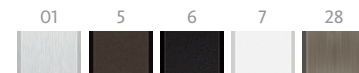

K-U5692-Z1-0-*

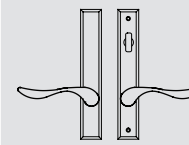

K-U5646-Z0-0-*

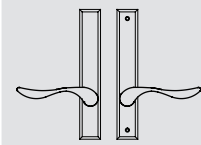

K-U5610-Z0-0-*

Additional information

- Unassembled zamac trim kits
- US-cylinder with standard 5 pins Schlage "C" keyway
- 90° locking with thumb-turn
- Self-centering 8mm spindle

- Stainless steel set screw on levers to secure spindle
- Patented handle clipping system
- Kit for 1 3/4" and 2 1/4" thick doors
- US-cylinder above handle



Additional information

- Unassembled solid brass trim kits
- US-cylinder with standard 5 pins Schlage "C" keyway
- 90° locking with thumb-turn
- Self-centering 8mm spindle

CAPRI Solid Brass Trim Kits

Description	PU	Part Number
Handle sets for active doors with US-cylinder	1	K-U6292-01-0-*
Handle sets for semi-active doors	1	K-U6246-00-0-*
Handle sets for fixed doors	1	K-U6210-00-0-*

* = Color PU = Packaging Unit

01 = Satin Chrome, 03 = Polished Brass, 04 = Antique Brass, 05 = Oil Rubbed Bronze, 11 = Satin Nickel, 25 = Dark Bronze, 28 = Pewter

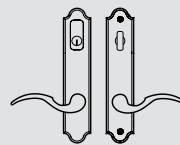
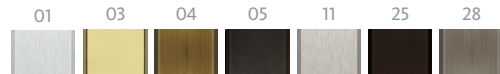

K-U6292-01-0-*

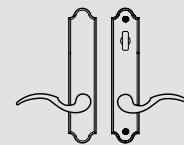

K-U6246-00-0-*

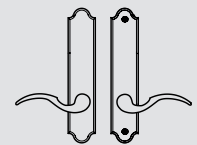

K-U6210-00-0-*

- Stainless steel set screw on levers to secure spindle
- Patented handle clipping system
- Kit for 1 3/4" and 2 1/4" thick doors
- US-cylinder above handle

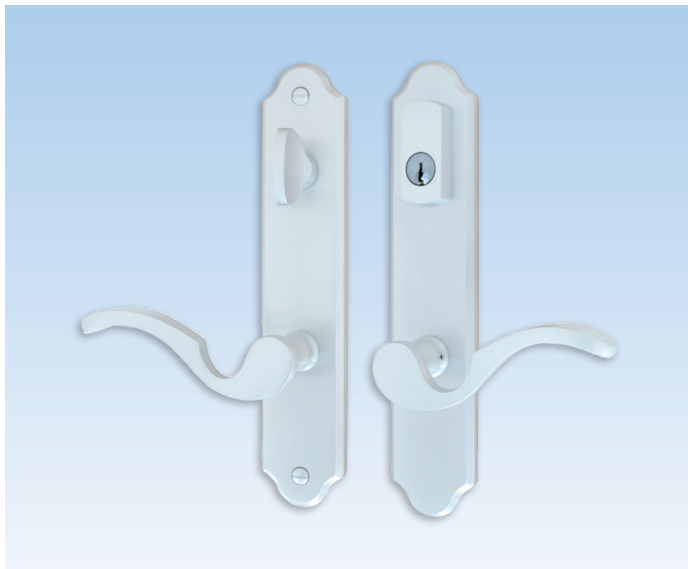

Additional information

- Unassembled zamac trim kits
- US-cylinder with standard 5 pins Schlage "C" keyway
- 90° locking with thumb-turn
- Self-centering 8mm spindle

CAPRI Zamac Trim Kits

Description	PU	Part Number
Handle sets for active doors with US-cylinder	1	K-U7292-Z1-0-*
Handle sets for semi-active doors	1	K-U7246-Z0-0-*
Handle sets for fixed doors	1	K-U7210-Z0-0-*

* = Color PU = Packaging Unit

5 = Dark Bronze PC, 6 = Black PC, 7 = White PC

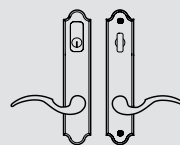
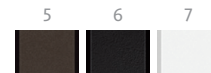

K-U7292-Z1-0-*

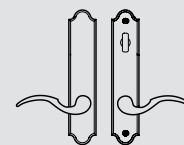

K-U7246-Z0-0-*

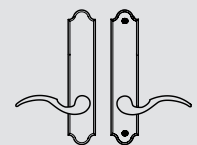

K-U7210-Z0-0-*

- Stainless steel set screw on levers to secure spindle
- Patented handle clipping system
- Kit for 1 3/4" and 2 1/4" thick doors
- US-cylinder above handle



TORINO Solid Brass Trim Kits

Description	PU	Part Number
Handle sets for active doors with US-cylinder	1	K-U6492-01-0-*
Handle sets for semi-active doors	1	K-U6446-00-0-*
Handle sets for fixed doors	1	K-U6410-00-0-*

* = Color PU = Packaging Unit

01 = Satin Chrome, 03 = Polished Brass, 04 = Antique Brass, 05 = Oil Rubbed Bronze, 11 = Satin Nickel, 25 = Dark Bronze, 28 = Pewter

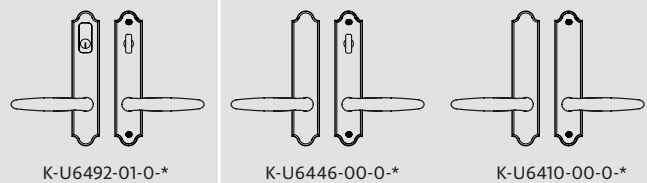
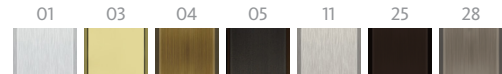

Additional information

- Unassembled solid brass trim kits
- US-cylinder with standard 5 pins Schlage "C" keyway
- 90° locking with thumb-turn
- Self-centering 8mm spindle

- Stainless steel set screw on levers to secure spindle
- Patented handle clipping system
- Kit for 1 3/4" and 2 1/4" thick doors
- US-cylinder above handle



TORINO Zamac Trim Kits

Description	PU	Part Number
Handle sets for active doors with US-cylinder	1	K-U7492-Z1-0-*
Handle sets for semi-active doors	1	K-U7446-Z0-0-*
Handle sets for fixed doors	1	K-U7410-Z0-0-*

* = Color PU = Packaging Unit

01 = Satin Chrome, 5 = Dark Bronze, 6 = Black, 7 = White, 28 = Pewter

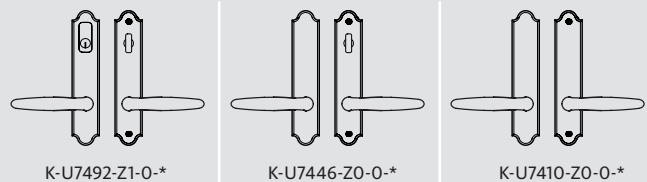
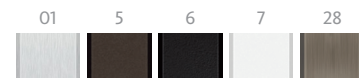

Additional information

- Unassembled zamac trim kits
- US-cylinder with standard 5 pins Schlage "C" keyway
- 90° locking with thumb-turn
- Self-centering 8mm spindle

- Stainless steel set screw on levers to secure spindle
- Patented handle clipping system
- Kit for 1 3/4" and 2 1/4" thick doors
- US-cylinder above handle

VENICE Handle & 45mm Plate



VENICE Solid Brass Trim Kits

Description	PU	Part Number
Handle sets for active doors with US-cylinder	1	K-U6692-01-0-*
Handle sets for semi-active doors	1	K-U6646-00-0-*
Handle sets for fixed doors	1	K-U6610-00-0-*

* = Color PU = Packaging Unit

01 = Satin Chrome, 03 = Polished Brass, 04 = Antique Brass, 05 = Oil Rubbed Bronze, 11 = Satin Nickel, 25 = Dark Bronze, 28 = Pewter

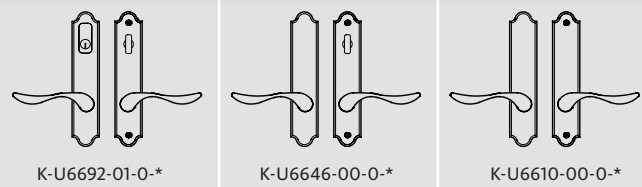
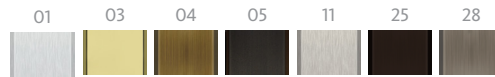

Additional information

- Unassembled solid brass trim kits
- US-cylinder with standard 5 pins Schlage "C" keyway
- 90° locking with thumb-turn
- Self-centering 8mm spindle

- Stainless steel set screw on levers to secure spindle
- Patented handle clipping system
- Kit for 1 3/4" and 2 1/4" thick doors
- US-cylinder above handle



VENICE Zamac Trim Kits

Description	PU	Part Number
Handle sets for active doors with US-cylinder	1	K-U7692-Z1-0-*
Handle sets for semi-active doors	1	K-U7646-Z0-0-*
Handle sets for fixed doors	1	K-U7610-Z0-0-*

* = Color PU = Packaging Unit

01 = Satin Chrome, 5 = Dark Bronze PC, 6 = Black PC, 7 = White PC, 28 = Pewter

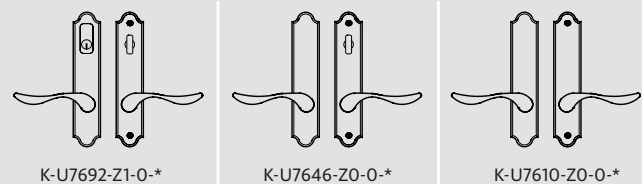
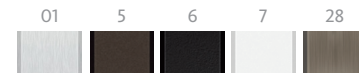

Additional information

- Unassembled zamac trim kits
- US-cylinder with standard 5 pins Schlage "C" keyway
- 90° locking with thumb-turn
- Self-centering 8mm spindle

- Stainless steel set screw on levers to secure spindle
- Patented handle clipping system
- Kit for 1 3/4" and 2 1/4" thick doors
- US-cylinder above handle



Additional information

- Unassembled solid brass trim kits
- US-cylinder with standard 5 pins Schlage "C" keyway
- 90° locking with thumb-turn
- Self-centering 8mm spindle



Additional information

- Unassembled zamac trim kits
- US-cylinder with standard 5 pins Schlage "C" keyway
- 90° locking with thumb-turn
- Self-centering 8mm spindle

ROMA Solid Brass Trim Kits

Description	PU	Part Number
Handle sets for active doors with US-cylinder	1	K-U4092-01-0-*
Handle sets for semi-active doors	1	K-U4046-00-0-*
Handle sets for fixed doors	1	K-U4010-00-0-*
Handle sets for Danalock smart lock	1	K-U4092-D0-0-*
Handle sets for Tedee smart lock	1	K-U4092-T1-0-*

* = Color PU = Packaging Unit

11 = Satin Nickel, 25 = Dark Bronze, 28 = Pewter

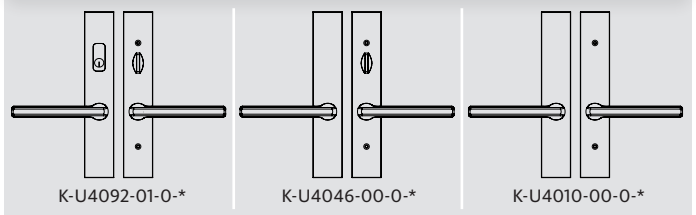
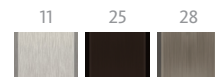

- Stainless steel set screw on levers to secure spindle
- Patented handle clipping system
- Kit for 1 3/4" and 2 1/4" thick doors
- US-cylinder above handle
- Compatible with Danalock V3 and Tedee smart locks

ROMA Zamac Trim Kits

Description	PU	Part Number
Handle sets for active doors with US-cylinder	1	K-U9092-Z1-0-*
Handle sets for semi-active doors	1	K-U9046-Z0-0-*
Handle sets for fixed doors	1	K-U9010-Z0-0-*
Handle sets for Danalock smart lock	1	K-U9092-D0-0-*
Handle sets for Tedee smart lock	1	K-U9092-T1-0-*

* = Color PU = Packaging Unit

6 = Black PC

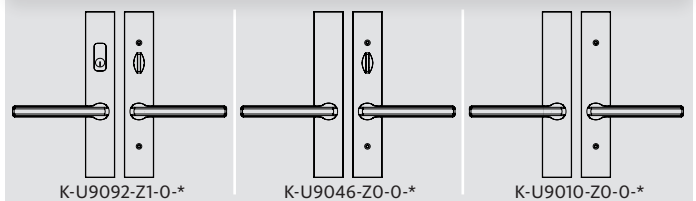

- Stainless steel set screw on levers to secure spindle
- Patented handle clipping system
- Kit for 1 3/4" and 2 1/4" thick doors
- US-cylinder above handle
- Compatible with Danalock V3 and Tedee smart locks

BERLIN Handle & 65mm Plates



BERLIN Solid Brass Trim Kits

Description	PU	Part Number
Handle sets for active doors with US-cylinder	1	K-U2592-01-0-*
Handle sets for semi-active doors	1	K-U2546-00-0-*
Handle sets for fixed doors	1	K-U2510-00-0-*
Handle sets for Danalock smart lock	1	K-U2592-D0-0-*
Handle sets for Tedee smart lock	1	K-U2592-T1-0-*

* = Color

PU = Packaging Unit

11 = Satin Nickel, 28 = Pewter

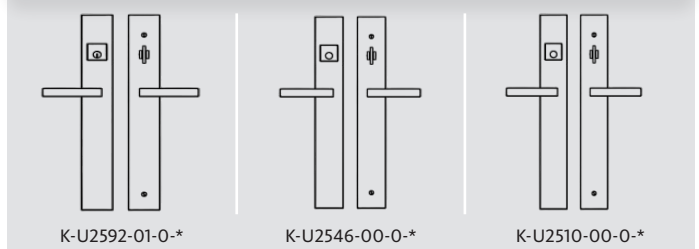
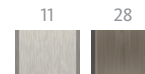

K-U2592-01-0-*

K-U2546-00-0-*

K-U2510-00-0-*

Additional information

- Unassembled Solid Brass trim kits
- US-cylinder with standard 5 pins Schlage "C" keyway
- New snapping mechanism for the 90° locking with thumb-turn
- Self-centering 8mm spindle
- Stainless steel set screw on levers to secure spindle
- Patented handle clipping system
- Kit for 1 3/4" and 2 1/4" thick doors
- US-cylinder above handle
- Compatible with Danalock V3 and Tedee smart locks

- Active trim kits are converted to Semi-Active and Dummy using a pre-assembled cylinder plug and screw-in Dummy brackets (included in the kits)
- Minimum backset required: 50mm



Additional information

- Unassembled Zamac trim kits
- US-cylinder with standard 5 pins Schlage "C" keyway
- New snapping mechanism for the 90° locking with thumb-turn
- Self-centering 8mm spindle
- Stainless steel set screw on levers to secure spindle
- Patented handle clipping system
- Kit for 1 3/4" and 2 1/4" thick doors
- US-cylinder above handle
- Compatible with Danalock V3 and Tedee smart locks

BERLIN Zamac Trim Kits

Description	PU	Part Number
Handle sets for active doors with US-cylinder	1	K-U8592-Z1-0-*
Handle sets for semi-active doors	1	K-U8546-Z0-0-*
Handle sets for fixed doors	1	K-U8510-Z0-0-*
Handle sets for Danalock smart lock	1	K-U8592-D0-0-*
Handle sets for Tedee smart lock	1	K-U8592-T1-0-*

* = Color

PU = Packaging Unit

5 = Dark Bronze PC, 6 = Black PC

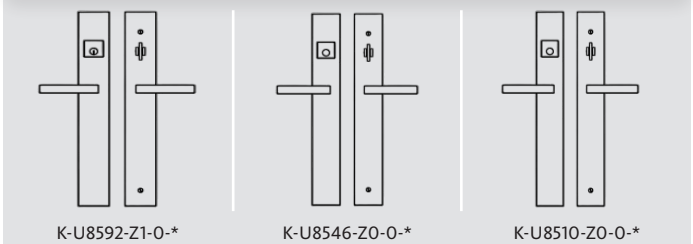
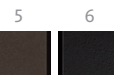

- Active trim kits are converted to Semi-Active and Dummy using a pre-assembled cylinder plug and screw-in Dummy brackets (included in the kits)
- Minimum backset required: 50mm

BELCANTO Handles & US Rosettes

for Door Lock



US rosettes

Description	PU	Part Number
US lock kit for DB	1	K-C0370-00-0-*
US lock cyl. kit without knob for Danalock Smart Lock	1	K-C0370-D0-0-*
US lock cyl. kit without knob for Tedee Smart Lock	1	K-C0370-T1-0-*

* = Color PU = Packaging Unit

8B = Stainless Steel, 6 = Black



Additional information

- Made of stainless steel
- Fastening kit included for 1 3/4" and 2 1/4" doors
- Foam gasket
- Compatible with smart lock (Danalock V3)
- For doors thicker than 2 1/4" up to 2 3/4" use M5 x 80mm (not included) and 90mm cylinder (6-C0971-90-0-1)
- For doors thicker than 2 3/4" up to 3" use M5 x 90mm (not included) and 90mm cylinder (6-C0971-90-0-1)
- US lock cyl. kit for Smart Lock comes without knob and allen key

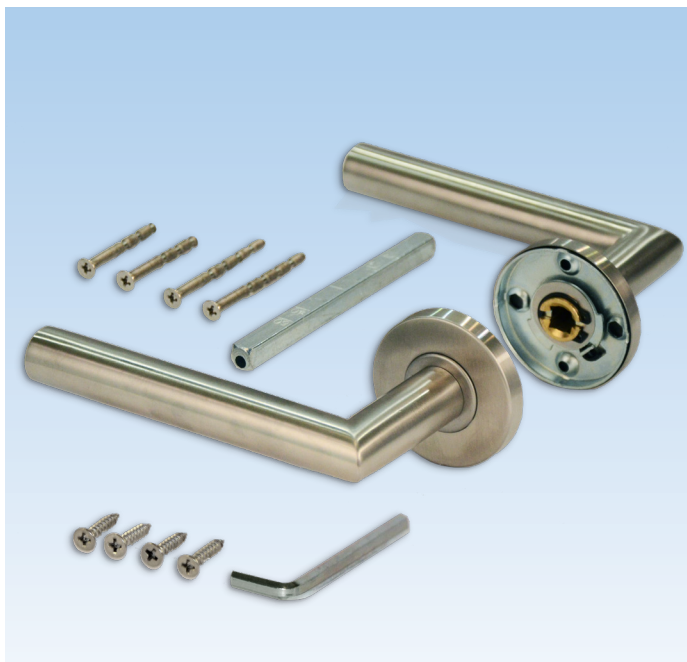

Belcanto Handle Set

Description	PU	Part Number
Kit of inside and outside handles	1	K-C9071-00-0-*

* = Color PU = Packaging Unit

8B = Stainless Steel, 6 = Black



Additional information

- Handles and Rosettes made of stainless steel
- Fastening kit included for 1 3/4" and 2 1/4" doors
- Fixed lever spring loaded - can't be lifted
- 8mm square spindle x 110 mm included
- Concealed fixing screws
- Compatible with smart lock (Danalock V3)
- For doors 3" use screws (9-C0570-90-0-1) and 130mm spindle (9-U8100-30-0-8)

Smart locks

for Door Lock

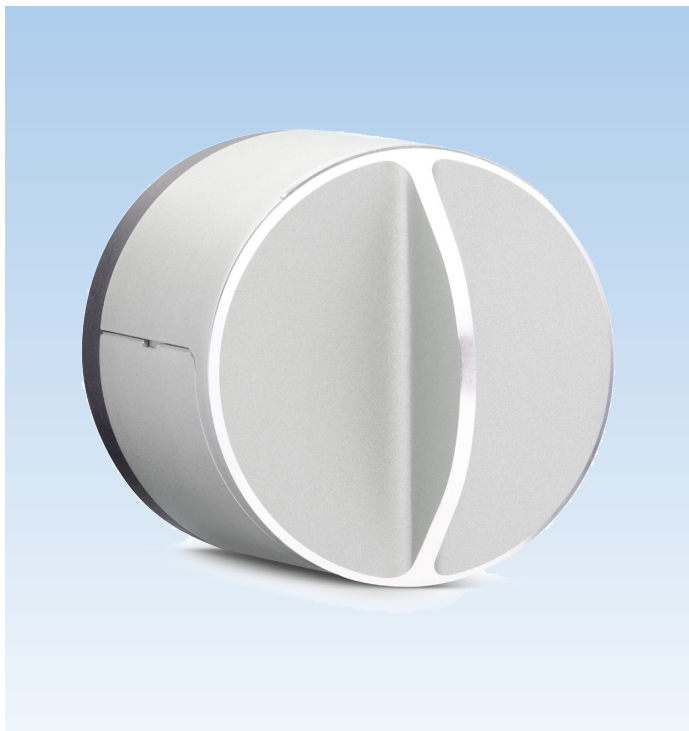

Smart lock

Description	PU	Part Number
Danalock V3 Z-Wave	1	K-C0380-00-0-1
Danalock V3 Bluetooth	1	K-C0380-01-0-*
* = Color		PU = Packaging Unit
1 = Silver, 6 = Black		



Additional information

- 4 X CR123A batteries (included)
- Bluetooth 4.2 (Danalock app)
- Z-Wave (Automation hub - Only available in Silver finish)
- 256bit AES encryption level
- No cut-out modification required (retro-fit)
- Compatible with 55,65 mm plates and US rosettes



Bluetooth keypad

Description	PU	Part Number
Danapad V3	1	6-C9407-00-0-X
* = Color		PU = Packaging Unit
1 = Silver, 6 = Black		



Additional information

- 4 X AAA batteries (included)
- Bluetooth 4.2
- 256bit AES encryption level
- Compatible with smart lock (Danalock V3) and Universal Module



Danabridge Remote Access

Description	PU	Part Number
Danabridge V3	1	6-C9402-00-0-0

Additional information

- 53 mm x 53 mm x 32 mm / Weighs 36 g
- USB power supply
- Add remote access to smart locks (Danalock or Universal Module)
- 2 Smart locks can be controlled with one Danabridge (via Bluetooth 4.2)
- Communication with Wi-Fi 802.11b/g/n



Danalock Accessories

Description	PU	Part Number
Danalock black inner ring	1	9-C0553-00-0-6

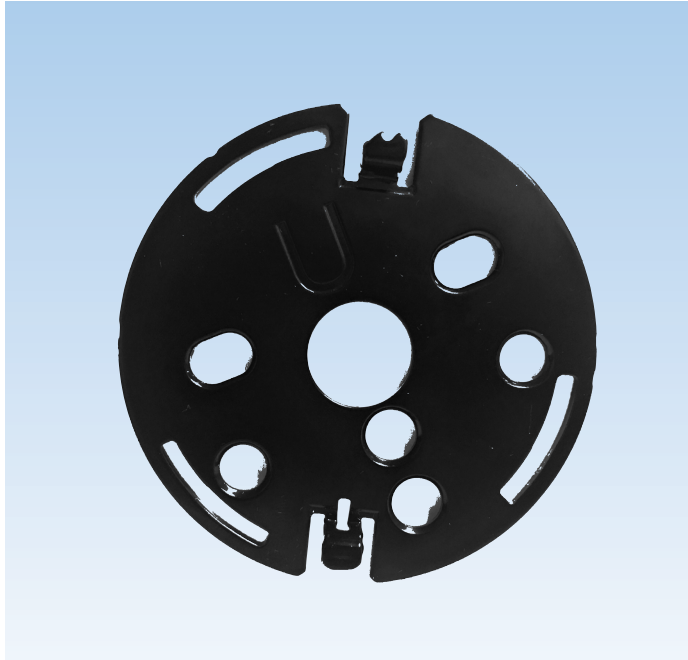

Danalock Accessories

Description	PU	Part Number
U Bracket	1	9-C0552-00-0-6

Additional information

- Replacement part for K-C0380-00-0-*



Danalock Accessories

Description	PU	Part Number
M4 button hex screws	4	9-C0967-04-0-8

Additional information

- Replacement part for K-C0380-00-0-*



Danalock Accessories

Description	PU	Part Number
Green Insert	1	9-C0558-00-0-0

Additional information

- Replacement part for K-C0380-00-0-*

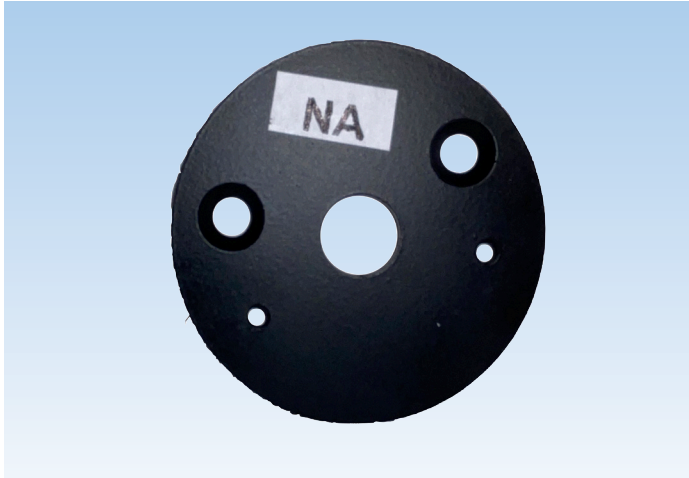

Danalock Accessories

Description	PU	Part Number
Black spacer NA	1	9-C0545-00-0-6

Additional information

- Replacement part for K-C0380-XX-0-*

Smart locks

for Door Lock



Smart lock

Description	PU	Part Number
Tedee PRO Smart Lock	1	6-C9370-00-0-*
PU = Packaging Unit		
1 = Silver, 6 = Black		



Additional information

- Rechargeable 3000 mAh LiPo battery (included)
- Bluetooth BLE 5.0 2,4 GHz (Tedee app) and Internet connection
- Security TLS 1.3
- Compatible with 55,65 mm plates and US rosettes



Tedee Smart lock remote access (Wi-Fi)

Description	PU	Part Number
Tedee Smart Bridge	1	6-C9382-00-0-7
PU = Packaging Unit		

Additional information

- Dimensions 63.5 x 63.5 x 28 mm / Weight 51.6g
- Power connection socket plug (included) or micro-USB (cable not included)
- Wi-Fi 2.4 GHz and 5.0 GHz
- Bluetooth 5.0 2.4 GHz
- Security TLS 1.3
- Compatible with Tedee smart lock 6-C9370-00-0-X and Bluetooth Keypad 6-C9387-00-0-6
- Works with smart home systems
- Up to 5 Smart Locks can be controlled (Bluetooth Range)



Bluetooth keypad

Description	PU	Part Number
Tedee Keypad	1	6-C9387-00-0-6
PU = Packaging Unit		

Additional information

- 3 X AAA batteries (included)
- Bluetooth 5.0 2,4 GHz
- Security TLS 1.3
- Up to 100 unique PINS
- Backlighted buttons, Sound signal, Bell button
- IP65 protection class
- Compatible with Tedee smart lock 6-9370-00-0-X and bridge 6-C9382-00-0-7

03
2



Micro USB Cable

Description	PU	Part Number
Micro USB Cable for TEDEE Lock	1	6-C9377-00-0-0
PU = Packaging Unit		

Strike Plates

for Door Lock

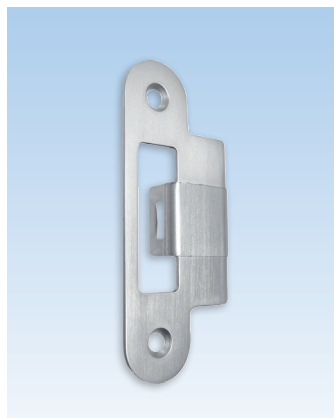

Top and Bottom Striker with Extended Lip

Description	PU	Part Number
Latchbolt strike plate for 45mm (1 3/4") thick doors	10	9-C4776-45-0-*
Latchbolt strike plate for 57mm (2 1/4") thick doors	10	9-C4776-57-0-*
* = Color		PU = Packaging Unit
03 = Polished Brass, 04 = Antique Brass, 5 = Dark Bronze, 6 = Black, 11 = Satin Nickel, 28 = Pewter		

Additional information

- Solid brass (03, 04, 28) or stainless steel (5, 6, 11)
- Non-handed
- With clear protective film
- Available in handle matching finishes
- Two #8 x 5/8 FH/PH screws included
- For use with GU-SECURY Automatic door lock



Middle Striker with Extended Lip

Description	PU	Part Number
Latch and deadbolt strike plate for 45mm (1 3/4") thick doors	10	9-C4777-45-0-*
Latch and deadbolt strike plate for 57mm (2 1/4") thick doors	10	9-C4777-57-0-*
* = Color		PU = Packaging Unit
03 = Polished Brass, 04 = Antique Brass, 5 = Dark Bronze, 6 = Black, 11 = Satin Nickel, 28 = Pewter		

Additional information

- Solid brass (03, 04, 28) or stainless steel (5, 6, 11)
- Non-handed
- With clear protective film
- Available in handle matching finishes
- Two #8 x 5/8 FH/PH screws included
- For use with GU-SECURY SH2, S-Bolt, Automatic and mortise door locks

Strike Plates

for Door Lock

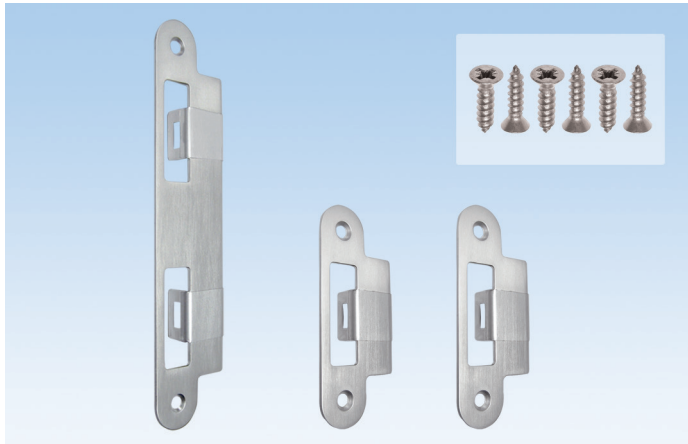

Bag of Strike Plates

Description	PU	Part Number
Bag of strike plates for 45mm (1 3/4") thick doors	50	K-C4774-45-0-*
Bag of strike plates for 57mm (2 1/4") thick doors	50	K-C4775-57-0-*
* = Color		PU = Packaging Unit
03 = Polished Brass, 04 = Antique Brass, 5 = Dark Bronze, 6 = Black, 11 = Satin Nickel, 28 = Pewter		

Additional information

- Solid brass (03, 04, 28) or stainless steel (5, 6, 11)
- Bag contains:
 - 1 middle striker with extended lip and clear protective film
 - 2 top and bottom strikers with extended lip and clear protective film
 - 6 screws
- Non-handed
- Available in handle matching finishes
- For use with GU-SECURY Automatic door locks

03
2

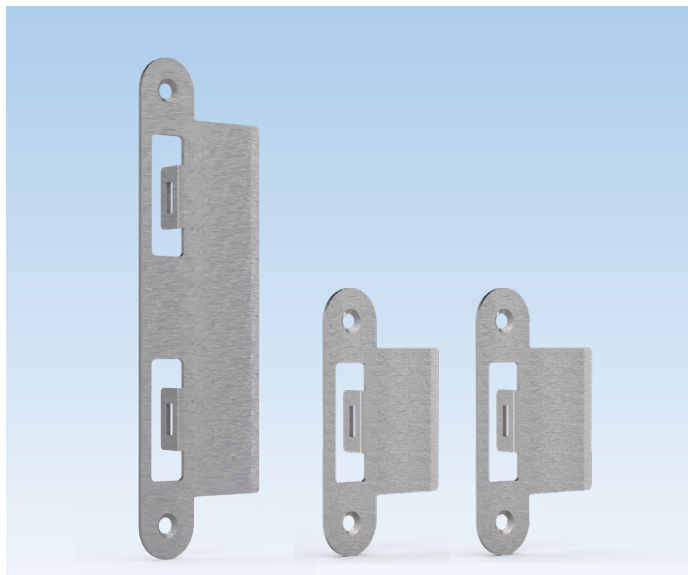

Bag of Strike Plates

Description	PU	Part Number
Bag of strike plates for 76mm (3") thick doors	1	K-C4777-59-0-*
* = Color		PU = Packaging Unit
8B = Stainless Steel, 6 = Black		

Additional information

- Made in stainless steel
- Bag contains:
 - 1 middle striker with extended lip
 - 2 top and bottom strikers with extended lip
- Non-handed
- For use with GU-SECURY Automatic door locks
- Six #8 x 5/8 FH/PH screws included

Strike Plates

for Door Lock

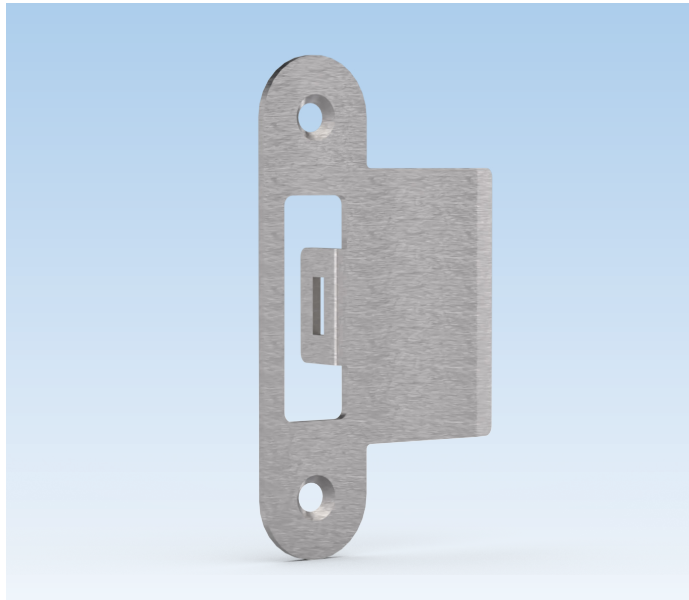

Top and Bottom Striker with Extended Lip

Description	PU	Part Number
Latchbolt strike plate for 76mm (3") thick doors	10	9-C4716-59-0-*

* = Color PU = Packaging Unit

8B = Stainless Steel, 6 = Black



Additional information

- Made in stainless steel
- Non-handed
- Two #8 x 5/8 FH/PH screws not included
- For use with GU-SECURITY Automatic door lock

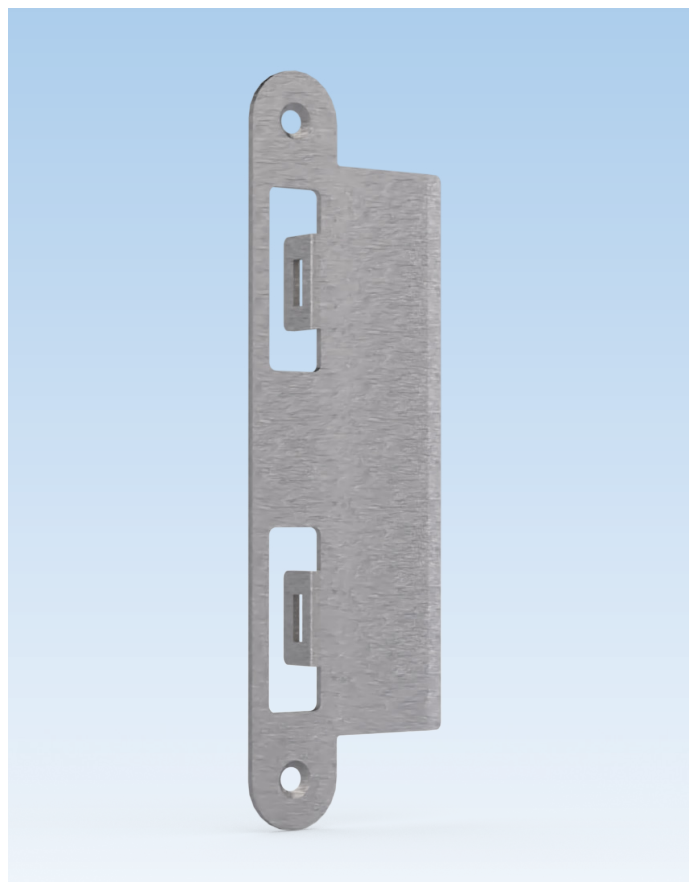

Middle Striker with Extended Lip

Description	PU	Part Number
Latch and deadbolt strike plate for 76mm (3") thick doors	10	9-C4717-59-0-*

* = Color PU = Packaging Unit

8B = Stainless Steel, 6 = Black



Additional information

- Made in stainless steel
- Non-handed
- Two #8 x 5/8 FH/PH screws not included
- For use with GU-SECURITY Automatic door lock



Torx 15 T-Key

Description	Color	PU	Part Number
Torx key	Steel	1	H-00346-15-0-0
PU = Packaging Unit			

Additional information

- Used for connecting SH2 and Automatic extensions



4mm Allen T-Key

Description	Color	PU	Part Number
Allen key	Steel	1	H-00345-04-0-0
PU = Packaging Unit			

Additional information

- Used for reversing Automatic latchbolts on GU-SECURY Automatic lock and extension



Fastening Screws

Description	Color	PU	Part Number
D1 screws	Stainless Steel	1000	9-C5362-32-0-8
PU = Packaging Unit			

Additional information

- Stainless steel lock fastening screws
- Type D1 with self-drilling spiral point and high duplex thread with "Quadrex" socket
- Sharp tip for quick drive

Accessories

for Lever Handle



Handle Set Color Chips

Description	PU	Part Number
Color chips	1	K-C4780-00-0-0

* = Color PU = Packaging Unit

01 = Satin Chrome, 03 = Polished Brass, 04 = Antique Brass, 05 = Oil Rubbed Bronze, 5 = Dark Bronze, 6 = Black, 7 = White, 11 = Satin Nickel, 25 = Dark Bronze, 28 = Pewter

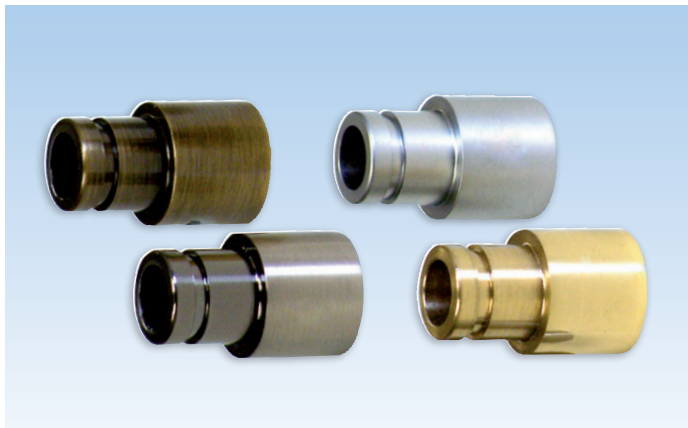

Handle Extenders

Description	PU	Part Number
Handle extenders	1	9-C0695-00-0-*

* = Color PU = Packaging Unit

01 = Satin Chrome, 03 = Polished Brass, 04 = Antique Brass, 05 = Oil Rubbed Bronze, 5 = Dark Bronze, 6 = Black, 25 = Dark Bronze, 28 = Pewter



Additional information

- Made of solid brass
- Use with our solid brass handle sets
- Extends 18mm

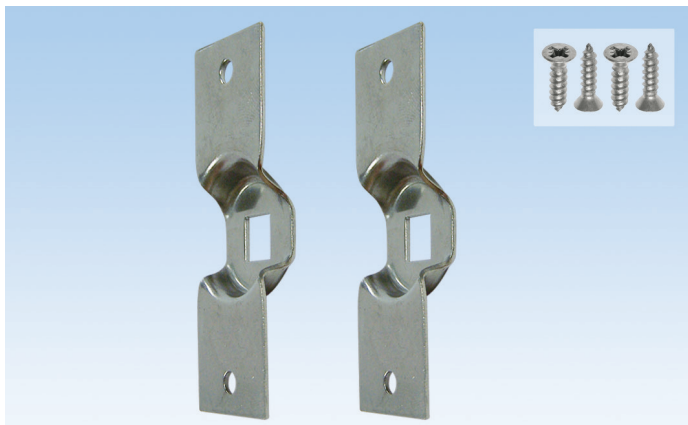

Fixing Plate for Dummy Trim Kits

Description	PU	Part Number
Fixing plate used for fixed door handle	50	9-U8210-00-0-3

PU = Packaging Unit

Additional information

- Made of zinc plated steel
- Bag of two dummy plates and four #6 x 5/8" FH/PH screws
- Included with Handle Dummy kits
- Part not required for Active & Semi-Active handles
- Fixing in the door

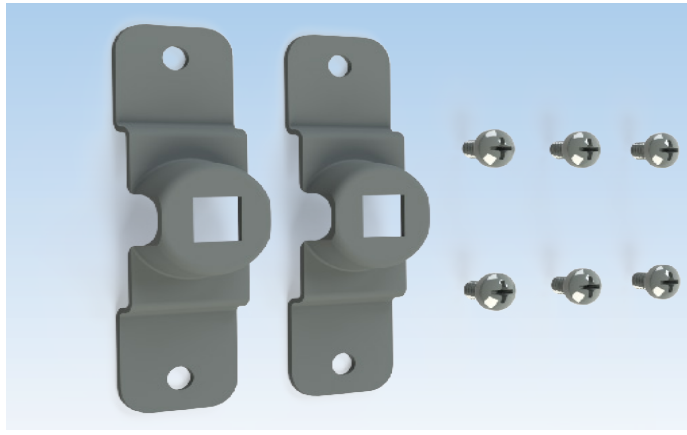

Fixing Plate for Dummy Trim Kits with 55 and 65mm plate

Description	PU	Part Number
Fixing Plate for Dummy trim kits	1	K-C0973-00-0-0
PU = Packaging Unit		

Additional information

- Made of Zinc plated steel
- Bag of two dummy plates and six #6 x 5/8" FH/PH screws
- Included with 55 and 65mm plate Handle Dummy Kits
- Part not required for active and semi-active handles
- Fixing in the plate

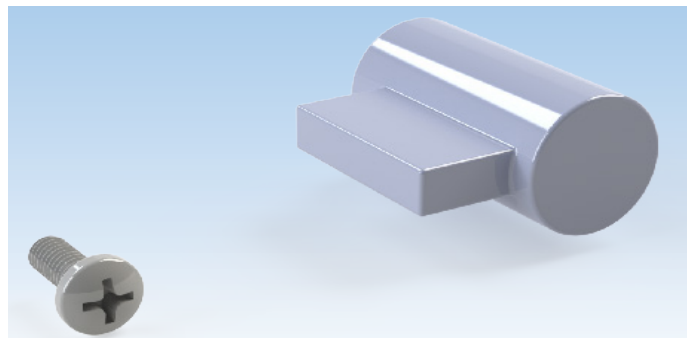

Dummy conversion kit

Description	PU	Part Number
Dummy conversion kit	1	K-C0971-00-0-*
* = Color		PU = Packaging Unit

11 = Satin Nickel, 25 = Dark Bronze



Additional information

- Made of Brass
- Bag of one dummy cylinder and one M4 x 10mm FH/PH screws
- Pre-installed with dummy and semi-active handles with 65mm plate
- Part not required for active handles

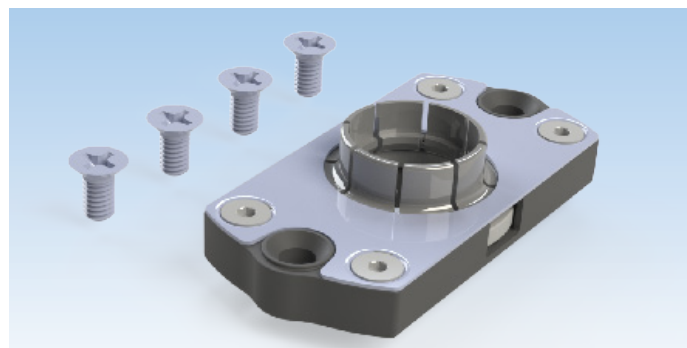

Replacement Snap & Turn box

Description	PU	Part Number
Snap & Turn Box	1	K-C2057-00-0-0
PU = Packaging Unit		

Additional information

- Bag of one box and four M4 x 8mm FH/PH screws
- Included with handle sets with 65mm plate

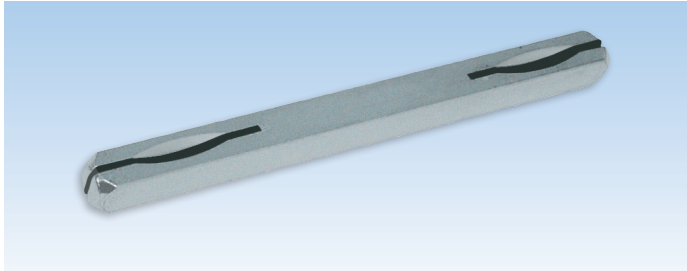

8mm Spindle			
Description		PU	Part Number
8 x 8 x 120mm spindle for 41-57mm thick doors <i>(1 spindle is supplied with door handle kit)</i>	Zinc	10	9-U8100-20-0-8
8 x 8 x 130mm spindle for 57-76mm thick doors	Zinc	10	9-U8100-30-0-8
PU = Packaging Unit			

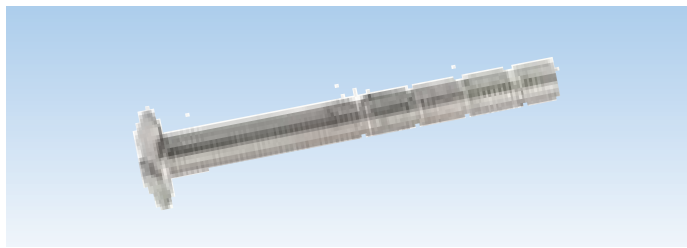

① For 41-76 mm thick doors

Re-cuttable M5 Screw			
Description		PU	Part Number
① M5 x 90mm screws <i>(2 screws are supplied with door handle kit)</i>		1	9-U2510-90-R-*
* = Color		PU = Packaging Unit	
01 = Satin Chrome, 03 = Polished Brass, 04 = Antique Brass, 05 = Oil Rubbed Bronze, 5 = Dark Bronze, 6 = Black, 7 = White, 11 = Satin Nickel, 25 = Dark Bronze, 28 = Pewter			

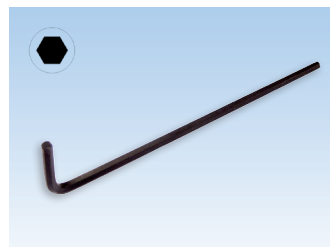

Set Screw & Allen Key			
Description	Color	PU	Part Number
M5 set screw <i>(2 screws are included with door handle kit)</i>	Stainless Steel	1	9-U6008-05-0-1
Allen key 2.5 x 20 x 100mm <i>(1 Allen key is supplied with door handle kit)</i>	Black	1	9-C0955-10-0-0
PU = Packaging Unit			



Knob Tail Replacement Kits			
Description	Color	PU	Part Number
48mm knob tail with snap rings	Black	1	K-C0600-48-0-0
72mm recutable knob tail with snap rings	Black	1	K-C0600-72-0-0
PU = Packaging Unit			

Additional information

- Knob tail made of tempered steel
- Used for semi-active handle trim kits
- 48 mm for doors from 1 3/4" to 2 3/4"
- 72mm recutable for doors from 2 3/4" to 3 5/8"

Accessories

for Lever Handle



Snap Rings

Description	Color	PU	Part Number
Snap ring	Black	1	9-C0645-02-0-6A
Snap ring – low profile	Black	1	9-C0645-03-0-6

PU = Packaging Unit



Washers

Description	Color	PU	Part Number
Nylatron washer 0.25mm x 16mm (inner dia.)	Clear	1	9-C0647-25-0-0
Nylatron washer 0.5mm x 16mm (inner dia.)	Clear	1	9-C0647-50-0-0
Nylatron washer 1.0mm x 16mm (inner dia.)	Clear	1	9-C0647-10-0-0

* = Color PU = Packaging Unit



“O” Ring

Description	Color	PU	Part Number
“O” ring 1.5mm x 16mm (inner dia.)	Black	1	9-C0953-00-0-6

PU = Packaging Unit



Cylinders Schlage “C” Keyway

Description	Color	PU	Part Number
① Cylinder with 52mm tail and set of three keys	Zinc	1	6-C0971-52-0-1
	Brass	1	6-C0971-52-0-3
	Dark Bronze	1	6-C0971-52-0-25
② Cylinder with 64mm tail and set of three keys	Zinc	1	6-C0971-64-0-1
	Dark Bronze	1	6-C0971-64-0-25
③ Cylinder with 90 mm tail and set of three keys	Zinc	1	6-C0971-90-0-1
	Brass	1	6-C0971-90-0-3
	Dark Bronze	1	6-C0971-90-0-25

PU = Packaging Unit

- ① For 41-57 mm thick doors with plate 30,45,55mm
- ② For 41-57 mm thick doors with plate 65mm
- ③ For 41-76 mm thick doors

Key Alike Cylinders Schlage “C” Keyway

Description	Color	PU	Part Number
① Cylinder with 52mm tail and set of three keys	Zinc	1	6-C0971-52-9-1
	Brass	1	6-C0971-52-9-3
	Dark Bronze	1	6-C0971-52-9-25
② Cylinder with 64mm tail and set of three keys	Zinc	1	6-C0971-64-9-1
	Dark Bronze	1	6-C0971-64-9-25
③ Cylinder with 90mm tail and set of three keys	Zinc	1	6-C0971-90-9-1
	Brass	1	6-C0971-90-9-3
	Dark Bronze	1	6-C0971-90-9-25

PU = Packaging Unit

Accessories

for Lever Handle

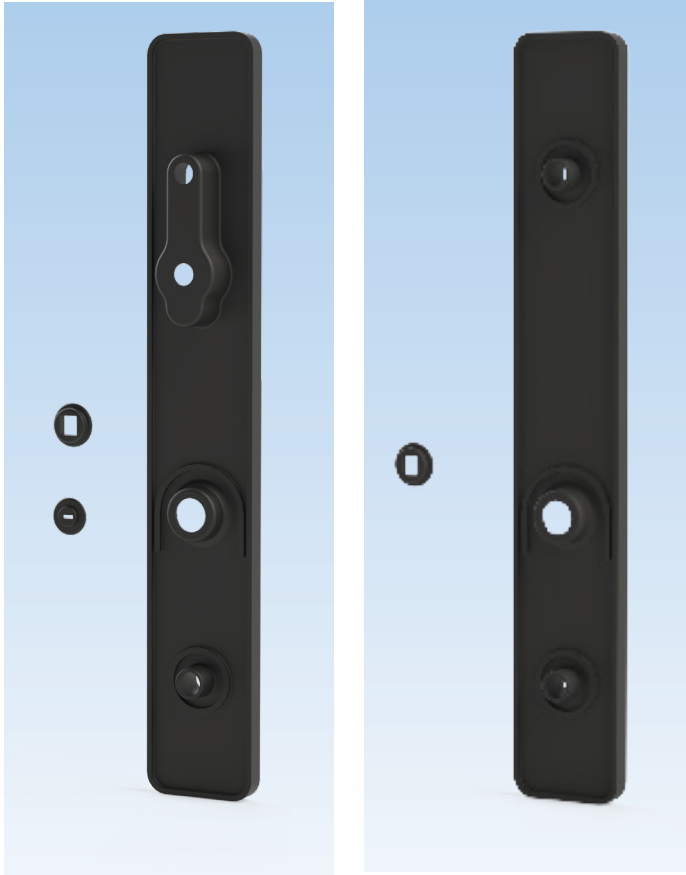

Gasket 55mm

Description	Color	PU	Part Number
Gasket for active plate	Black	1	6-C0825-55-0-6
Gasket for inactive plate	Black	1	6-C0826-55-0-6
PU = Packaging Unit			

Additional information

- Not compatible with Dummy Handle fixing Plates K-C0973-00-0-0. To use this product in a dummy handle configuration, use fixing plates 6-C0800-03-0-0

Accessories

for Lever Handle

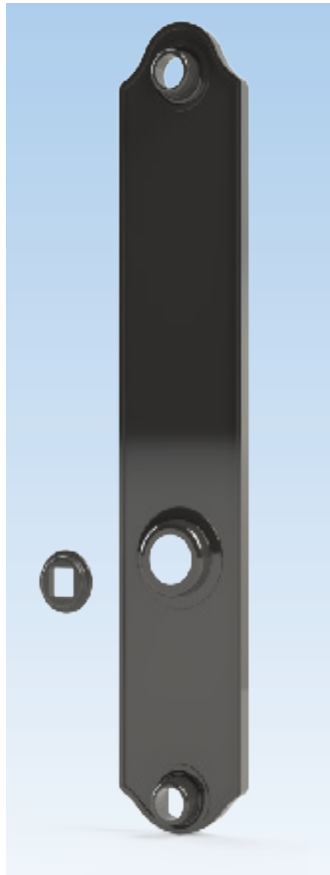

Gasket 45mm

Description	Color	PU	Part Number
Gasket for active plate	Black	1	6-C0825-00-0-6
Gasket for inactive plate	Black	1	6-C0826-00-0-6
PU = Packaging Unit			

Accessories for Strike Plate



Dust Cup Edge– 25mm

Description	Color	PU	Part Number
Plastic cup	Black	10	9-C4765-00-0-6
		100	9-C4765-1C-0-6
		500	9-C4765-5C-0-6

PU = Packaging Unit

Additional information

- Use for latch and 2 automatic latches (optional)
- Dimensions:
 - Length: 62mm
 - Width: 19.5mm
 - Depth: 25.8mm



Dust Cup without Edge – 15mm

Description	Color	PU	Part Number
Plastic cup	Black	10	9-C4765-0A-0-6
		100	9-C4765-1C-A-6
		500	9-C4765-5C-A-6

PU = Packaging Unit

Additional information

- Dimensions:
 - Length: 62mm
 - Width: 19.5mm
 - Depth: 16mm



Screws for Strike Plates

Description	PU	Part Number
#8 x 5/8" (16mm) screws	10	K-C4763-16-6-*

* = Color

PU = Packaging Unit

03 = Polished Brass, 04 = Antique Brass, 5 = Dark Bronze, 6 = Black, 11 = Satin Nickel, 28 = Pewter

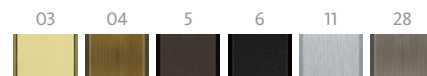

Additional information

- Bag of 6 screws for strike plates
- #8 x 5/8" FH/PH screws



Construction Handle Set

Description	Color	PU	Part Number
Construction handle	Black	25	K-C9250-25-0-6
PU = Packaging Unit			

Additional information

- Reinforced nylon temporary door trim sets
- 8 x 8 x 90mm square spindle included
- 4.2 x 50mm screws included
- For 1 3/4" thick doors
- Locking/Unlocking from inside only



Construction Key

Description	Color	PU	Part Number
Construction key	Black	10	9-U0001-01-0-0
PU = Packaging Unit			

Additional information

The construction key is available for those who prefer to install the decorative hardware trim and lever sets on doors after the construction has been completed. Installing the escutcheon plates and levers in the final stage of construction prevents the decorative trim from becoming scratched or damaged.

The construction key has been designed to accommodate multipoint door hardware (8mm square), tilt-turn hardware (7mm square) and lift-slide hardware (10mm square).

Handle Display

for Lever Handle



Handle Display with Lever Handles

Description	PU	Part Number
Handle display	1	6-C9618-00-0-9

* = Color PU = Packaging Unit

01 = Satin Chrome, 03 = Polished Brass, 04 = Antique Brass, 05 = Oil Rubbed Bronze, 5 = Dark Bronze, 6 = Black, 7 = White, 11 = Satin Nickel, 25 = Dark Bronze, 28 = Pewter



Additional information

- To be used with 30, 45 and 55mm escutcheons and Capri, Torino, Allegro, Venice or Roma handles
- When ordering, please pick handle, plate and finish
- 7" x 7" x 17" 1/4 (17.75 cm x 17.75 cm x 44 cm)

Handle Display

for Lever Handle and Door Lock



Handle Display with Door Lock and Handle

Description	PU	Part Number
Handle display - 45mm (1 3/4") thick	1	K-C9615-00-0-9
Handle display - Smart Lock	1	K-C9619-SL-0-9
Handle display - Smart Lock Tedee	1	K-C9619-SL-T-9
PU = Packaging Unit		



Additional information

- Handle complete with lever handle and SECURY Automatic sample gear
- To be used with 30, 45 and 55mm escutcheons and Capri, Torino, Allegro, Venice or Roma handle
- Roma handle with Danalock smart lock with K-C9619-SL-0-9
- Roma handle with Tedee smart lock with K-C9619-SL-T-9
- When ordering, please add note for escutcheon, handle, and finish

03
2



Handle Display with US Rosette

Description	PU	Part Number
Handle display - 45mm (1 3/4") thick	1	K-C9622-00-0-9
Handle display - Danalock Smart Lock	1	K-C9621-SL-0-9
Handle display - Tedee Smart Lock	1	K-C9621-SL-T-9
PU = Packaging Unit		

Additional information

- Handle complete with lever handle and SECURY Automatic sample gear
- To be used with US Rosette and Belcanto Handles
- US Rosette with Danalock smart lock with K-C9621-SL-0-9
- US Rosette with Tedee smart lock with K-C9621-SL-T-9
- When ordering, please add note for finish



Handle Display

for Lever Handle and Door Lock

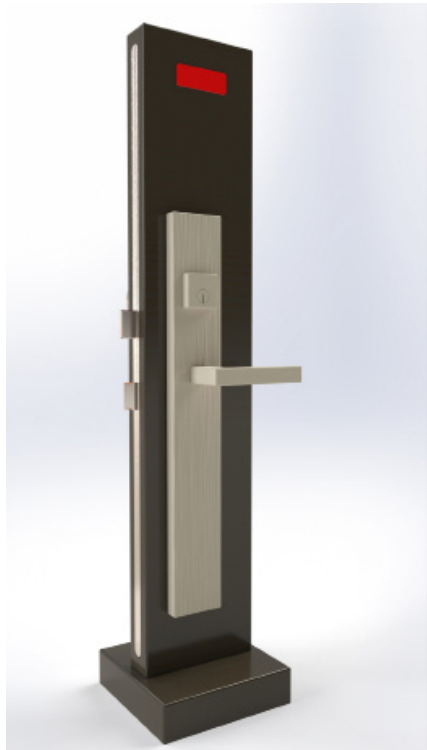

Handle Display with Door Lock and Handle

Description	PU	Part Number
Handle display – 65mm Plate	1	K-C9642-00-0-9
Handle display – 65 mm Plate with Danalock Smart Lock	1	K-C9642-SL-0-9
Handle display – 65 mm Plate with Tedee Smart Lock	1	K-C9642-SL-T-9
PU = Packaging Unit		

Additional information

- Handle complete with lever handle and SECURITY Automatic sample gear
- 65 mm plate with Tedee smart lock K-C9642-SL-T-9
- When ordering, please add note for finish



Handles Display with Lever Handles

Description	PU	Part Number
ROMA 55	1	K-C9608-A0-0-7
CAPRI	1	K-C9608-A2-0-7
TORINO 30	1	K-C9608-A4-0-7
BERLIN 65	1	K-C9608-A5-0-7
VENISE 45	1	K-C9608-A6-0-7
ALLEGRO 30	1	K-C9608-A8-0-7
Display Base	1	6-C9602-00-0-6
PU = Packaging Unit		

* Models in this table are also available in French.

- Display delivered with wall mounted kit
- The display base is an option to place the unit on a desk, to be ordered separately
- 21"1/2 x 32" x 12" (53.2 cm x 80.25 cm x 30.5 cm)



WINDOW TECHNOLOGY
DOOR TECHNOLOGY
AUTOMATIC ENTRANCE SYSTEMS
BUILDING MANAGEMENT SYSTEMS

QUÉBEC / MARITIMES

Ferco Ferrures de Bâtiment Inc.
2000, Rue Berlier
Laval, QC H7L 4S4
Canada

T 450 973-1437
1 800 355-8810
F 450 973-7661
ferco@ferco.ca

ONTARIO / WESTERN PROVINCES

Ferco Architectural Hardware Inc.
T 905 282-9588
1 800 668-5310
F 905 282-9915

UNITED STATES

Ferco Architectural Hardware Inc.
T 1 800 927-1097
F 1 888 454-0161

www.ferco.ca

Securing technology for you

