



WINDOW TECHNOLOGY
DOOR TECHNOLOGY
AUTOMATIC ENTRANCE SYSTEMS
BUILDING MANAGEMENT SYSTEMS



DOOR TECHNOLOGY – ORDER CATALOG | SECTION 03.2



SECURY Automatic Door Lock & Lever Handle



Securing technology for you





03.2

SECURY Automatic Door Lock & Lever Handle

GEARS

| | |
|----------------------------------|--------|
| SECURY Automatic Door Lock | 03.2.3 |
| Automatic Extension | 03.2.4 |
| Filler Pieces | 03.2.5 |
| Mortise Door Lock | 03.2.6 |

HANDLES

| | |
|---------------------------------------|--------|
| Introduction | 03.2.7 |
| Finishes for handle set program | 03.2.8 |

30mm Plate Series

| | |
|-------------------------|---------|
| ALLEGRO Trim Kits | 03.2.10 |
| TORINO Trim Kits | 03.2.11 |
| VENICE Trim Kits | 03.2.12 |

45mm Plate Series

| | |
|------------------------|---------|
| CAPRI Trim Kits | 03.2.13 |
| TORINO Trim Kits | 03.2.14 |
| VENICE Trim Kits | 03.2.15 |

55mm Plate Series

| | |
|----------------------|---------|
| ROMA Trim Kits | 03.2.16 |
|----------------------|---------|

65mm Plate Series & BELCANTO Handle

| | |
|--|---------|
| BERLIN Trim Kits | 03.2.17 |
| BERLIN Trim Kits | 03.2.18 |
| BELCANTO & VENTO Handle & US Rosette | 03.2.19 |

ACCESSORIES

| | |
|-----------------------|---------|
| Smart locks | 03.2.21 |
| Strike Plates | 03.2.24 |
| Accessories | 03.2.25 |
| Handle Displays | 03.2.34 |

SECURY Automatic Door Lock

for lever handle with North American Cylinder



Unlocked



Locked

USE WITH LEVER HANDLES ONLY

SECURY Automatic Door Lock for Lever Handle

| Description | Backset | Color | PU | Part Number |
|---------------------------|---------|-------|----|-----------------|
| Door lock for 6' 8" doors | 45mm | SS | 5 | 6-35856-01-R-8B |
| Door lock for 8' doors | 45mm | SS | 5 | 6-35856-02-R-8B |
| Door lock for 6' 8" doors | 50mm | SS | 5 | 6-36033-01-R-8B |
| Door lock for 8' doors | 50mm | SS | 5 | 6-36033-02-R-8B |
| Door lock for 6' 8" doors | 60mm | SS | 5 | 6-35565-01-R-8B |
| Door lock for 8' doors | 60mm | SS | 5 | 6-35565-02-R-8B |
| Door lock for 6' 8" doors | 70mm | SS | 5 | 6-35565-05-R-8B |
| Door lock for 8' doors | 70mm | SS | 5 | 6-35565-06-R-8B |

PU = Packaging Unit

Simply Close the Door!

As soon as the door pulled shut, the Automatic latchbolts instantly throw 20mm and are secured to prevent them being forced back. By turning the key or the knob, the center deadbolt will engage and lock the top and bottom latchbolts to become a **3-deadbolt locking system**.

Additional information

- 3-point, one piece locking system for 6' 8" and 8' doors
- Heavy duty mortise construction with reinforced lever return spring system
- Locking by US-cylinder with 90° turn of key or thumb-turn
- No lifting of handle to engage locking points
- Top and bottom Automatic latchbolt projection from 10 to 20mm:
 - Provides security
 - Protects the door
- 1" (25mm) throw on deadbolt with baby sitting function
- Non handed, latch easily reversible
- 8mm square spindle
- 92mm centres (spindle to cylinder)
- Handle height variable (36" recommended)
- 16mm stainless steel faceplate with radius ends for easy installation and cleaner look
- Same hardware groove detail throughout our entire door lock program (jig, router base and bits available)
- Various extension with additional lock point is available for doors taller than 8'
- To be used with lever handle set (US-cylinder above handle)

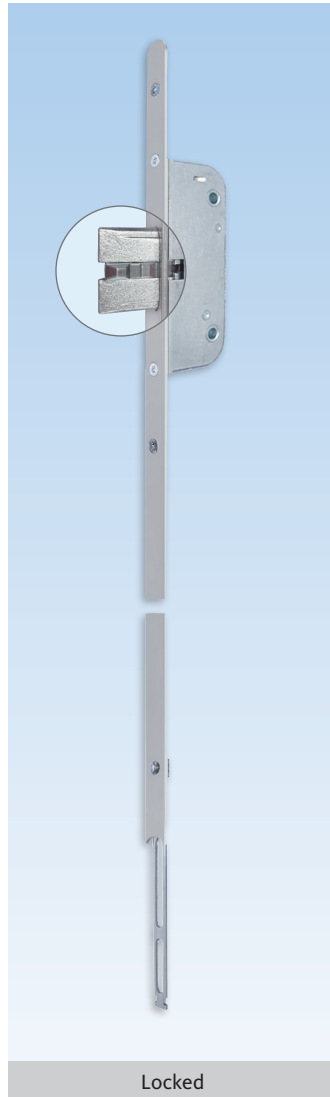
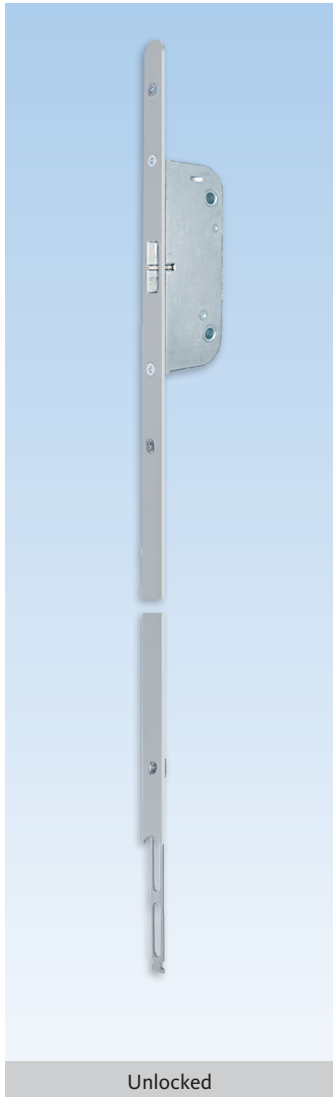

Extension with Additional Latchbolt

| Description | Color | PU | Part Number |
|-----------------------------------|-----------------|---------------------|-----------------|
| 525mm extension with rounded end | Stainless Steel | 5 | 6-33479-04-0-8B |
| 800mm extension with rounded end | Stainless Steel | 1 | 6-C5078-00-0-8B |
| 1050mm extension with rounded end | Stainless Steel | 1 | 6-C5062-10-0-8B |
| 1325mm extension with rounded end | Stainless Steel | 1 | 6-C5062-13-0-8B |
| * = Color | | PU = Packaging Unit | |

Additional information

- Tapered latch always engaging in strike plate
- 16mm stainless steel faceplate with radius end for easy installation and cleaner look
- Additional locking point for doors taller than 8'
- To be used with GU-SECURY Automatic door Locks

Filler pieces

Round to square



Filler Pieces

| Description | PU | Part Number |
|----------------------|----|-----------------|
| Filler piece 193,7mm | 1 | 9-C4340-19-0-8B |
| Filler piece 245,9mm | 1 | 9-C4342-24-0-8B |
| Filler piece 342,3mm | 1 | 9-C4342-34-0-8B |

Additional information

- Made of stainless steel
- To be used with radius end locks and extensions

Formulas to select filler length:

- Bottom:
L = Handle height - 671,7mm
- Top 1590mm lock:
L = Door height - handle height - extension(s) length - 920,7mm
- Top 1900mm lock:
L = Door height - handle height - extension(s) length - 1230,7mm

Mortise Door Lock

with Latch and Deadbolt



Mortise Door Lock for Lever Handle

| Description | Color | PU | Part Number |
|-----------------------------|-----------------|---------------------|-----------------|
| Door lock with 45mm backset | Stainless Steel | 10 | 6-C4893-45-0-8B |
| Door lock with 50mm backset | Stainless Steel | 10 | 6-C4893-50-0-8B |
| Door lock with 60mm backset | Stainless Steel | 10 | 6-C4893-60-0-8B |
| Door lock with 70mm backset | Stainless Steel | 10 | 6-C4893-70-0-8B |
| * = Color | | PU = Packaging Unit | |

Additional information

- Heavy duty mortise construction with reinforced lever return spring system
- Locking by US-cylinder with 90° turn of key or thumb-turn to engage the 1" (25mm) deadbolt
- Non-handed, latch easily reversible
- 8mm square spindle
- 92mm centres (spindle to cylinder)
- 16mm stainless steel faceplate with radius ends for easy installation and cleaner look
- Same hardware groove detail throughout our entire door lock program (jig, router base and bits available)
- Ideal for exterior and interior door applications
- To be used with lever handle set (US-cylinder above handle)



Ferco lever handle sets are uniquely designed to operate on multipoint door locks. Our handle sets withstand the rigorous everyday operational wear & tear of engaging or disengaging multiple lock points. **Our handle sets are designed for long term use!**

- **Patented handle snap-rings** allow for handles to be shipped non-handed. The manufacturer no longer has to worry about ordering left or right, and will save on inventory.
- **Handle setscrews to fasten spindles** combined with the snap-ring will ensure the handle will stay tight on the door for a long time.
- **Self centering 8mm split Spindle** to make sure it is always centered into the door.
- **Longer Screw ports on escutcheons:** Ferco has added an interior sleeve port that will guide the M5 mm screw straight to the opposing exterior screw port.
- **Exterior O-ring on handle shaft** to prevent water from entering around the exterior handle.
- **Washers between handle and escutcheon** making sure the handle operation is and remains smooth.
- **Escutcheon Foam gasket** to prevent air and cold.
- **Rubber gasket** (Order separately) to prevent air and water leakage around the exterior escutcheon.
- **Schlage Cylinder with one tail for both 1 ¾” and 2 ¼” thick doors**
- **M5 handle set screws to fasten the escutcheons** included in every handle set kit.
- **Handle above cylinder or handle below cylinder option**
- **FERCO handle sets available** in Solid Brass or economical zinc die-cast material with selections in many plate designs, lever styles and finishes.

Finishes For Handle Set Program

- US-Cylinder Above Handle



| | SOLID BRASS | | | | | | ZAMAC | | | | | |
|-------------------|--|--|--|--|--|--|--|--|--|--|--|--|
| | 45mm PLATE | | | 30mm PLATE | | | 45mm PLATE | | | 30mm PLATE | | |
| | | | | | | | | | | | | |
| | K-U6292-01 K-U6246-00 K-U6210-00 | K-U6492-01 K-U6446-00 K-U6410-00 | K-U6692-01 K-U6646-00 K-U6610-00 | K-U3192-01 K-U3146-00 K-U3110-00 | K-U3492-01 K-U3446-00 K-U3410-00 | K-U3692-01 K-U3646-00 K-U3610-00 | K-U7292-Z1 K-U7246-Z0 K-U7210-Z0 | K-U7492-Z1 K-U7446-Z0 K-U7410-Z0 | K-U7692-Z1 K-U7646-Z0 K-U7610-Z0 | K-U5192-Z1 K-U5146-Z0 K-U5110-Z0 | K-U5492-Z1 K-U5446-Z0 K-U5410-Z0 | K-U5692-Z1 K-U5646-Z0 K-U5610-Z0 |
| | 01 | 01 | 01 | 01 | 01 | 01 | | 01 | 01 | 01 | 01 | 01 |
| Satin Chrome | | | | | | | | | | | | |
| | 03 | 03 | 03 | 03 | 03 | 03 | | | | | | |
| Polished Brass | | | | | | | | | | | | |
| | 04 | 04 | 04 | 04 | 04 | 04 | | | | | | |
| Antique Brass | | | | | | | | | | | | |
| | 05 | 05 | 05 | 05 | 05 | 05 | | | | | | |
| Oil Rubbed Bronze | | | | | | | | | | | | |
| | | | | | | | 5 | 5 | 5 | 5 | 5 | 5 |
| Dark Bronze PC | | | | | | | | | | | | |
| | | | | | | | 6 | 6 | 6 | 6 | 6 | 6 |
| Black PC | | | | | | | | | | | | |
| | | | | | | | | | | | | |
| White PC | | | | | | | | | | | | |
| | 11 | 11 | 11 | 11 | 11 | 11 | | | | | | |
| Satin Nickel | | | | | | | | | | | | |
| | | | | | | | | | | | | |
| Dark Bronze | | | | | | | | | | | | |
| | 28 | 28 | 28 | 28 | 28 | 28 | | 28 | 28 | 28 | 28 | 28 |
| Pewter | | | | | | | | | | | | |

Colors on this document are graphic representation and may not be an exact match for the actual painted/plated hardware.
For color selection, material samples are available on request.

Finishes For Handle Set Program

- US-Cylinder Above Handle



| | SOLID BRASS 55mm PLATE | ZAMAC 55mm PLATE | SOLID BRASS 65mm PLATE | ZAMAC 65mm PLATE |
|-------------------|---|---|---|---|
| | ROMA K-U4092-01 K-U4046-00 K-U4010-00 | ROMA K-U9092-Z1 K-U9046-Z0 K-U9010-Z0 | BERLIN K-U2592-Z1 K-U2546-Z0 K-U2510-Z0 | BERLIN K-U8592-Z1 K-U8546-Z0 K-U8510-Z0 |
| Satin Chrome | | | | |
| Polished Brass | | | | |
| Antique Brass | | | | |
| Oil Rubbed Bronze | | | | |
| Dark Bronze PC | | 5 | | 5 |
| Black PC | | 6 | | 6 |
| White PC | | | | |
| Satin Nickel | 11 | | 11 | |
| Dark Bronze | | | | |
| Pewter | 28 | | 28 | |

03
2

Colors on this document are graphic representation and may not be an exact match for the actual painted/plated hardware.
 For color selection, material samples are available on request.

ALLEGRO Handles & 30mm Plates



ALLEGRO Solid brass Trim Kits

| Description | PU | Part Number |
|--|----|---------------------|
| Handle sets for active doors with US-cylinder | 1 | K-U3192-01-0-* |
| Handle sets for semi-active doors | 1 | K-U3146-00-0-* |
| Handle sets for fixed doors | 1 | K-U3110-00-0-* |
| Handle sets for TEDEE Smart Lock | 1 | K-U3192-T1-0-* |
| * = Color | | PU = Packaging Unit |
| 01 = Satin Chrome, 03 = Polished Brass, 04 = Antique Brass, 05 = Oil Rubbed Bronze, 11 = Satin Nickel, 28 = Pewter | | |

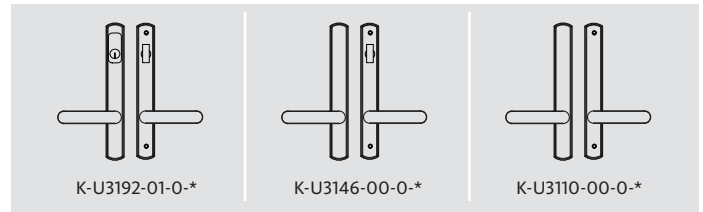
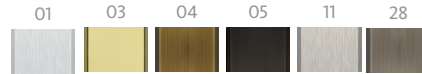

Additional information

- Unassembled solid brass trim kits
- US-cylinder with standard 5 pins Schlage "C" keyway
- 90° locking with thumb-turn
- Self-centering 8mm spindle

- Stainless steel set screw on levers to secure spindle
- Patented handle clipping system
- Kit for 1 3/4" and 2 1/4" thick doors
- US-cylinder above handle
- Compatible with TEDEE smart locks



ALLEGRO Zamac Trim Kits

| Description | PU | Part Number |
|--|----|---------------------|
| Handle sets for active doors with US-cylinder | 1 | K-U5192-Z1-0-* |
| Handle sets for semi-active doors | 1 | K-U5146-Z0-0-* |
| Handle sets for fixed doors | 1 | K-U5110-Z0-0-* |
| Handle sets for TEDEE Smart Lock | 1 | K-U5192-T1-0-* |
| * = Color | | PU = Packaging Unit |
| 01 = Satin Chrome, 5 = Dark Bronze PC, 6 = Black PC, 28 = Pewter | | |

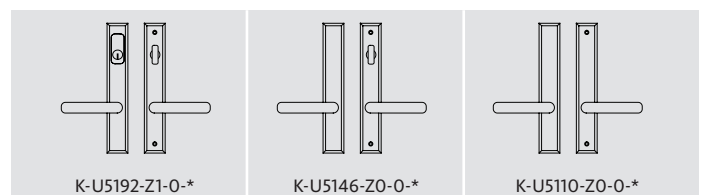
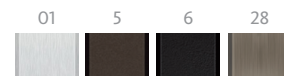

Additional information

- Unassembled zamac trim kits
- US-cylinder with standard 5 pins Schlage "C" keyway
- 90° locking with thumb-turn
- Self-centering 8mm spindle

- Stainless steel set screw on levers to secure spindle
- Patented handle clipping system
- Kit for 1 3/4" and 2 1/4" thick doors
- US-cylinder above handle
- Compatible with TEDEE smart locks

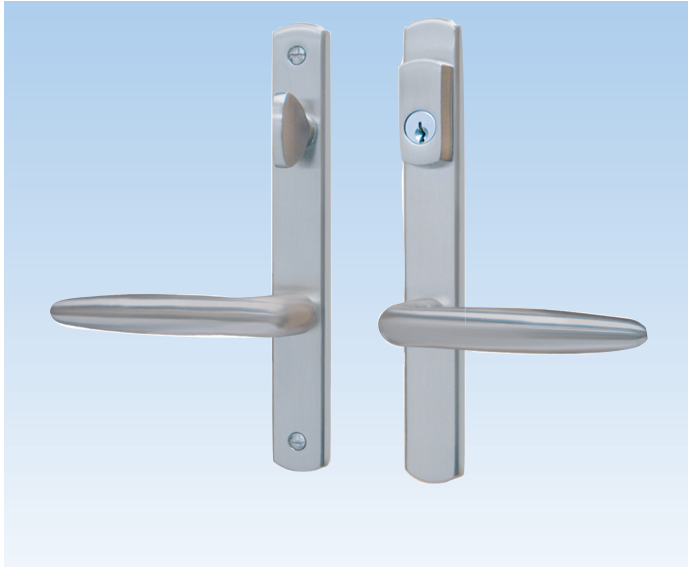

Additional information

- Unassembled solid brass trim kits
- US-cylinder with standard 5 pins Schlage "C" keyway
- 90° locking with thumb-turn
- Self-centering 8mm spindle



Additional information

- Unassembled zamac trim kits
- US-cylinder with standard 5 pins Schlage "C" keyway
- 90° locking with thumb-turn
- Self-centering 8mm spindle

TORINO Solid brass Trim Kits

| Description | PU | Part Number |
|---|----|----------------|
| Handle sets for active doors with US-cylinder | 1 | K-U3492-01-0-* |
| Handle sets for semi-active doors | 1 | K-U3446-00-0-* |
| Handle sets for fixed doors | 1 | K-U3410-00-0-* |
| Handle sets for TEDEE Smart Lock | 1 | K-U3492-T1-0-* |

* = Color PU = Packaging Unit

01 = Satin Chrome, 03 = Polished Brass, 04 = Antique Brass,
05 = Oil Rubbed Bronze, 11 = Satin Nickel, 28 = Pewter

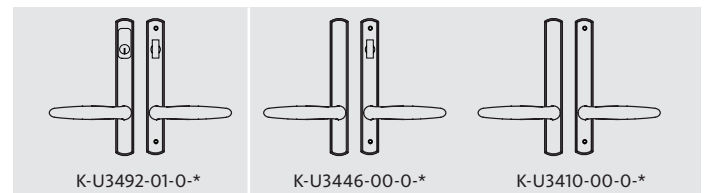
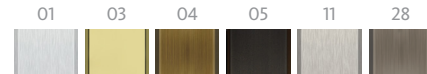

- Stainless steel set screw on levers to secure spindle
- Patented handle clipping system
- Kit for 1 3/4" and 2 1/4" thick doors
- US-cylinder above handle
- Compatible with TEDEE smart locks

TORINO Zamac Trim Kits

| Description | PU | Part Number |
|---|----|----------------|
| Handle sets for active doors with US-cylinder | 1 | K-U5492-Z1-0-* |
| Handle sets for semi-active doors | 1 | K-U5446-Z0-0-* |
| Handle sets for fixed doors | 1 | K-U5410-Z0-0-* |
| Handle sets for TEDEE Smart Lock | 1 | K-U5492-T1-0-* |

* = Color PU = Packaging Unit

01 = Satin Chrome, 5 = Dark Bronze PC, 6 = Black PC, 28 = Pewter

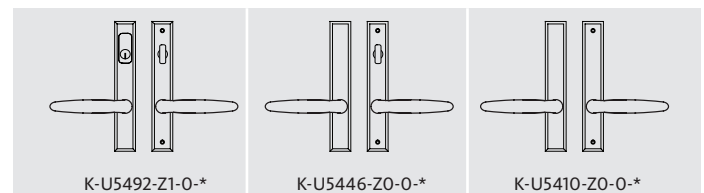
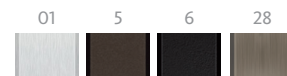

- Stainless steel set screw on levers to secure spindle
- Patented handle clipping system
- Kit for 1 3/4" and 2 1/4" thick doors
- US-cylinder above handle
- Compatible with TEDEE smart locks

VENICE Handle & 30mm Plate



VENICE Solid Brass Trim Kits

| Description | PU | Part Number |
|--|----|---------------------|
| Handle sets for active doors with US-cylinder | 1 | K-U3692-01-0-* |
| Handle sets for semi-active doors | 1 | K-U3646-00-0-* |
| Handle sets for fixed doors | 1 | K-U3610-00-0-* |
| Handle sets for TEDEE Smart Lock | 1 | K-U3692-T1-0-* |
| * = Color | | PU = Packaging Unit |
| 01 = Satin Chrome, 03 = Polished Brass, 04 = Antique Brass, 05 = Oil Rubbed Bronze, 11 = Satin Nickel, 28 = Pewter | | |

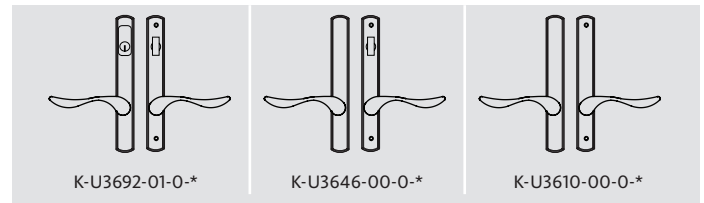
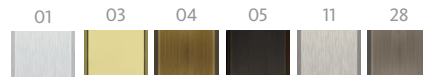

Additional information

- Unassembled solid brass trim kits
- US-cylinder with standard 5 pins Schlage "C" keyway
- 90° locking with thumb-turn
- Self-centering 8mm spindle

- Stainless steel set screw on levers to secure spindle
- Patented handle clipping system
- Kit for 1 3/4" and 2 1/4" thick doors
- US-cylinder above handle
- Compatible with TEDEE smart locks

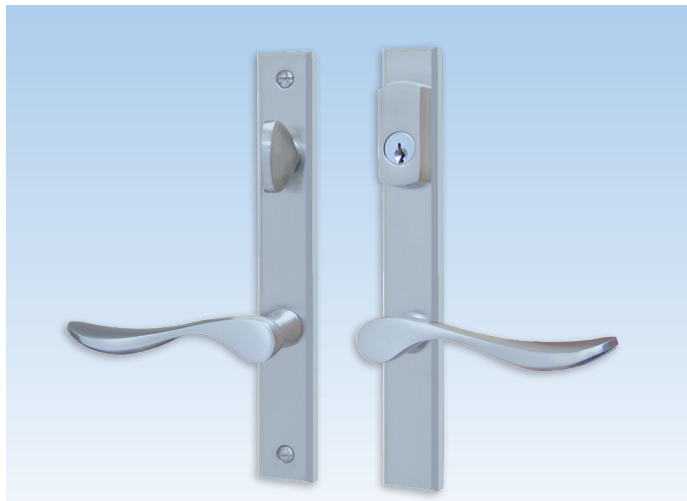

VENICE Zamac Trim Kits

| Description | PU | Part Number |
|--|----|---------------------|
| Handle sets for active doors with US-cylinder | 1 | K-U5692-Z1-0-* |
| Handle sets for semi-active doors | 1 | K-U5646-Z0-0-* |
| Handle sets for fixed doors | 1 | K-U5610-Z0-0-* |
| Handle sets for TEDEE Smart Lock | 1 | K-U5692-T1-0-* |
| * = Color | | PU = Packaging Unit |
| 01 = Satin Chrome, 5 = Dark Bronze PC, 6 = Black PC, 28 = Pewter | | |

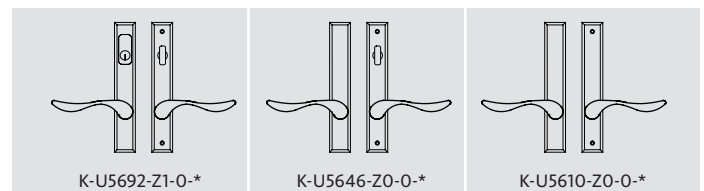
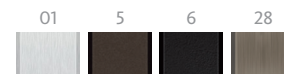

Additional information

- Unassembled zamac trim kits
- US-cylinder with standard 5 pins Schlage "C" keyway
- 90° locking with thumb-turn
- Self-centering 8mm spindle

- Stainless steel set screw on levers to secure spindle
- Patented handle clipping system
- Kit for 1 3/4" and 2 1/4" thick doors
- US-cylinder above handle
- Compatible with TEDEE smart locks



Additional information

- Unassembled solid brass trim kits
- US-cylinder with standard 5 pins Schlage "C" keyway
- 90° locking with thumb-turn
- Self-centering 8mm spindle



Additional information

- Unassembled zamac trim kits
- US-cylinder with standard 5 pins Schlage "C" keyway
- 90° locking with thumb-turn
- Self-centering 8mm spindle

CAPRI Solid Brass Trim Kits

| Description | PU | Part Number |
|--|----|---------------------|
| Handle sets for active doors with US-cylinder | 1 | K-U6292-01-0-* |
| Handle sets for semi-active doors | 1 | K-U6246-00-0-* |
| Handle sets for fixed doors | 1 | K-U6210-00-0-* |
| Handle sets for TEDEE Smart Lock | 1 | K-U6292-T1-0-* |
| * = Color | | PU = Packaging Unit |
| 01 = Satin Chrome, 03 = Polished Brass, 04 = Antique Brass, 05 = Oil Rubbed Bronze, 11 = Satin Nickel, 28 = Pewter | | |

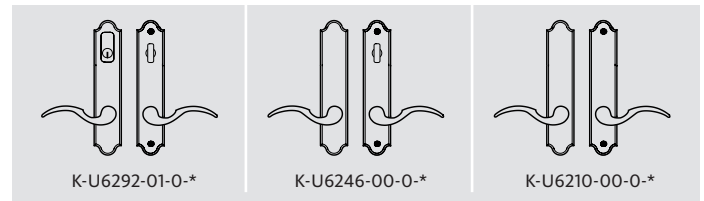
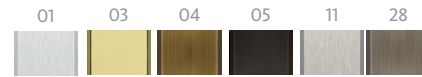

- Stainless steel set screw on levers to secure spindle
- Patented handle clipping system
- Kit for 1 3/4" and 2 1/4" thick doors
- US-cylinder above handle
- Compatible with TEDEE smart locks

CAPRI Zamac Trim Kits

| Description | PU | Part Number |
|---|----|---------------------|
| Handle sets for active doors with US-cylinder | 1 | K-U7292-Z1-0-* |
| Handle sets for semi-active doors | 1 | K-U7246-Z0-0-* |
| Handle sets for fixed doors | 1 | K-U7210-Z0-0-* |
| Handle sets for TEDEE Smart Lock | 1 | K-U7292-T1-0-* |
| * = Color | | PU = Packaging Unit |
| 5 = Dark Bronze PC, 6 = Black PC, | | |

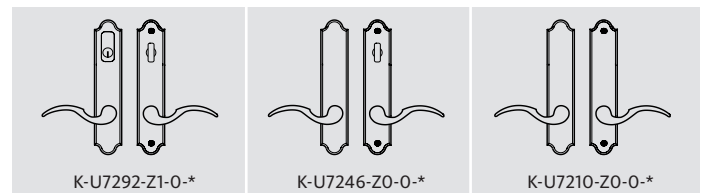
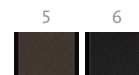

- Stainless steel set screw on levers to secure spindle
- Patented handle clipping system
- Kit for 1 3/4" and 2 1/4" thick doors
- US-cylinder above handle
- Compatible with TEDEE smart locks



Additional information

- Unassembled solid brass trim kits
- US-cylinder with standard 5 pins Schlage "C" keyway
- 90° locking with thumb-turn
- Self-centering 8mm spindle



Additional information

- Unassembled zamac trim kits
- US-cylinder with standard 5 pins Schlage "C" keyway
- 90° locking with thumb-turn
- Self-centering 8mm spindle

TORINO Solid Brass Trim Kits

| Description | PU | Part Number |
|--|----|---------------------|
| Handle sets for active doors with US-cylinder | 1 | K-U6492-01-0-* |
| Handle sets for semi-active doors | 1 | K-U6446-00-0-* |
| Handle sets for fixed doors | 1 | K-U6410-00-0-* |
| Handle sets for TEDEE Smart Lock | 1 | K-U6492-T1-0-* |
| * = Color | | PU = Packaging Unit |
| 01 = Satin Chrome, 03 = Polished Brass, 04 = Antique Brass, 05 = Oil Rubbed Bronze, 11 = Satin Nickel, 28 = Pewter | | |

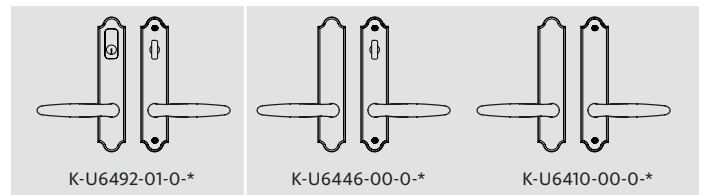
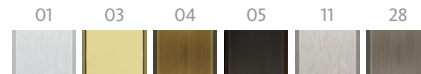

- Stainless steel set screw on levers to secure spindle
- Patented handle clipping system
- Kit for 1 3/4" and 2 1/4" thick doors
- US-cylinder above handle
- Compatible with TEDEE smart locks

TORINO Zamac Trim Kits

| Description | PU | Part Number |
|--|----|---------------------|
| Handle sets for active doors with US-cylinder | 1 | K-U7492-Z1-0-* |
| Handle sets for semi-active doors | 1 | K-U7446-Z0-0-* |
| Handle sets for fixed doors | 1 | K-U7410-Z0-0-* |
| Handle sets for TEDEE Smart Lock | 1 | K-U7492-T1-0-* |
| * = Color | | PU = Packaging Unit |
| 01 = Satin Chrome, 5 = Dark Bronze, 6 = Black, 28 = Pewter | | |

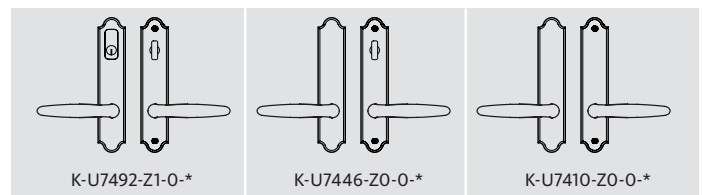
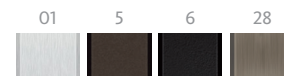

- Stainless steel set screw on levers to secure spindle
- Patented handle clipping system
- Kit for 1 3/4" and 2 1/4" thick doors
- US-cylinder above handle
- Compatible with TEDEE smart locks

VENICE Handle & 45mm Plate



Additional information

- Unassembled solid brass trim kits
- US-cylinder with standard 5 pins Schlage "C" keyway
- 90° locking with thumb-turn
- Self-centering 8mm spindle

VENICE Solid Brass Trim Kits

| Description | PU | Part Number |
|--|----|---------------------|
| Handle sets for active doors with US-cylinder | 1 | K-U6692-01-0-* |
| Handle sets for semi-active doors | 1 | K-U6646-00-0-* |
| Handle sets for fixed doors | 1 | K-U6610-00-0-* |
| Handle sets for TEDEE Smart lock | 1 | K-U6692-T1-0-* |
| * = Color | | PU = Packaging Unit |
| 01 = Satin Chrome, 03 = Polished Brass, 04 = Antique Brass, 05 = Oil Rubbed Bronze, 11 = Satin Nickel, 28 = Pewter | | |

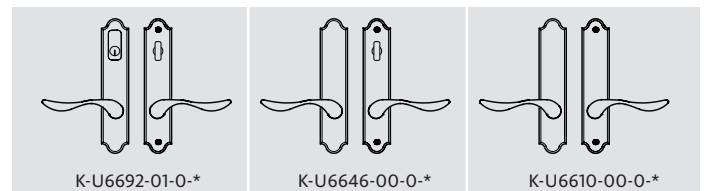
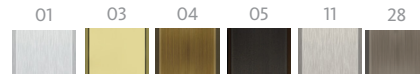

- Stainless steel set screw on levers to secure spindle
- Patented handle clipping system
- Kit for 1 3/4" and 2 1/4" thick doors
- US-cylinder above handle
- Compatible with TEDEE smart locks



Additional information

- Unassembled zamac trim kits
- US-cylinder with standard 5 pins Schlage "C" keyway
- 90° locking with thumb-turn
- Self-centering 8mm spindle

VENICE Zamac Trim Kits

| Description | PU | Part Number |
|--|----|---------------------|
| Handle sets for active doors with US-cylinder | 1 | K-U7692-Z1-0-* |
| Handle sets for semi-active doors | 1 | K-U7646-Z0-0-* |
| Handle sets for fixed doors | 1 | K-U7610-Z0-0-* |
| Handle sets for TEDEE Smart Lock | 1 | K-U7692-T1-0-* |
| * = Color | | PU = Packaging Unit |
| 01 = Satin Chrome, 5 = Dark Bronze PC, 6 = Black PC, 28 = Pewter | | |

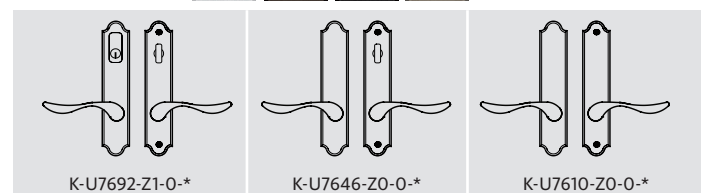
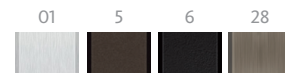

- Stainless steel set screw on levers to secure spindle
- Patented handle clipping system
- Kit for 1 3/4" and 2 1/4" thick doors
- US-cylinder above handle
- Compatible with TEDEE smart locks

ROMA Handle & 55mm Plates



Additional information

- Unassembled solid brass trim kits
- US-cylinder with standard 5 pins Schlage "C" keyway
- 90° locking with thumb-turn
- Self-centering 8mm spindle

ROMA Solid Brass Trim Kits

| Description | PU | Part Number |
|---|----|---------------------|
| Handle sets for active doors with US-cylinder | 1 | K-U4092-01-0-* |
| Handle sets for semi-active doors | 1 | K-U4046-00-0-* |
| Handle sets for fixed doors | 1 | K-U4010-00-0-* |
| Handle sets for TEDEE Smart Lock | 1 | K-U4092-T1-0-* |
| * = Color | | PU = Packaging Unit |

11 = Satin Nickel, 28 = Pewter

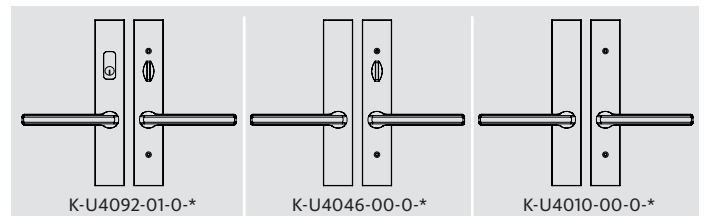
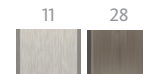

- Stainless steel set screw on levers to secure spindle
- Patented handle clipping system
- Kit for 1 3/4" and 2 1/4" thick doors
- US-cylinder above handle
- Compatible with TEDEE smart locks



Additional information

- Unassembled zamac trim kits
- US-cylinder with standard 5 pins Schlage "C" keyway
- 90° locking with thumb-turn
- Self-centering 8mm spindle

ROMA Zamac Trim Kits

| Description | PU | Part Number |
|---|----|---------------------|
| Handle sets for active doors with US-cylinder | 1 | K-U9092-Z1-0-* |
| Handle sets for semi-active doors | 1 | K-U9046-Z0-0-* |
| Handle sets for fixed doors | 1 | K-U9010-Z0-0-* |
| Handle sets for TEDEE smart lock | 1 | K-U9092-T1-0-* |
| * = Color | | PU = Packaging Unit |

5 = Dark Bronze, 6 = Black PC

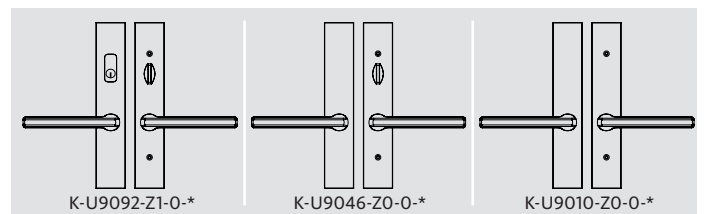
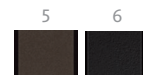

- Stainless steel set screw on levers to secure spindle
- Patented handle clipping system
- Kit for 1 3/4" and 2 1/4" thick doors
- US-cylinder above handle
- Compatible with TEDEE smart locks

BERLIN Handle & 65mm Plates



BERLIN Solid Brass Trim Kits

| Description | PU | Part Number |
|---|----|---------------------|
| Handle sets for active doors with US-cylinder | 1 | K-U2592-01-0-* |
| Handle sets for semi-active doors | 1 | K-U2546-00-0-* |
| Handle sets for fixed doors | 1 | K-U2510-00-0-* |
| Handle sets for TEDEE smart lock | 1 | K-U2592-T1-0-* |
| * = Color | | PU = Packaging Unit |

11 = Satin Nickel, 28 = Pewter

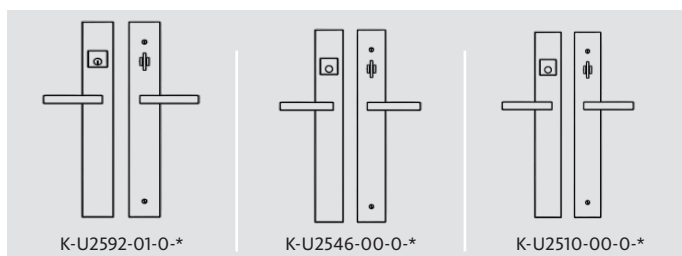
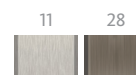

Additional information

- Unassembled Solid Brass trim kits
- US-cylinder with standard 5 pins Schlage "C" keyway
- New snapping mechanism for the 90° locking with thumb-turn
- Self-centering 8mm spindle
- Stainless steel set screw on levers to secure spindle
- Patented handle clipping system
- Kit for 1 3/4" and 2 1/4" thick doors
- US-cylinder above handle
- Compatible with TEDEE smart locks

- Active trim kits are converted to Semi-Active and Dummy using a pre-assembled cylinder plug and screw-in Dummy brackets (included in the kits)
- Minimum backset required: 50mm



Additional information

- Unassembled Zamac trim kits
- US-cylinder with standard 5 pins Schlage "C" keyway
- New snapping mechanism for the 90° locking with thumb-turn
- Self-centering 8mm spindle
- Stainless steel set screw on levers to secure spindle
- Patented handle clipping system
- Kit for 1 3/4" and 2 1/4" thick doors
- US-cylinder above handle
- Compatible with TEDEE smart locks

BERLIN Zamac Trim Kits

| Description | PU | Part Number |
|---|----|---------------------|
| Handle sets for active doors with US-cylinder | 1 | K-U8592-Z1-0-* |
| Handle sets for semi-active doors | 1 | K-U8546-Z0-0-* |
| Handle sets for fixed doors | 1 | K-U8510-Z0-0-* |
| Handle sets for TEDEE smart lock | 1 | K-U8592-T1-0-* |
| * = Color | | PU = Packaging Unit |
| 5 = Dark Bronze PC, 6 = Black PC | | |

5 6

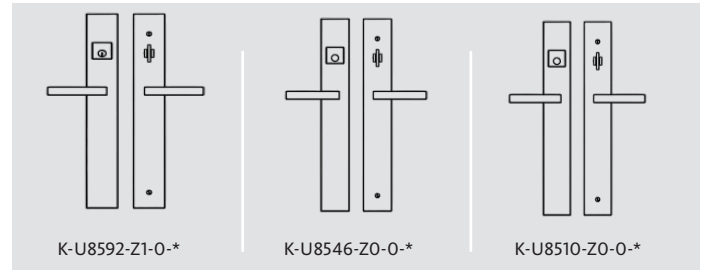
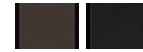

- Active trim kits are converted to Semi-Active and Dummy using a pre-assembled cylinder plug and screw-in Dummy brackets (included in the kits)
- Minimum backset required: 50mm

BELCANTO Handles & US Rosettes

for Door Lock



US rosettes

| Description | PU | Part Number |
|--|----|----------------|
| US lock kit for DB | 1 | K-C0370-00-0-* |
| US lock cyl. kit without knob for TEDEE Smart Lock | 1 | K-C0370-T1-0-* |

* = Color PU = Packaging Unit

8B = Stainless Steel, 6V = Matte Black



Additional information

- Made of stainless steel
- Fastening kit included for 1 3/4" and 2 1/4" doors
- Foam gasket
- Compatible with smart lock TEDEE Pro
- For doors thicker than 2 1/4" up to 2 3/4" use M5 x 80mm (not included) and 90mm cylinder (6-C0971-90-0-1)
- For doors thicker than 2 3/4" up to 3" use M5 x 90mm (not included) and 90mm cylinder (6-C0971-90-0-1)
- US lock cyl. kit for Smart Lock comes without knob and allen key



Belcanto Handle Set

| Description | PU | Part Number |
|-----------------------------------|----|----------------|
| Kit of inside and outside handles | 1 | K-C9071-00-0-* |

* = Color PU = Packaging Unit

8B = Stainless Steel, 6= Black , 6V = Matte Black

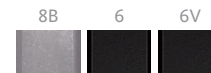

Additional information

- Handles and Rosettes made of stainless steel
- Fastening kit included for 1 3/4" and 2 1/4" doors
- Fixed lever spring loaded - can't be lifted
- 8mm square spindle x 110 mm included
- Concealed fixing screws
- Compatible with smart lock TEDEE Pro
- For doors 3" use screws (9-C0570-90-0-1) and 130mm spindle (9-U8100-30-0-8)

VENTO Handles

for Door Lock

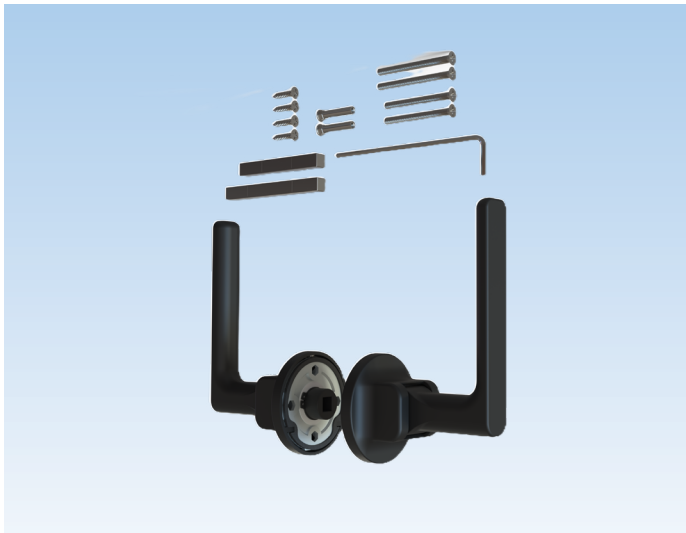
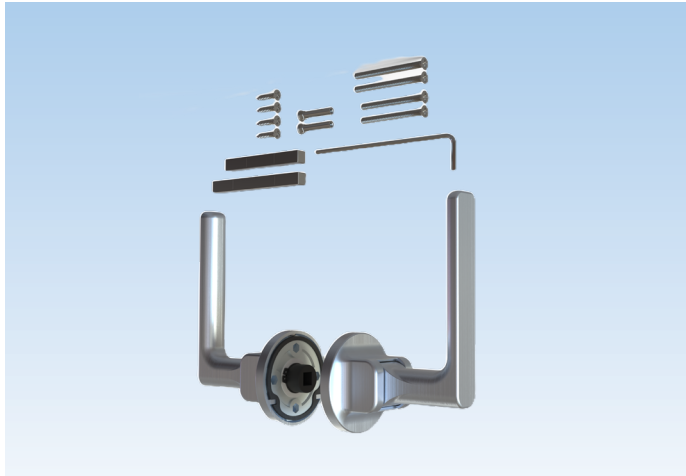

VENTO Handle Set

| Description | PU | Part Number |
|-----------------------------------|----|---------------------|
| Kit of inside and outside handles | 1 | K-C0360-00-0-* |
| * = Color | | PU = Packaging Unit |

8B = Stainless Steel, 6V = Matte Black



Additional information

- Handles and Rosettes made of stainless steel
- Foam gasket
- 8mm square spindle x 65 mm included (for 1 3/4" doors)
- 8mm square spindle x 78 mm included (for 2 1/4" doors)
- Concealed fixing screws
- Compatible with smart lock (TEDEE Pro)
- Should be ordered with K-C0370-00-0-* - US rosette for N-A configuration

Smart locks

for Door Lock

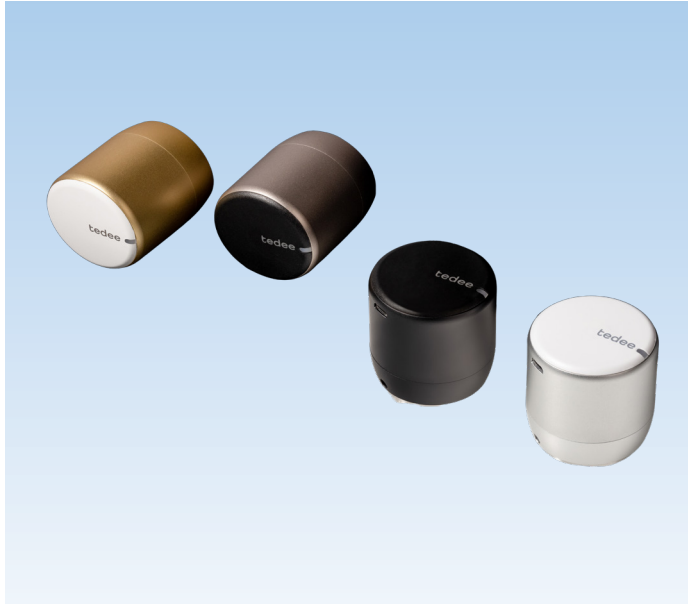

Smart lock

| Description | PU | Part Number |
|----------------------|----|---------------------|
| TEDEE PRO Smart Lock | 1 | 6-C9370-00-0-* |
| * = Color | | PU = Packaging Unit |

1 = Silver, 6 = Black , 73 = White Gold , 61 = Black Grey



Additional information

- Rechargeable 3000 mAh LiPo battery (included)
- Bluetooth BLE 5.0 2,4 GHz (TEDEE app) and Internet connection
- Security TLS 1.3
- Compatible with all Ferco handles (Lever & Gripset)



TEDEE Smart lock remote access (Wi-Fi)

| Description | PU | Part Number |
|--------------------|----|---------------------|
| TEDEE Smart Bridge | 1 | 6-C9382-00-0-7 |
| | | PU = Packaging Unit |

Additional information

- Dimensions 63.5 x 63.5 x 28 mm / Weight 51.6g
- Power connection socket plug (included) or micro-USB (cable not included)
- Wi-Fi 2.4 GHz and 5.0 GHz
- Bluetooth 5.0 2.4 GHz
- Security TLS 1.3
- Compatible with TEDEE smart lock 6-C9370-00-0-X and Bluetooth Keypad 6-C9387-00-0-6
- Works with smart home systems
- Up to 5 Smart Locks can be controlled (Bluetooth Range)



Bluetooth keypad 2.0

| Description | PU | Part Number |
|------------------|----|---------------------|
| TEDEE Keypad 2.0 | 1 | 6-C9387-01-0-* |
| * = Color | | PU = Packaging Unit |

6 = Black, 7 = White

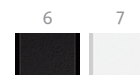

Additional information

- 3 X AAA batteries (included)
- Bluetooth 5.0 2,4 GHz
- Security TLS 1.3
- Up to 100 unique PINS
- Backlighted buttons, Sound signal, Bell button and more
- IP65 protection class
- Compatible with TEDEE smart lock 6-9370-00-0-X and bridge 6-C9382-00-0-7
- Finger print activated



TEDEE Door sensor

| Description | UE | Part Number |
|-------------------|----|---------------------|
| TEDEE Door Sensor | 1 | 6-C9390-00-0-* |
| * = Color | | PU = Packaging Unit |

6 = Black, 7 = White



Additional information

- Sensor Dimensions 30 × 64 × 14 mm
- Magnet Dimensions 17 × 64 × 7 mm
- Power Supply CR2032 battery
- 2.4 GHz to 2.483 GHz (Max output power: 8 dBm)
- 5°C to 50°C (indoor only)



Micro USB Cable

| Description | UE | Part Number |
|--------------------------------|----|----------------|
| Micro USB Cable for TEDEE Lock | 1 | 6-C9377-00-0-0 |
| PU = Packaging Unit | | |



Spare cap for TEDEE lock

| Description | PU | Part Number |
|--|----|---------------------|
| Blank front button cover for TEDEE PRO | 1 | 6-C9353-00-0-* |
| * = Color | | PU = Packaging Unit |

6V = Matte Black, 7 = White



Additional information

- Compatible with TEDEE PRO

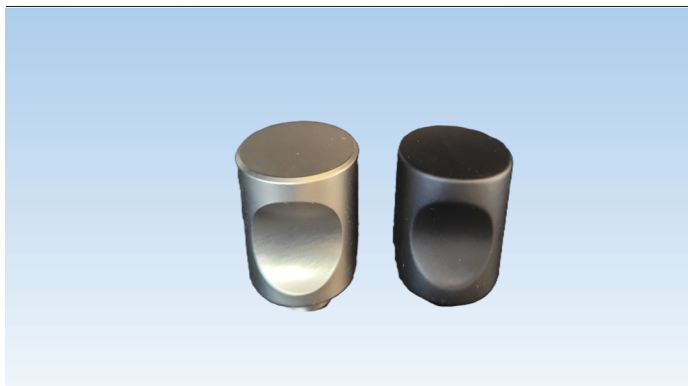

Knob for Profile cylinders for smart locks TEDEE

| Description | UE | Part Number |
|-------------------------|----|---------------------|
| Knob for TEDEE Cylinder | 1 | 6-U7359-00-0-* |
| | | PU = Packaging Unit |

11 = Satin Nickel, 6V = Matte Black



Additional information

- Used during door installation or servicing to prevent damage
- Replaces the TEDEE if necessary
- Compatible with TEDEE smart cylinders

Strike Plates

for Door Lock

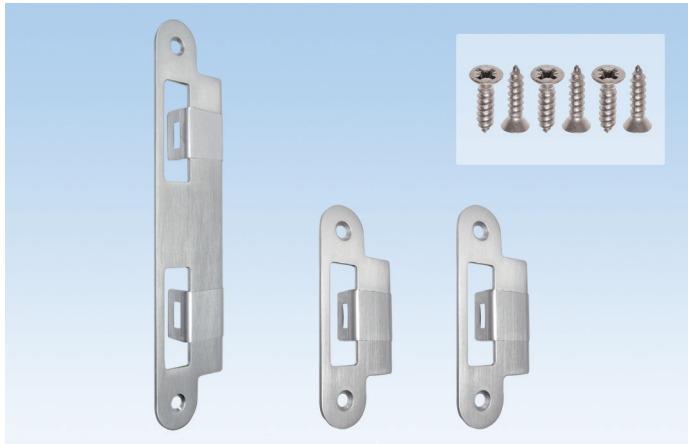

Bag of Strike Plates

| Description | PU | Part Number |
|---|----|---------------------|
| Bag of strike plates for 45mm (1 3/4") thick doors | 50 | K-C4774-45-0-* |
| Bag of strike plates for 57mm (2 1/4") thick doors | 50 | K-C4775-57-0-* |
| * = Color | | PU = Packaging Unit |
| 03 = Polished Brass, 04 = Antique Brass, 5 = Dark Bronze, 6 = Black, 11 = Satin Nickel, 28 = Pewter | | |

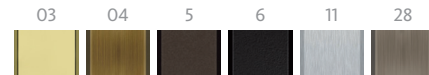

Additional information

- Solid brass (03, 04, 28) or stainless steel (5, 6, 11)
- Bag contains:
 - 1 middle striker with extended lip and clear protective film
 - 2 top and bottom strikers with extended lip and clear protective film
 - 6 screws
- Non-handed
- Available in handle matching finishes
- For use with GU-SECURY Automatic door locks

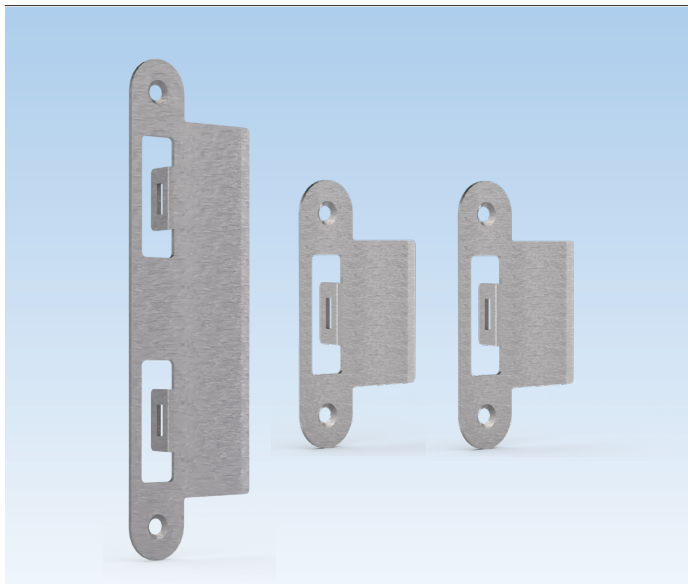

| Bag of Strike Plates | | |
|--|----|---------------------|
| Description | PU | Part Number |
| Bag of strike plates for 76mm (3") thick doors | 1 | K-C4777-59-0-* |
| * = Color | | PU = Packaging Unit |

8B = Stainless Steel, 6 = Black

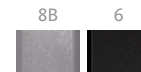

Additional information

- Made in stainless steel
- Bag contains:
 - 1 middle striker with extended lip
 - 2 top and bottom strikers with extended lip
- Non-handed
- For use with GU-SECURY Automatic door locks
- Six #8 x 5/8 FH/PH screws included

Strike Plates

for Door Lock

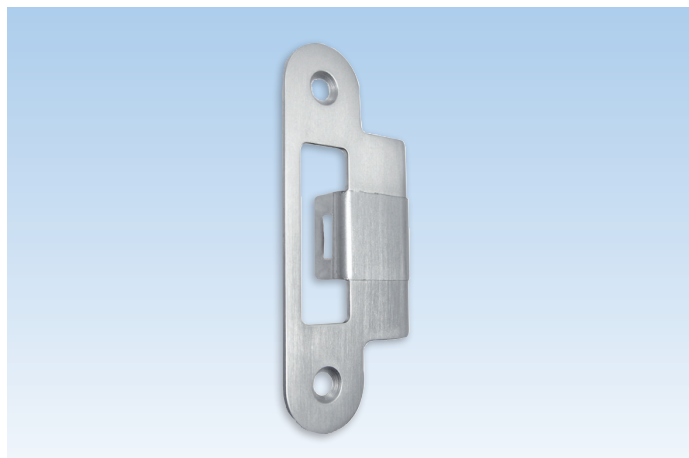

Top and Bottom Striker with Extended Lip

| Description | PU | Part Number |
|---|----|---------------------|
| Latchbolt strike plate for 45mm (1 3/4") thick doors | 10 | 9-C4776-45-0-* |
| Latchbolt strike plate for 57mm (2 1/4") thick doors | 10 | 9-C4776-57-0-* |
| * = Color | | PU = Packaging Unit |
| 03 = Polished Brass, 04 = Antique Brass, 5 = Dark Bronze, 6 = Black, 11 = Satin Nickel, 28 = Pewter | | |

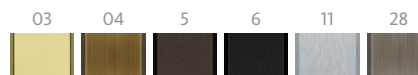

Additional information

- Solid brass (03, 04, 28) or stainless steel (5, 6, 11)
- Non-handed
- With clear protective film
- Available in handle matching finishes
- Two #8 x 5/8 FH/PH screws included
- For use with GU-SECURY Automatic door lock



| Description | PU | Part Number |
|---|----|---------------------|
| Latch and deadbolt strike plate for 45mm (1 3/4") thick doors | 10 | 9-C4777-45-0-* |
| Latch and deadbolt strike plate for 57mm (2 1/4") thick doors | 10 | 9-C4777-57-0-* |
| * = Color | | PU = Packaging Unit |
| 03 = Polished Brass, 04 = Antique Brass, 5 = Dark Bronze, 6 = Black, 11 = Satin Nickel, 28 = Pewter | | |

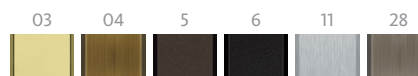

Additional information

- Solid brass (03, 04, 28) or stainless steel (5, 6, 11)
- Non-handed
- With clear protective film
- Available in handle matching finishes
- Two #8 x 5/8 FH/PH screws included
- For use with GU-SECURY SH2, S-Bolt, Automatic and mortise door locks

Strike Plates

for Door Lock

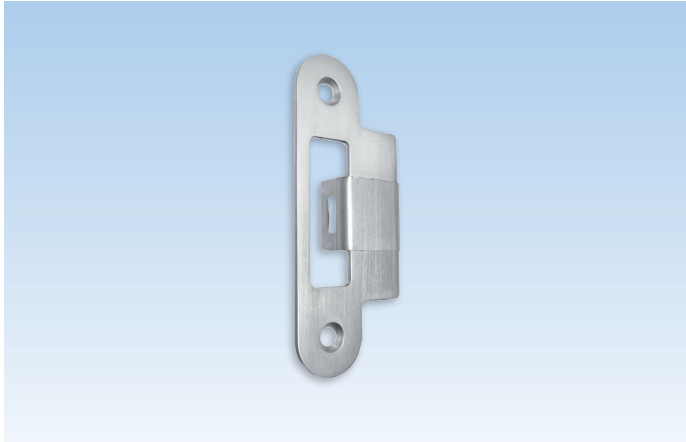

Top and Bottom Striker with Extended Lip

| Description | PU | Part Number |
|--|----|---------------------|
| Latchbolt strike plate for 76mm (3") thick doors | 10 | 9-C4716-59-0-* |
| * = Color | | PU = Packaging Unit |

8B = Stainless Steel, 6 = Black

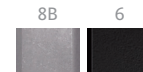

Additional information

- Made in stainless steel
- Non-handed
- Two #8 x 5/8 FH/PH screws not included
- For use with GU-SECURY Automatic door lock



Middle Striker with Extended Lip

| Description | PU | Part Number |
|---|----|---------------------|
| Latch and deadbolt strike plate for 76mm (3") thick doors | 10 | 9-C4717-59-0-* |
| * = Color | | PU = Packaging Unit |

8B = Stainless Steel, 6 = Black

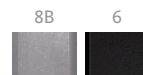

Additional information

- Made in stainless steel
- Non-handed
- Two #8 x 5/8 FH/PH screws not included
- For use with GU-SECURY Automatic door lock



Torx 15 T-Key

| Description | Color | PU | Part Number |
|---------------------|-------|----|----------------|
| Torx key | Steel | 1 | H-00346-15-0-0 |
| PU = Packaging Unit | | | |

Additional information

- Used for connecting SH2 and Automatic extensions



4mm Allen T-Key

| Description | Color | PU | Part Number |
|---------------------|-------|----|----------------|
| Allen key | Steel | 1 | H-00345-04-0-0 |
| PU = Packaging Unit | | | |

Additional information

- Used for reversing Automatic latchbolts on GU-SECURY Automatic lock and extension



Allen T-Key 2,5mm x 152mm

| Description | Color | PU | Part Number |
|-------------|-------|---------------------|----------------|
| Allen key | Steel | 1 | 6-C0560-20-0-0 |
| * = Color | | PU = Packaging Unit | |

Additional information

- Ideal for properly tightening the set screw of Ferco handle-set



PEEK Cream Cleaner

| Description | PU | Part Number |
|---------------------|----|-------------|
| 100mL tube | 1 | |
| PU = Packaging Unit | | |

Additional information

- Cleans, polishes and protects the surface
- Successfully used to clean SS surfaces on handles and pullbars
- Leaves behind a light and invisible protective coating
- Available at Amazon , Candian Tire or other hardware store



Handle Set Color Chips

| Description | PU | Part Number |
|---|----|---------------------|
| Color chips | 1 | K-C4780-00-0-0 |
| * = Color | | PU = Packaging Unit |
| 01 = Satin Chrome, 03 = Polished Brass, 04 = Antique Brass, 05 = Oil Rubbed Bronze, 5 = Dark Bronze, 6 = Black, 7 = White, 11 = Satin Nickel, 25 = Dark Bronze, 28 = Pewter | | |

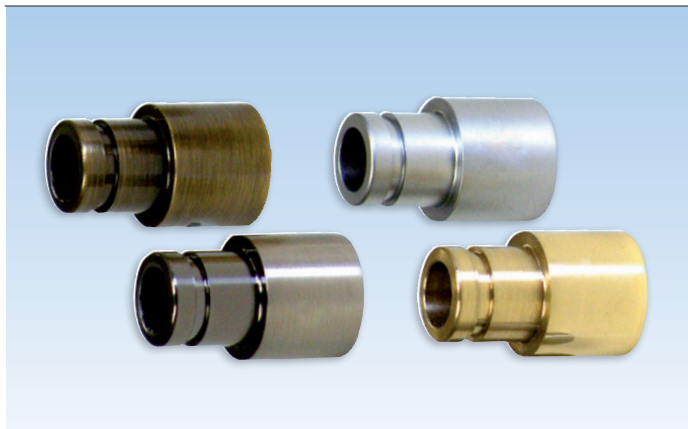

Handle Extenders

| Description | PU | Part Number |
|---|----|---------------------|
| Handle extenders | 1 | 9-C0695-00-0-* |
| * = Color | | PU = Packaging Unit |
| 01 = Satin Chrome, 03 = Polished Brass, 04 = Antique Brass, 05 = Oil Rubbed Bronze, 5 = Dark Bronze, 6 = Black, 25 = Dark Bronze, 28 = Pewter | | |

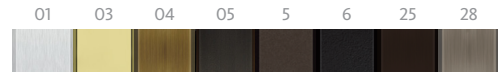

Additional information

- Made of solid brass
- Use with our solid brass handle sets
- Extends 18mm

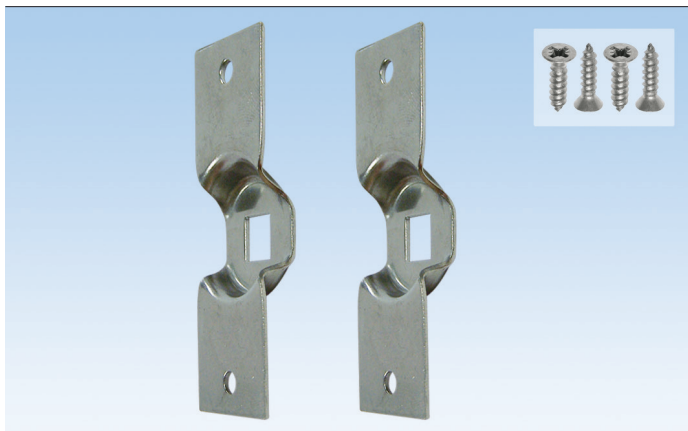

Fixing Plate for Dummy Trim Kits

| Description | PU | Part Number |
|---|----|----------------|
| Fixing plate used for fixed door handle | 50 | 9-U8210-00-0-3 |
| PU = Packaging Unit | | |

Additional information

- Made of zinc plated steel
- Bag of two dummy plates and four #6 x 5/8" FH/PH screws
- Included with Handle Dummy kits
- Part not required for Active & Semi-Active handles
- Fixing in the door



Fastening Screws

| Description | Color | PU | Part Number |
|---------------------|-----------------|------|----------------|
| D1 screws | Stainless Steel | 1000 | 9-C5362-32-0-8 |
| PU = Packaging Unit | | | |

Additional information

- Stainless steel lock fastening screws
- Type D1 with self-drilling spiral point and high duplex thread with "Quadrex" socket
- Sharp tip for quick drive

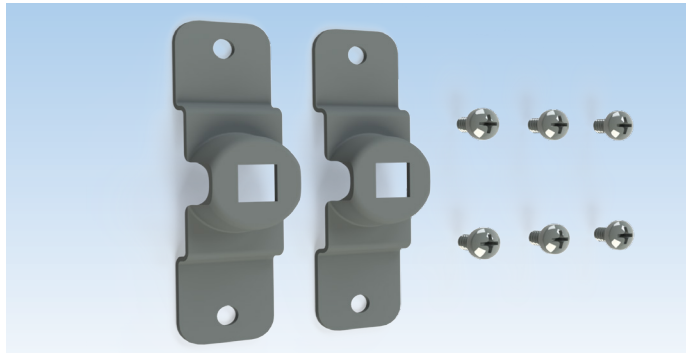

Fixing Plate for Dummy Trim Kits with 55 and 65mm plate

| Description | PU | Part Number |
|----------------------------------|----|----------------|
| Fixing Plate for Dummy trim kits | 1 | K-C0973-00-0-0 |
| PU = Packaging Unit | | |

Additional information

- Made of Zinc plated steel
- Bag of two dummy plates and six M4x5mm PH screws
- Included with 55 and 65mm plate Handle Dummy Kits
- Part not required for active and semi-active handles
- Fixing in the plate

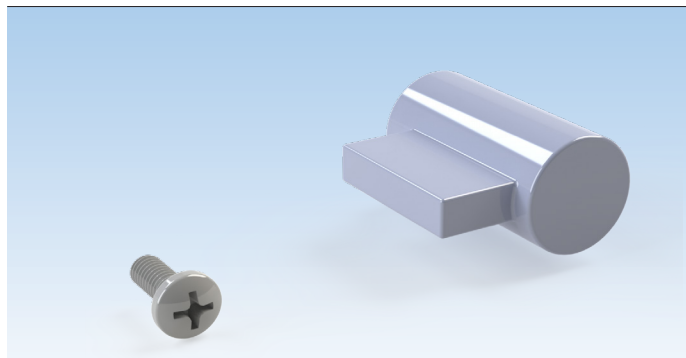

Dummy conversion kit

| Description | PU | Part Number |
|----------------------|----|---------------------|
| Dummy conversion kit | 1 | K-C0971-00-0-* |
| * = Color | | PU = Packaging Unit |

1 = Zinc, 25 = Dark Bronze

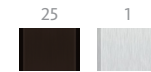

Additional information

- Made of Brass
- Bag of one dummy cylinder and one M4 x 10mm FH/PH screws
- Pre-installed with dummy & semi-active handles (65mm plate)
- Part not required for active handles

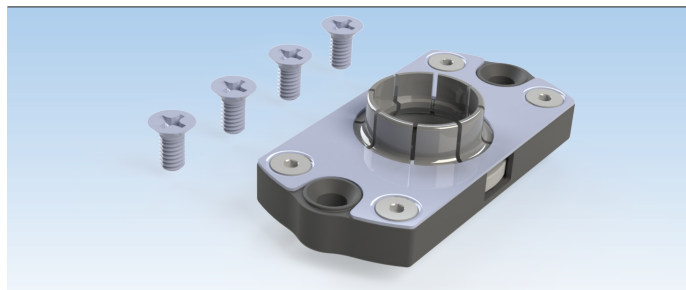

Replacement Snap & Turn box

| Description | PU | Part Number |
|---------------------|----|----------------|
| Snap & Turn Box | 1 | K-C2057-00-0-0 |
| PU = Packaging Unit | | |

Additional information

- Bag of one box and four M4 x 8mm FH/PH screws
- Included with handle sets with 65mm plate



Screws for Strike Plates

| Description | PU | Part Number |
|-------------------------|----|---------------------|
| #8 x 5/8" (16mm) screws | 10 | K-C4763-16-6-* |
| * = Color | | PU = Packaging Unit |

03 = Polished Brass, 04 = Antique Brass, 5 = Dark Bronze, 6 = Black, 11 = Satin Nickel, 28 = Pewter

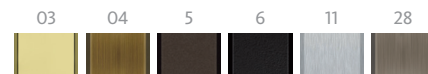

Additional information

- Bag of 6 screws for strike plates
- #8 x 5/8" FH/PH screws

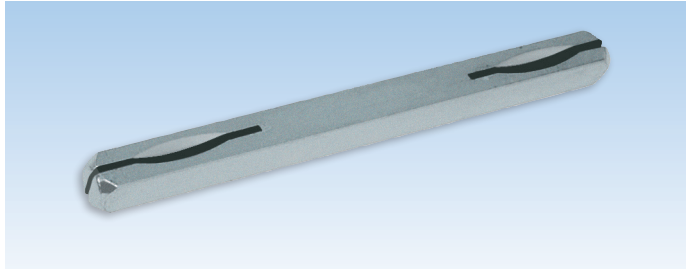

8mm Spindle

| Description | | PU | Part Number |
|--|------|----|----------------|
| 8 x 8 x 120mm spindle for 41-57mm thick doors <i>(1 spindle is supplied with door handle kit)</i> | Zinc | 10 | 9-U8100-20-0-8 |
| 8 x 8 x 130mm spindle for 57-76mm thick doors | Zinc | 10 | 9-U8100-30-0-8 |
| PU = Packaging Unit | | | |

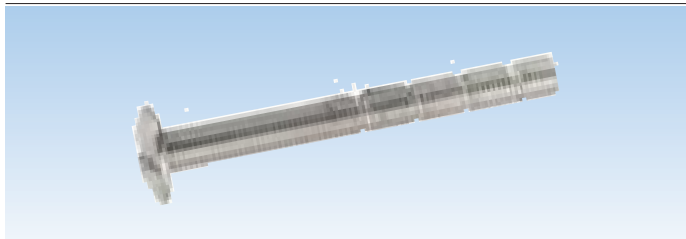

① For 41-76 mm thick doors

Re-cuttable M5 Screw

| Description | PU | Part Number |
|---|----|---------------------|
| ① M5 x 90mm screws <i>(2 screws are supplied with door handle kit)</i> | 1 | 9-U2510-90-R-* |
| M5 x 110mm screws | 1 | 9-U2510-10-R-* |
| * = Color | | PU = Packaging Unit |
| 01 = Satin Chrome, 03 = Polished Brass, 04 = Antique Brass, 05 = Oil Rubbed Bronze, 5 = Dark Bronze, 6 = Black, 7 = White, 11 = Satin Nickel, 25 = Dark Bronze, 28 = Pewter | | |

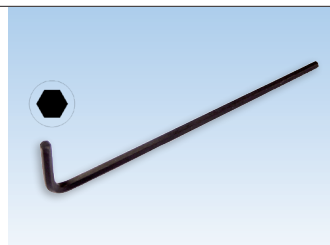

Set Screw & Allen Key

| Description | Color | PU | Part Number |
|---|-----------------|----|-----------------|
| M5 set screw <i>(2 screws are included with door handle kit)</i> | Stainless Steel | 1 | 9-U6008-05-0-1 |
| Allen key 2.5 x 20 x 100mm <i>(1 Allen key is supplied with door handle kit)</i> | Black | 1 | 9-U0003-00-0-00 |
| PU = Packaging Unit | | | |

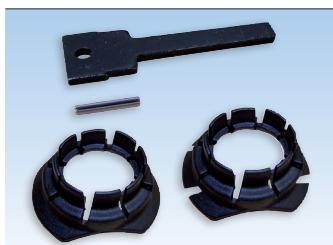

Knob Tail Replacement Kits

| Description | Color | PU | Part Number |
|--|-------|----|----------------|
| 48mm knob tail with snap rings | Black | 1 | K-C0600-48-0-0 |
| 72mm recutable knob tail with snap rings | Black | 1 | K-C0600-72-0-0 |
| PU = Packaging Unit | | | |

Additional information

- Knob tail made of tempered steel
- Used for semi-active handle trim kits
- 48 mm for doors from 1 3/4" to 2 3/4"
- 72mm recutable for doors from 2 3/4" to 3 5/8"



Snap Rings

| Description | Color | PU | Part Number |
|---|-------|----|-----------------|
| Snap ring (Handles purchased before 2021) | Black | 1 | 9-C0645-02-0-6A |
| Snap ring – low profile | Black | 1 | 9-C0645-03-0-6 |
| PU = Packaging Unit | | | |



Washers

| Description | Color | PU | Part Number |
|--|-------|----|----------------|
| Nylatron washer 0.25mm x 16mm (inner dia.) | Clear | 1 | 9-C0647-25-0-0 |
| Nylatron washer 0.5mm x 16mm (inner dia.) | Clear | 1 | 9-C0647-50-0-0 |
| Nylatron washer 1.0mm x 16mm (inner dia.) | Clear | 1 | 9-C0647-10-0-0 |
| PU = Packaging Unit | | | |



“O” Ring

| Description | Color | PU | Part Number |
|------------------------------------|-------|----|----------------|
| “O” ring 1.5mm x 16mm (inner dia.) | Black | 1 | 9-C0953-00-0-6 |
| PU = Packaging Unit | | | |



Cylinders Schlage “C” Keyway

| Description | Color | PU | Part Number |
|--|-------------|----|-----------------|
| ① Cylinder with 52mm tail and set of three keys | Zinc | 1 | 6-C0971-52-0-1 |
| | Brass | 1 | 6-C0971-52-0-3 |
| | Dark Bronze | 1 | 6-C0971-52-0-25 |
| ② Cylinder with 64mm tail and set of three keys | Zinc | 1 | 6-C0971-64-0-1 |
| | Dark Bronze | 1 | 6-C0971-64-0-25 |
| ③ Cylinder with 90 mm tail and set of three keys | Zinc | 1 | 6-C0971-90-0-1 |
| | Brass | 1 | 6-C0971-90-0-3 |
| | Dark Bronze | 1 | 6-C0971-90-0-25 |
| PU = Packaging Unit | | | |

Key Alike Cylinders Schlage “C” Keyway

| Description | Color | PU | Part Number |
|---|-------------|----|-----------------|
| ① Cylinder with 52mm tail and set of three keys | Zinc | 1 | 6-C0971-52-9-1 |
| | Brass | 1 | 6-C0971-52-9-3 |
| | Dark Bronze | 1 | 6-C0971-52-9-25 |
| ② Cylinder with 64mm tail and set of three keys | Zinc | 1 | 6-C0971-64-9-1 |
| | Dark Bronze | 1 | 6-C0971-64-9-25 |
| ③ Cylinder with 90mm tail and set of three keys | Zinc | 1 | 6-C0971-90-9-1 |
| | Brass | 1 | 6-C0971-90-9-3 |
| | Dark Bronze | 1 | 6-C0971-90-9-25 |
| PU = Packaging Unit | | | |

- ① For 41-57 mm thick doors with plate 30,45,55mm
- ② For 41-57 mm thick doors with plate 65mm
- ③ For 41-76 mm thick doors

Master Key : 9-C9990-CM-0-0
Key blank : 9-C0974-02-0-0

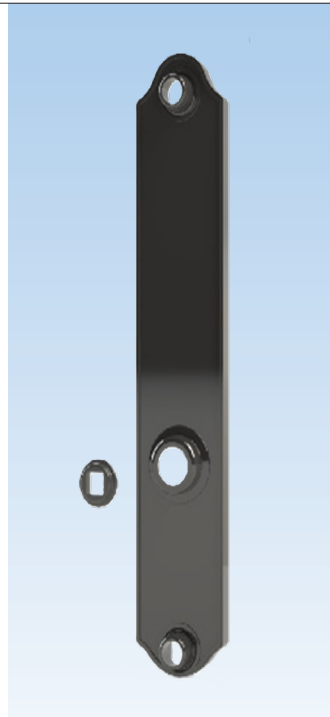
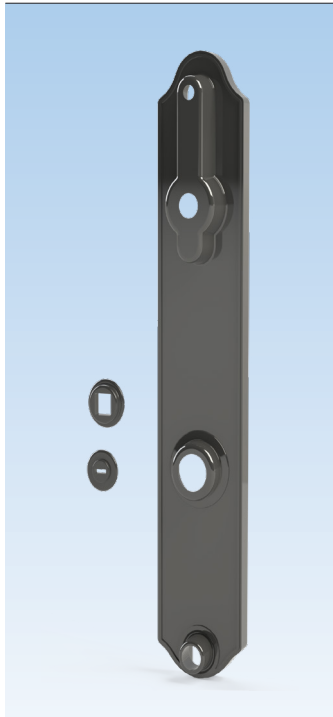
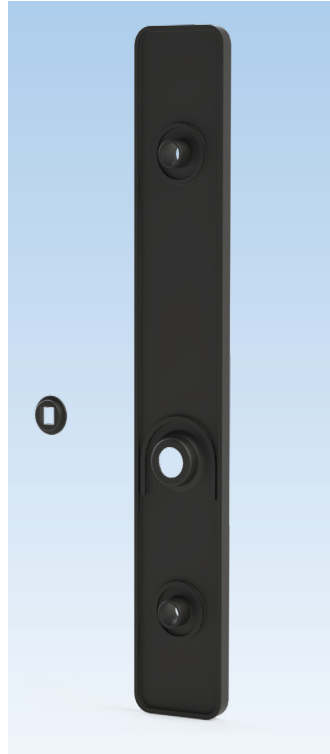

Gasket 55mm

| Description | Color | PU | Part Number |
|---------------------------|-------|----|----------------|
| Gasket for active plate | Black | 1 | 6-C0825-55-0-6 |
| Gasket for inactive plate | Black | 1 | 6-C0826-55-0-6 |
| PU = Packaging Unit | | | |

Additional information

- Not compatible with Dummy Handle fixing Plates K-C0973-00-0-0. To use this product in a dummy handle configuration, use fixing plates 6-C0800-03-0-0

Gasket 45mm

| Description | Color | PU | Part Number |
|---------------------------|-------|----|----------------|
| Gasket for active plate | Black | 1 | 6-C0825-00-0-6 |
| Gasket for inactive plate | Black | 1 | 6-C0826-00-0-6 |
| PU = Packaging Unit | | | |

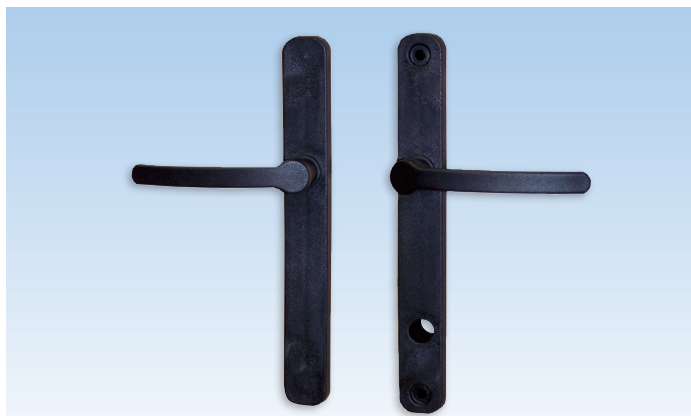

Construction Handle Set

| Description | Color | PU | Part Number |
|---------------------|-------|----|----------------|
| Construction handle | Black | 25 | K-C9250-25-0-6 |
| PU = Packaging Unit | | | |

Additional information

- Reinforced nylon temporary door trim sets
- 8 x 8 x 90mm square spindle included
- 4.2 x 50mm screws included
- For 1 3/4" thick doors
- Locking/Unlocking from inside only



Construction Key

| Description | Color | PU | Part Number |
|---------------------|-------|----|----------------|
| Construction key | Black | 10 | 9-U0001-01-0-0 |
| PU = Packaging Unit | | | |

Additional information

The construction key is available for those who prefer to install the decorative hardware trim and lever sets on doors after the construction has been completed. Installing the escutcheon plates and levers in the final stage of construction prevents the decorative trim from becoming scratched or damaged.

The construction key has been designed to accommodate multipoint door hardware (8mm square), tilt-turn hardware (7mm square) and lift-slide hardware (10mm square).



Dust Cup without Edge – 15mm

| Description | Color | PU | Part Number |
|---------------------|-------|-----|----------------|
| Plastic cup | Black | 10 | 9-C4765-0A-0-6 |
| | | 100 | 9-C4765-1C-A-6 |
| | | 500 | 9-C4765-5C-A-6 |
| PU = Packaging Unit | | | |

Additional information

- Dimensions:
- Length: 62mm , Width: 19.5mm, Depth: 16mm



Dust Cup Edge– 25mm

| Description | Color | PU | Part Number |
|---------------------|-------|-----|----------------|
| Plastic cup | Black | 10 | 9-C4765-00-0-6 |
| | | 100 | 9-C4765-1C-0-6 |
| | | 500 | 9-C4765-5C-0-6 |
| PU = Packaging Unit | | | |

Additional information

- Use for latch and 2 automatic latches (optional)
- Dimensions:
- Length: 62mm, Width: 19.5mm, Depth: 25.8mm

Handle Display

for Lever Handle



Handle Display with Lever Handles

| Description | PU | Part Number |
|--|----|---------------------|
| Handle display | 1 | 6-C9618-00-0-0 |
| * = Color | | PU = Packaging Unit |
| 01 = Satin Chrome, 03 = Polished Brass, 04 = Antique Brass, 05 = Oil Rubbed Bronze, 5 = Dark Bronze, 6 = Black, 11 = Satin Nickel, 28 = Pewter | | |

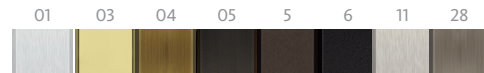

Additional information

- To be used with 30, 45 and 55mm escutcheons and Capri, Torino, Allegro, Venice or Roma handles
- When ordering, please pick handle, plate and finish
- 7" x 7" x 17" 1/4 (17.75 cm x 17.75 cm x 44 cm)



Handles Display with Lever Handles

| Description | PU | Part Number |
|---------------------|----|----------------|
| ROMA 55 | 1 | K-C9608-A0-0-7 |
| CAPRI | 1 | K-C9608-A2-0-7 |
| TORINO 30 | 1 | K-C9608-A4-0-7 |
| BERLIN 65 | 1 | K-C9608-A5-0-7 |
| VENISE 45 | 1 | K-C9608-A6-0-7 |
| ALLEGRO 30 | 1 | K-C9608-A8-0-7 |
| Display Base | 1 | 6-C9602-00-0-6 |
| PU = Packaging Unit | | |

* Models in this table are also available in French.

- Display delivered with wall mounted kit
- The display base is an option to place the unit on a desk, to be ordered separately
- 21" 1/2 x 32" x 12" (53.2 cm x 80.25 cm x 30.5 cm)

Handle Display

for Lever Handle and Door Lock



Handle Display with Door Lock and Handle

| Description | PU | Part Number |
|--------------------------------------|----|----------------|
| Handle display - 45mm (1 3/4") thick | 1 | K-C9615-00-0-9 |
| Handle display - Smart Lock TEDEE | 1 | K-C9619-SL-T-9 |
| PU = Packaging Unit | | |

Additional information

- Handle complete with lever handle and SECURY Automatic sample gear
- To be used with 30, 45 and 55mm escutcheons and Capri, Torino, Allegro, Venice or Roma handle
- Roma handle with TEDEE smart lock with K-C9619-SL-T-9
- When ordering, please add note for escutcheon, handle, and finish



Handle Display with US Rosette

| Description | PU | Part Number |
|--------------------------------------|----|----------------|
| Handle display - 45mm (1 3/4") thick | 1 | K-C9622-00-0-9 |
| Handle display - TEDEE Smart Lock | 1 | K-C9621-SL-T-9 |
| PU = Packaging Unit | | |

Additional information

- Handle complete with lever handle and SECURY Automatic sample gear
- To be used with US Rosette and Belcanto Handles
- US Rosette with TEDEE smart lock with K-C9621-SL-T-9
- When ordering, please add note for finish

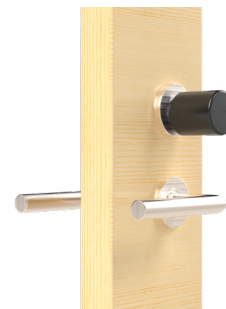

Handle Display

for Lever Handle and Door Lock



Handle Display with Door Lock and Handle

| Description | PU | Part Number |
|--|----|----------------|
| Handle display – 65mm Plate | 1 | K-C9642-00-0-9 |
| Handle display – 65 mm Plate with TEDEE Smart Lock | 1 | K-C9642-SL-T-9 |
| PU = Packaging Unit | | |

Additional information

- Handle complete with lever handle and SECURY Automatic sample gear
- 65 mm plate with TEDEE smart lock K-C9642-SL-T-9
- When ordering, please add note for finish



| VENTO Handle display US Pull bar 45 | | |
|---|----|----------------|
| Description | PU | Part Number |
| VENTO Handle display US Pull bar 45 | 1 | K-C9623-00-0-9 |
| VENTO Handle display US Pull bar 45-TEDEE | 1 | K-C9623-00-T-9 |
| PU = Packaging Unit | | |

Additional information

- 7" x 7" x 31" 3/4 (17.75 cm x 17.75 cm x 80.65 cm)
- When ordering, please provide the finish to all components (SS or Matte Black)



WINDOW TECHNOLOGY
DOOR TECHNOLOGY
AUTOMATIC ENTRANCE SYSTEMS
BUILDING MANAGEMENT SYSTEMS



QUÉBEC / MARITIMES

Ferco Ferrures de Bâtiment Inc.
2000, Rue Berlier
Laval, QC H7L 4S4
Canada

T 450 973-1437
1 800 355-8810
F 450 973-7661
ferco@ferco.ca

ONTARIO / WESTERN PROVINCES

Ferco Architectural Hardware Inc.
T 905 282-9588
1 800 668-5310
F 905 282-9915

UNITED STATES

Ferco Architectural Hardware Inc.
T 1 800 927-1097
F 1 888 454-0161

www.ferco.ca

