



WINDOW TECHNOLOGY  
DOOR TECHNOLOGY  
AUTOMATIC ENTRANCE SYSTEMS  
BUILDING MANAGEMENT SYSTEMS



DOOR TECHNOLOGY – ORDER CATALOG | SECTION 03.2



## SECURY Automatic Door Lock & Lever Handle



Securing technology for you





# 03.2

## SECURY Automatic Door Lock & Lever Handle

### GEARS

SECURY Automatic Door Lock .....	03.2.3
Automatic Extension .....	03.2.4
Filler Pieces .....	03.2.5
Mortise Door Lock .....	03.2.6

### HANDLES

Introduction .....	03.2.7
Finishes for handle set program .....	03.2.8

### **30mm Plate Series**

ALLEGRO Trim Kits .....	03.2.10
TORINO Trim Kits .....	03.2.11
VENICE Trim Kits.....	03.2.12

### **45mm Plate Series**

CAPRI Trim Kits .....	03.2.13
TORINO Trim Kits .....	03.2.14
VENICE Trim Kits.....	03.2.15

### **55mm Plate Series**

ROMA Trim Kits.....	03.2.16
---------------------	---------

### **65mm Plate Series & BELCANTO Handle**

BERLIN Trim Kits .....	03.2.17
BERLIN Trim Kits .....	03.2.18
BELCANTO & VENTO Handle & US Rosette .....	03.2.19

### ACCESSORIES

Smart locks.....	03.2.21
Strike Plates .....	03.2.24
Accessories .....	03.2.25
Handle Displays.....	03.2.34

# SECURY Automatic Door Lock

for lever handle with North American Cylinder



Unlocked



Locked

**USE WITH LEVER HANDLES ONLY**

## SECURY Automatic Door Lock for Lever Handle

Description	Backset	Color	PU	Part Number
Door lock for 6' 8" doors	45mm	SS	5	6-35856-01-R-8B
Door lock for 8' doors	45mm	SS	5	6-35856-02-R-8B
Door lock for 6' 8" doors	50mm	SS	5	6-36033-01-R-8B
Door lock for 8' doors	50mm	SS	5	6-36033-02-R-8B
Door lock for 6' 8" doors	60mm	SS	5	6-35565-01-R-8B
Door lock for 8' doors	60mm	SS	5	6-35565-02-R-8B
Door lock for 6' 8" doors	70mm	SS	5	6-35565-05-R-8B
Door lock for 8' doors	70mm	SS	5	6-35565-06-R-8B

PU = Packaging Unit

### Simply Close the Door!

As soon as the door pulled shut, the Automatic latchbolts instantly throw 20mm and are secured to prevent them being forced back. By turning the key or the knob, the center deadbolt will engage and lock the top and bottom latchbolts to become a **3-deadbolt locking system**.

### Additional information

- 3-point, one piece locking system for 6' 8" and 8' doors
- Heavy duty mortise construction with reinforced lever return spring system
- Locking by US-cylinder with 90° turn of key or thumb-turn
- No lifting of handle to engage locking points
- Top and bottom Automatic latchbolt projection from 10 to 20mm:
  - Provides security
  - Protects the door
- 1" (25mm) throw on deadbolt with baby sitting function
- Non handed, latch easily reversible
- 8mm square spindle
- 92mm centres (spindle to cylinder)
- Handle height variable (36" recommended)
- 16mm stainless steel faceplate with radius ends for easy installation and cleaner look
- Same hardware groove detail throughout our entire door lock program (jig, router base and bits available)
- Various extension with additional lock point is available for doors taller than 8'
- To be used with lever handle set (US-cylinder above handle)

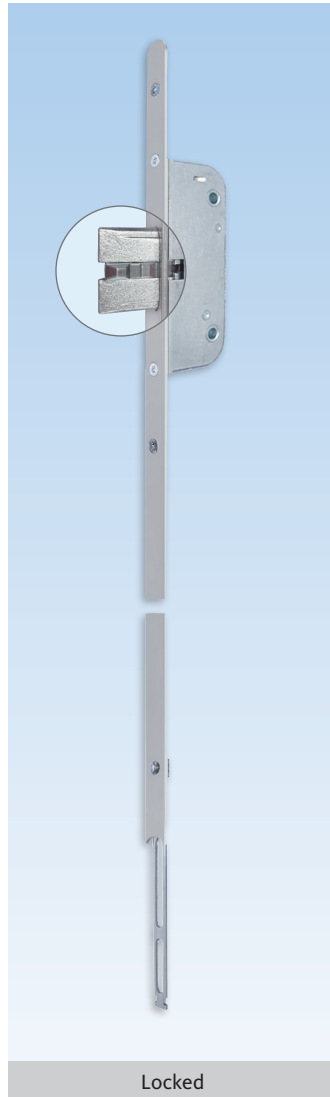
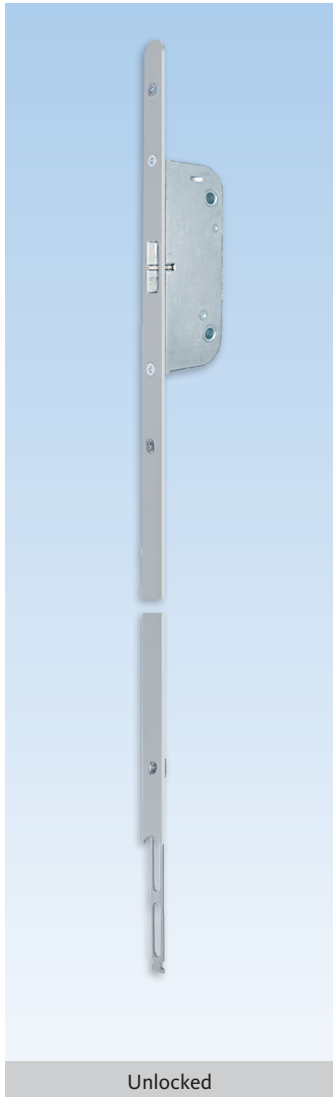

### Extension with Additional Latchbolt

Description	Color	PU	Part Number
525mm extension with rounded end	Stainless Steel	5	6-33479-04-0-8B
800mm extension with rounded end	Stainless Steel	1	6-C5078-00-0-8B
1050mm extension with rounded end	Stainless Steel	1	6-C5062-10-0-8B
1325mm extension with rounded end	Stainless Steel	1	6-C5062-13-0-8B
* = Color		PU = Packaging Unit	

### Additional information

- Tapered latch always engaging in strike plate
- 16mm stainless steel faceplate with radius end for easy installation and cleaner look
- Additional locking point for doors taller than 8'
- To be used with GU-SECURY Automatic door Locks

# Filler pieces

Round to square

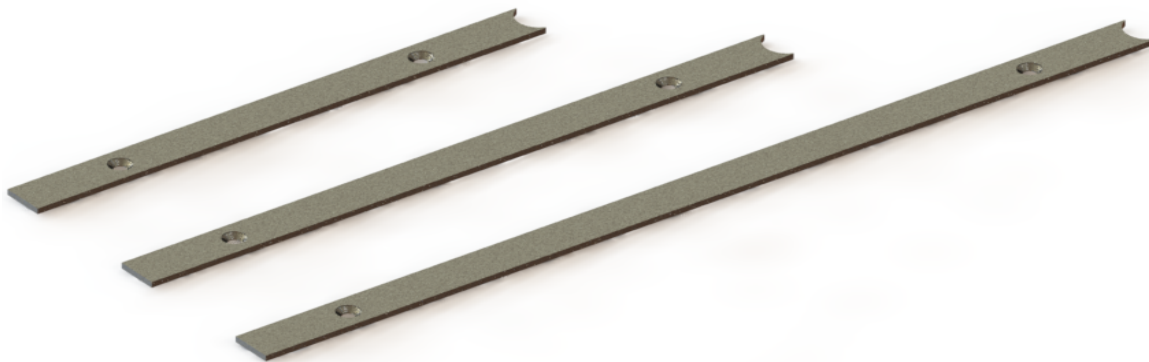

## Filler Pieces

Description	PU	Part Number
Filler piece 193,7mm	1	9-C4340-19-0-8B
Filler piece 245,9mm	1	9-C4342-24-0-8B
Filler piece 342,3mm	1	9-C4342-34-0-8B

## Additional information

- Made of stainless steel
- To be used with radius end locks and extensions

## Formulas to select filler length:

- Bottom:  
L = Handle height - 671,7mm
- Top 1590mm lock:  
L = Door height - handle height - extension(s) length - 920,7mm
- Top 1900mm lock:  
L = Door height - handle height - extension(s) length - 1230,7mm

# Mortise Door Lock

with Latch and Deadbolt



### Mortise Door Lock for Lever Handle

Description	Color	PU	Part Number
Door lock with 45mm backset	Stainless Steel	10	6-C4893-45-0-8B
Door lock with 50mm backset	Stainless Steel	10	6-C4893-50-0-8B
Door lock with 60mm backset	Stainless Steel	10	6-C4893-60-0-8B
Door lock with 70mm backset	Stainless Steel	10	6-C4893-70-0-8B
* = Color		PU = Packaging Unit	

### Additional information

- Heavy duty mortise construction with reinforced lever return spring system
- Locking by US-cylinder with 90° turn of key or thumb-turn to engage the 1" (25mm) deadbolt
- Non-handed, latch easily reversible
- 8mm square spindle
- 92mm centres (spindle to cylinder)
- 16mm stainless steel faceplate with radius ends for easy installation and cleaner look
- Same hardware groove detail throughout our entire door lock program (jig, router base and bits available)
- Ideal for exterior and interior door applications
- To be used with lever handle set (US-cylinder above handle)



**Ferco lever handle sets** are uniquely designed to operate on multipoint door locks. Our handle sets withstand the rigorous everyday operational wear & tear of engaging or disengaging multiple lock points. **Our handle sets are designed for long term use!**

- **Patented handle snap-rings** allow for handles to be shipped non-handed. The manufacturer no longer has to worry about ordering left or right, and will save on inventory.
- **Handle setscrews to fasten spindles** combined with the snap-ring will ensure the handle will stay tight on the door for a long time.
- **Self centering 8mm split Spindle** to make sure it is always centered into the door.
- **Longer Screw ports on escutcheons:** Ferco has added an interior sleeve port that will guide the M5 mm screw straight to the opposing exterior screw port.
- **Exterior O-ring on handle shaft** to prevent water from entering around the exterior handle.
- **Washers between handle and escutcheon** making sure the handle operation is and remains smooth.
- **Escutcheon Foam gasket** to prevent air and cold.
- **Rubber gasket** (Order separately) to prevent air and water leakage around the exterior escutcheon.
- **Schlage Cylinder with one tail for both 1 3/4" and 2 1/4" thick doors**
- **M5 handle set screws to fasten the escutcheons** included in every handle set kit.
- **Handle above cylinder or handle below cylinder option**
- **FERCO handle sets available** in Solid Brass or economical zinc die-cast material with selections in many plate designs, lever styles and finishes.

# Finishes For Handle Set Program

- US-Cylinder Above Handle









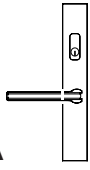
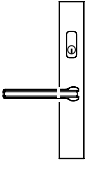
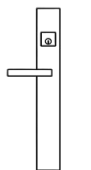
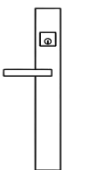
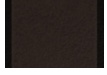

	SOLID BRASS						ZAMAC					
	45mm PLATE			30mm PLATE			45mm PLATE			30mm PLATE		
	<b>CAPRI</b> K-U6292-01 K-U6246-00 K-U6210-00	<b>TORINO</b> K-U6492-01 K-U6446-00 K-U6410-00	<b>VENICE</b> K-U6692-01 K-U6646-00 K-U6610-00	<b>ALLEGRO</b> K-U3192-01 K-U3146-00 K-U3110-00	<b>TORINO</b> K-U3492-01 K-U3446-00 K-U3410-00	<b>VENICE</b> K-U3692-01 K-U3646-00 K-U3610-00	<b>CAPRI</b> K-U7292-Z1 K-U7246-Z0 K-U7210-Z0	<b>TORINO</b> K-U7492-Z1 K-U7446-Z0 K-U7410-Z0	<b>VENICE</b> K-U7692-Z1 K-U7646-Z0 K-U7610-Z0	<b>ALLEGRO</b> K-U5192-Z1 K-U5146-Z0 K-U5110-Z0	<b>TORINO</b> K-U5492-Z1 K-U5446-Z0 K-U5410-Z0	<b>VENICE</b> K-U5692-Z1 K-U5646-Z0 K-U5610-Z0
Satin Chrome	01	01	01	01	01	01				01	01	01
Polished Brass	03	03	03	03	03	03						
Antique Brass	04	04	04	04	04	04						
Oil Rubbed Bronze	05	05	05	05	05	05						
Dark Bronze PC							5	5	5	5	5	5
Black PC							6	6	6	6	6	6
White PC												
Satin Nickel	11	11	11	11	11	11						
Dark Bronze												
Pewter	28	28	28	28	28	28		28	28	28	28	28

Colors on this document are graphic representation and may not be an exact match for the actual painted/plated hardware.  
For color selection, material samples are available on request.

# Finishes For Handle Set Program

- US-Cylinder Above Handle



	SOLID BRASS 55mm PLATE	ZAMAC 55mm PLATE	SOLID BRASS 65mm PLATE	ZAMAC 65mm PLATE
	 <p><b>ROMA</b> K-U4092-01 K-U4046-00 K-U4010-00</p>	 <p><b>ROMA</b> K-U9092-Z1 K-U9046-Z0 K-U9010-Z0</p>	 <p><b>BERLIN</b> K-U2592-Z1 K-U2546-Z0 K-U2510-Z0</p>	 <p><b>BERLIN</b> K-U8592-Z1 K-U8546-Z0 K-U8510-Z0</p>
Satin Chrome				
Polished Brass				
Antique Brass				
Oil Rubbed Bronze				
Dark Bronze PC		5 		5 
Black PC		6 		6 
White PC				
Satin Nickel	11 		11 	
Dark Bronze				
Pewter	28 		28 	

03  
2

Colors on this document are graphic representation and may not be an exact match for the actual painted/plated hardware.  
For color selection, material samples are available on request.



### ALLEGRO Solid brass Trim Kits

Description	PU	Part Number
Handle sets for active doors with US-cylinder	1	K-U3192-01-0-*
Handle sets for semi-active doors	1	K-U3146-00-0-*
Handle sets for fixed doors	1	K-U3110-00-0-*
Handle sets for TEDEE Smart Lock	1	K-U3192-T1-0-*
* = Color		PU = Packaging Unit
01 = Satin Chrome, 03 = Polished Brass, 04 = Antique Brass, 05 = Oil Rubbed Bronze, 11 = Satin Nickel, 28 = Pewter		

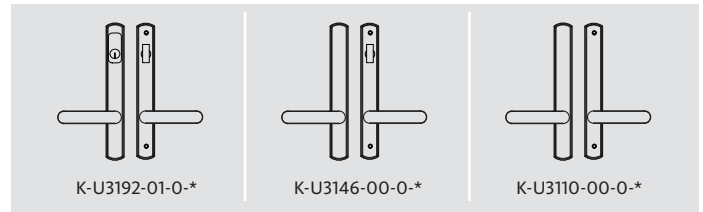
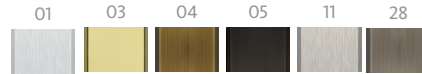

#### Additional information

- Unassembled solid brass trim kits
- US-cylinder with standard 5 pins Schlage "C" keyway
- 90° locking with thumb-turn
- Self-centering 8mm spindle

- Stainless steel set screw on levers to secure spindle
- Patented handle clipping system
- Kit for 1 3/4" and 2 1/4" thick doors
- US-cylinder above handle
- Compatible with TEDEE smart locks



### ALLEGRO Zamac Trim Kits

Description	PU	Part Number
Handle sets for active doors with US-cylinder	1	K-U5192-Z1-0-*
Handle sets for semi-active doors	1	K-U5146-Z0-0-*
Handle sets for fixed doors	1	K-U5110-Z0-0-*
Handle sets for TEDEE Smart Lock	1	K-U5192-T1-0-*
* = Color		PU = Packaging Unit
01 = Satin Chrome, 5 = Dark Bronze PC, 6 = Black PC, 28 = Pewter		

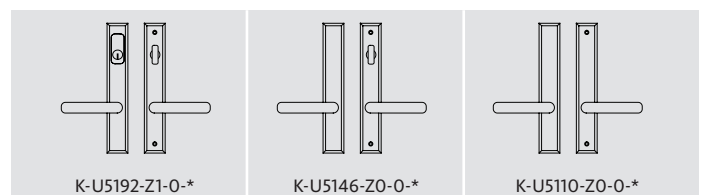
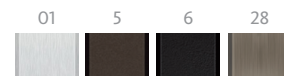

#### Additional information

- Unassembled zamac trim kits
- US-cylinder with standard 5 pins Schlage "C" keyway
- 90° locking with thumb-turn
- Self-centering 8mm spindle

- Stainless steel set screw on levers to secure spindle
- Patented handle clipping system
- Kit for 1 3/4" and 2 1/4" thick doors
- US-cylinder above handle
- Compatible with TEDEE smart locks

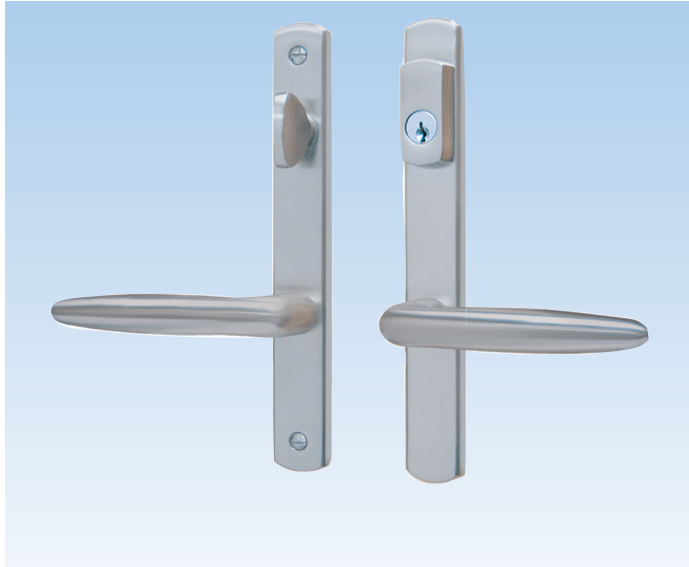

### Additional information

- Unassembled solid brass trim kits
- US-cylinder with standard 5 pins Schlage "C" keyway
- 90° locking with thumb-turn
- Self-centering 8mm spindle



### Additional information

- Unassembled zamac trim kits
- US-cylinder with standard 5 pins Schlage "C" keyway
- 90° locking with thumb-turn
- Self-centering 8mm spindle

### TORINO Solid brass Trim Kits

Description	PU	Part Number
Handle sets for active doors with US-cylinder	1	K-U3492-01-0-*
Handle sets for semi-active doors	1	K-U3446-00-0-*
Handle sets for fixed doors	1	K-U3410-00-0-*
Handle sets for TEDEE Smart Lock	1	K-U3492-T1-0-*

\* = Color      PU = Packaging Unit

01 = Satin Chrome, 03 = Polished Brass, 04 = Antique Brass,  
05 = Oil Rubbed Bronze, 11 = Satin Nickel, 28 = Pewter

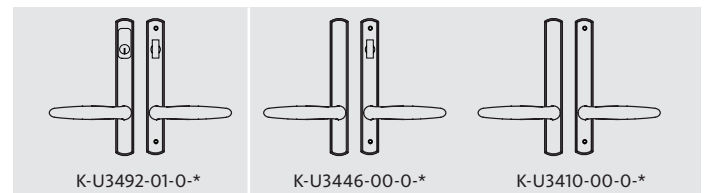
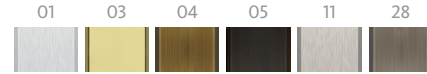

- Stainless steel set screw on levers to secure spindle
- Patented handle clipping system
- Kit for 1 3/4" and 2 1/4" thick doors
- US-cylinder above handle
- Compatible with TEDEE smart locks

### TORINO Zamac Trim Kits

Description	PU	Part Number
Handle sets for active doors with US-cylinder	1	K-U5492-Z1-0-*
Handle sets for semi-active doors	1	K-U5446-Z0-0-*
Handle sets for fixed doors	1	K-U5410-Z0-0-*
Handle sets for TEDEE Smart Lock	1	K-U5492-T1-0-*

\* = Color      PU = Packaging Unit

01 = Satin Chrome, 5 = Dark Bronze PC, 6 = Black PC, 28 = Pewter

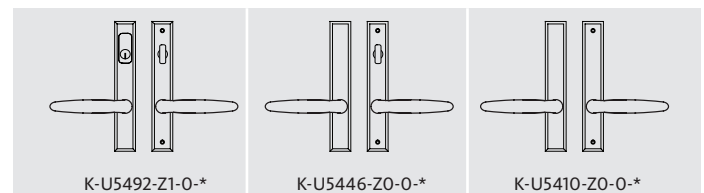
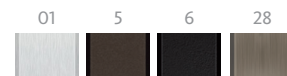

- Stainless steel set screw on levers to secure spindle
- Patented handle clipping system
- Kit for 1 3/4" and 2 1/4" thick doors
- US-cylinder above handle
- Compatible with TEDEE smart locks

# VENICE Handle & 30mm Plate



## VENICE Solid Brass Trim Kits

Description	PU	Part Number
Handle sets for active doors with US-cylinder	1	K-U3692-01-0-*
Handle sets for semi-active doors	1	K-U3646-00-0-*
Handle sets for fixed doors	1	K-U3610-00-0-*
Handle sets for TEDEE Smart Lock	1	K-U3692-T1-0-*
* = Color		PU = Packaging Unit
01 = Satin Chrome, 03 = Polished Brass, 04 = Antique Brass, 05 = Oil Rubbed Bronze, 11 = Satin Nickel, 28 = Pewter		

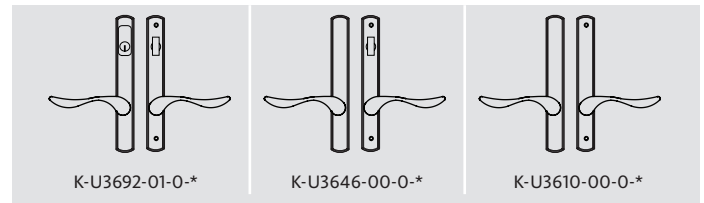
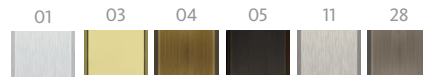

### Additional information

- Unassembled solid brass trim kits
- US-cylinder with standard 5 pins Schlage "C" keyway
- 90° locking with thumb-turn
- Self-centering 8mm spindle

- Stainless steel set screw on levers to secure spindle
- Patented handle clipping system
- Kit for 1 3/4" and 2 1/4" thick doors
- US-cylinder above handle
- Compatible with TEDEE smart locks

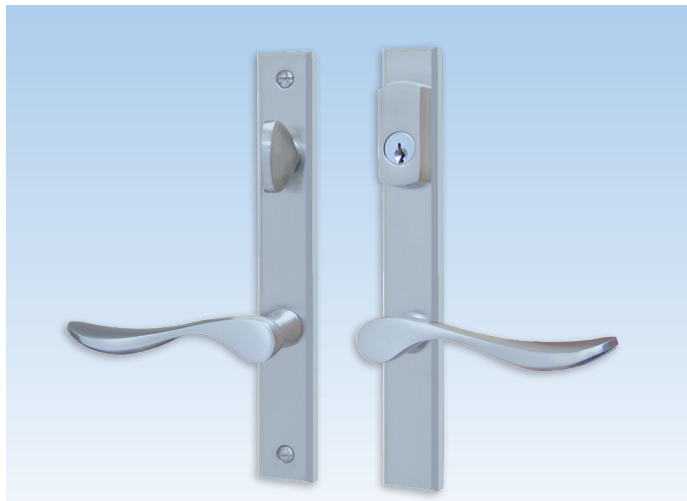

## VENICE Zamac Trim Kits

Description	PU	Part Number
Handle sets for active doors with US-cylinder	1	K-U5692-Z1-0-*
Handle sets for semi-active doors	1	K-U5646-Z0-0-*
Handle sets for fixed doors	1	K-U5610-Z0-0-*
Handle sets for TEDEE Smart Lock	1	K-U5692-T1-0-*
* = Color		PU = Packaging Unit
01 = Satin Chrome, 5 = Dark Bronze PC, 6 = Black PC, 28 = Pewter		

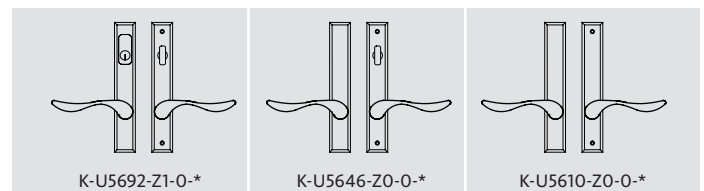
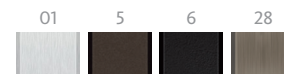

### Additional information

- Unassembled zamac trim kits
- US-cylinder with standard 5 pins Schlage "C" keyway
- 90° locking with thumb-turn
- Self-centering 8mm spindle

- Stainless steel set screw on levers to secure spindle
- Patented handle clipping system
- Kit for 1 3/4" and 2 1/4" thick doors
- US-cylinder above handle
- Compatible with TEDEE smart locks



### Additional information

- Unassembled solid brass trim kits
- US-cylinder with standard 5 pins Schlage "C" keyway
- 90° locking with thumb-turn
- Self-centering 8mm spindle



### Additional information

- Unassembled zamac trim kits
- US-cylinder with standard 5 pins Schlage "C" keyway
- 90° locking with thumb-turn
- Self-centering 8mm spindle

### CAPRI Solid Brass Trim Kits

Description	PU	Part Number
Handle sets for active doors with US-cylinder	1	K-U6292-01-0-*
Handle sets for semi-active doors	1	K-U6246-00-0-*
Handle sets for fixed doors	1	K-U6210-00-0-*
Handle sets for TEDEE Smart Lock	1	K-U6292-T1-0-*
* = Color		PU = Packaging Unit
01 = Satin Chrome, 03 = Polished Brass, 04 = Antique Brass, 05 = Oil Rubbed Bronze, 11 = Satin Nickel, 28 = Pewter		

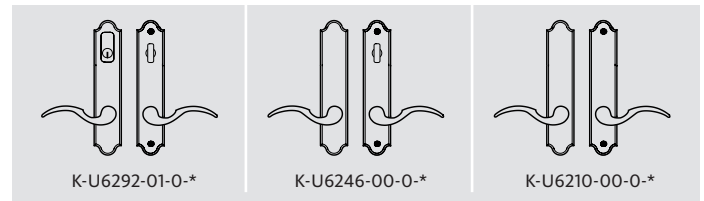
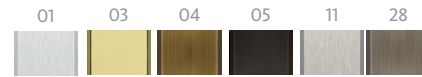

- Stainless steel set screw on levers to secure spindle
- Patented handle clipping system
- Kit for 1 3/4" and 2 1/4" thick doors
- US-cylinder above handle
- Compatible with TEDEE smart locks

### CAPRI Zamac Trim Kits

Description	PU	Part Number
Handle sets for active doors with US-cylinder	1	K-U7292-Z1-0-*
Handle sets for semi-active doors	1	K-U7246-Z0-0-*
Handle sets for fixed doors	1	K-U7210-Z0-0-*
Handle sets for TEDEE Smart Lock	1	K-U7292-T1-0-*
* = Color		PU = Packaging Unit
5 = Dark Bronze PC, 6 = Black PC,		

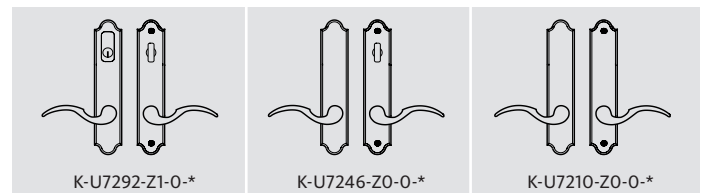
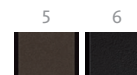

- Stainless steel set screw on levers to secure spindle
- Patented handle clipping system
- Kit for 1 3/4" and 2 1/4" thick doors
- US-cylinder above handle
- Compatible with TEDEE smart locks



### Additional information

- Unassembled solid brass trim kits
- US-cylinder with standard 5 pins Schlage "C" keyway
- 90° locking with thumb-turn
- Self-centering 8mm spindle



### Additional information

- Unassembled zamac trim kits
- US-cylinder with standard 5 pins Schlage "C" keyway
- 90° locking with thumb-turn
- Self-centering 8mm spindle

### TORINO Solid Brass Trim Kits

Description	PU	Part Number
Handle sets for active doors with US-cylinder	1	K-U6492-01-0-*
Handle sets for semi-active doors	1	K-U6446-00-0-*
Handle sets for fixed doors	1	K-U6410-00-0-*
Handle sets for TEDEE Smart Lock	1	K-U6492-T1-0-*
* = Color		PU = Packaging Unit
01 = Satin Chrome, 03 = Polished Brass, 04 = Antique Brass, 05 = Oil Rubbed Bronze, 11 = Satin Nickel, 28 = Pewter		

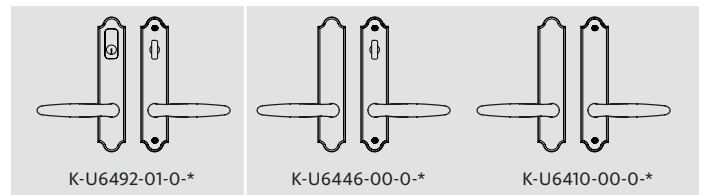
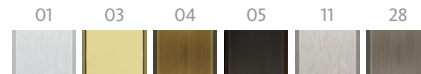

- Stainless steel set screw on levers to secure spindle
- Patented handle clipping system
- Kit for 1 3/4" and 2 1/4" thick doors
- US-cylinder above handle
- Compatible with TEDEE smart locks

### TORINO Zamac Trim Kits

Description	PU	Part Number
Handle sets for active doors with US-cylinder	1	K-U7492-Z1-0-*
Handle sets for semi-active doors	1	K-U7446-Z0-0-*
Handle sets for fixed doors	1	K-U7410-Z0-0-*
Handle sets for TEDEE Smart Lock	1	K-U7492-T1-0-*
* = Color		PU = Packaging Unit
01 = Satin Chrome, 5 = Dark Bronze, 6 = Black, 28 = Pewter		

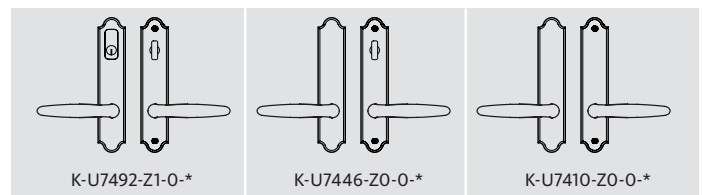
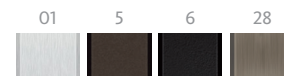

- Stainless steel set screw on levers to secure spindle
- Patented handle clipping system
- Kit for 1 3/4" and 2 1/4" thick doors
- US-cylinder above handle
- Compatible with TEDEE smart locks

# VENICE Handle & 45mm Plate



### Additional information

- Unassembled solid brass trim kits
- US-cylinder with standard 5 pins Schlage "C" keyway
- 90° locking with thumb-turn
- Self-centering 8mm spindle

### VENICE Solid Brass Trim Kits

Description	PU	Part Number
Handle sets for active doors with US-cylinder	1	K-U6692-01-0-*
Handle sets for semi-active doors	1	K-U6646-00-0-*
Handle sets for fixed doors	1	K-U6610-00-0-*
Handle sets for TEDEE Smart lock	1	K-U6692-T1-0-*
* = Color		PU = Packaging Unit
01 = Satin Chrome, 03 = Polished Brass, 04 = Antique Brass, 05 = Oil Rubbed Bronze, 11 = Satin Nickel, 28 = Pewter		

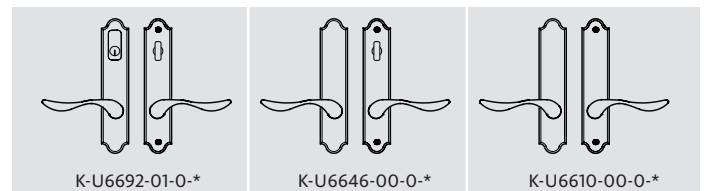
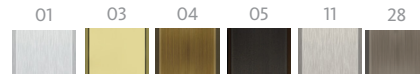

- Stainless steel set screw on levers to secure spindle
- Patented handle clipping system
- Kit for 1 3/4" and 2 1/4" thick doors
- US-cylinder above handle
- Compatible with TEDEE smart locks



### Additional information

- Unassembled zamac trim kits
- US-cylinder with standard 5 pins Schlage "C" keyway
- 90° locking with thumb-turn
- Self-centering 8mm spindle

### VENICE Zamac Trim Kits

Description	PU	Part Number
Handle sets for active doors with US-cylinder	1	K-U7692-Z1-0-*
Handle sets for semi-active doors	1	K-U7646-Z0-0-*
Handle sets for fixed doors	1	K-U7610-Z0-0-*
Handle sets for TEDEE Smart Lock	1	K-U7692-T1-0-*
* = Color		PU = Packaging Unit
01 = Satin Chrome, 5 = Dark Bronze PC, 6 = Black PC, 28 = Pewter		

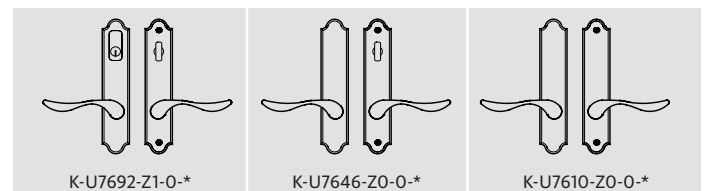
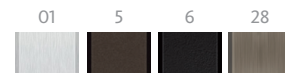

- Stainless steel set screw on levers to secure spindle
- Patented handle clipping system
- Kit for 1 3/4" and 2 1/4" thick doors
- US-cylinder above handle
- Compatible with TEDEE smart locks

# ROMA Handle & 55mm Plates



### Additional information

- Unassembled solid brass trim kits
- US-cylinder with standard 5 pins Schlage "C" keyway
- 90° locking with thumb-turn
- Self-centering 8mm spindle

### ROMA Solid Brass Trim Kits

Description	PU	Part Number
Handle sets for active doors with US-cylinder	1	K-U4092-01-0-*
Handle sets for semi-active doors	1	K-U4046-00-0-*
Handle sets for fixed doors	1	K-U4010-00-0-*
Handle sets for TEDEE Smart Lock	1	K-U4092-T1-0-*
* = Color		PU = Packaging Unit

11 = Satin Nickel, 28 = Pewter

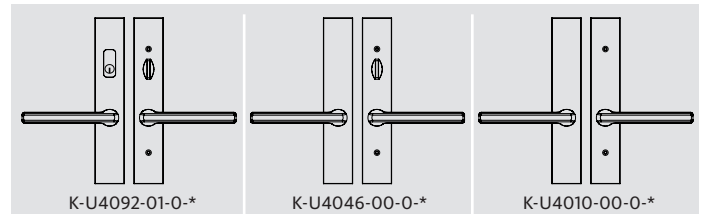

- Stainless steel set screw on levers to secure spindle
- Patented handle clipping system
- Kit for 1 3/4" and 2 1/4" thick doors
- US-cylinder above handle
- Compatible with TEDEE smart locks



### Additional information

- Unassembled zamac trim kits
- US-cylinder with standard 5 pins Schlage "C" keyway
- 90° locking with thumb-turn
- Self-centering 8mm spindle

### ROMA Zamac Trim Kits

Description	PU	Part Number
Handle sets for active doors with US-cylinder	1	K-U9092-Z1-0-*
Handle sets for semi-active doors	1	K-U9046-Z0-0-*
Handle sets for fixed doors	1	K-U9010-Z0-0-*
Handle sets for TEDEE smart lock	1	K-U9092-T1-0-*
* = Color		PU = Packaging Unit

5 = Dark Bronze, 6 = Black PC

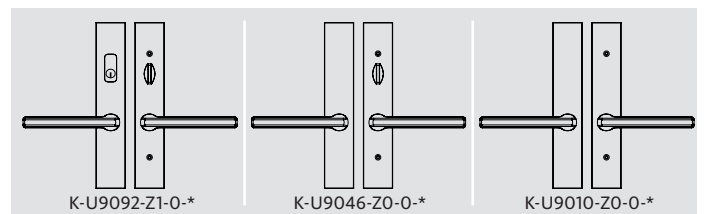
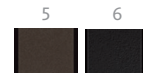

- Stainless steel set screw on levers to secure spindle
- Patented handle clipping system
- Kit for 1 3/4" and 2 1/4" thick doors
- US-cylinder above handle
- Compatible with TEDEE smart locks

# BERLIN Handle & 65mm Plates



## BERLIN Solid Brass Trim Kits

Description	PU	Part Number
Handle sets for active doors with US-cylinder	1	K-U2592-01-0-*
Handle sets for semi-active doors	1	K-U2546-00-0-*
Handle sets for fixed doors	1	K-U2510-00-0-*
Handle sets for TEDEE smart lock	1	K-U2592-T1-0-*
* = Color		PU = Packaging Unit

11 = Satin Nickel, 28 = Pewter

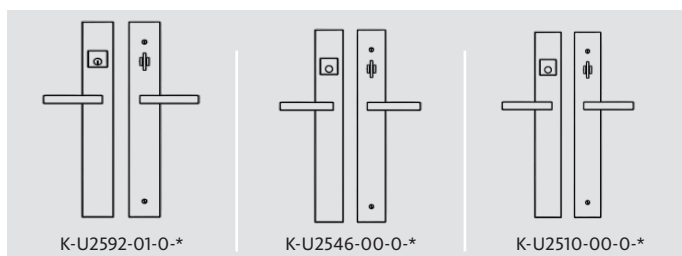
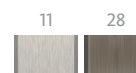

### Additional information

- Unassembled Solid Brass trim kits
- US-cylinder with standard 5 pins Schlage "C" keyway
- New snapping mechanism for the 90° locking with thumb-turn
- Self-centering 8mm spindle
- Stainless steel set screw on levers to secure spindle
- Patented handle clipping system
- Kit for 1 3/4" and 2 1/4" thick doors
- US-cylinder above handle
- Compatible with TEDEE smart locks

- Active trim kits are converted to Semi-Active and Dummy using a pre-assembled cylinder plug and screw-in Dummy brackets (included in the kits)
- Minimum backset required: 50mm



#### Additional information

- Unassembled Zamac trim kits
- US-cylinder with standard 5 pins Schlage "C" keyway
- New snapping mechanism for the 90° locking with thumb-turn
- Self-centering 8mm spindle
- Stainless steel set screw on levers to secure spindle
- Patented handle clipping system
- Kit for 1 3/4" and 2 1/4" thick doors
- US-cylinder above handle
- Compatible with TEDEE smart locks

#### BERLIN Zamac Trim Kits

Description	PU	Part Number
Handle sets for active doors with US-cylinder	1	K-U8592-Z1-0-*
Handle sets for semi-active doors	1	K-U8546-Z0-0-*
Handle sets for fixed doors	1	K-U8510-Z0-0-*
Handle sets for TEDEE smart lock	1	K-U8592-T1-0-*
* = Color		PU = Packaging Unit
5 = Dark Bronze PC, 6 = Black PC		

5      6

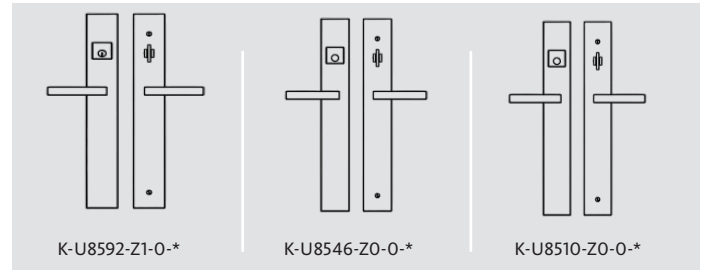
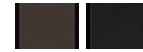

- Active trim kits are converted to Semi-Active and Dummy using a pre-assembled cylinder plug and screw-in Dummy brackets (included in the kits)
- Minimum backset required: 50mm

# BELCANTO Handles & US Rosettes

for Door Lock



### US rosettes

Description	PU	Part Number
US lock kit for DB	1	K-C0370-00-0-*
US lock cyl. kit without knob for TEDEE Smart Lock	1	K-C0370-T1-0-*

\* = Color      PU = Packaging Unit

8B = Stainless Steel, 6V = Matte Black



### Additional information

- Made of stainless steel
- Fastening kit included for 1 3/4" and 2 1/4" doors
- Foam gasket
- Compatible with smart lock TEDEE Pro
- For doors thicker than 2 1/4" up to 2 3/4" use M5 x 80mm (not included) and 90mm cylinder (6-C0971-90-0-1)
- For doors thicker than 2 3/4" up to 3" use M5 x 90mm (not included) and 90mm cylinder (6-C0971-90-0-1)
- US lock cyl. kit for Smart Lock comes without knob and allen key



### Belcanto Handle Set

Description	PU	Part Number
Kit of inside and outside handles	1	K-C9071-00-0-*

\* = Color      PU = Packaging Unit

8B = Stainless Steel, 6= Black , 6V = Matte Black

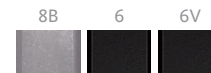

### Additional information

- Handles and Rosettes made of stainless steel
- Fastening kit included for 1 3/4" and 2 1/4" doors
- Fixed lever spring loaded - can't be lifted
- 8mm square spindle x 110 mm included
- Concealed fixing screws
- Compatible with smart lock TEDEE Pro
- For doors 3" use screws (9-C0570-90-0-1) and 130mm spindle (9-U8100-30-0-8)

# VENTO Handles

for Door Lock

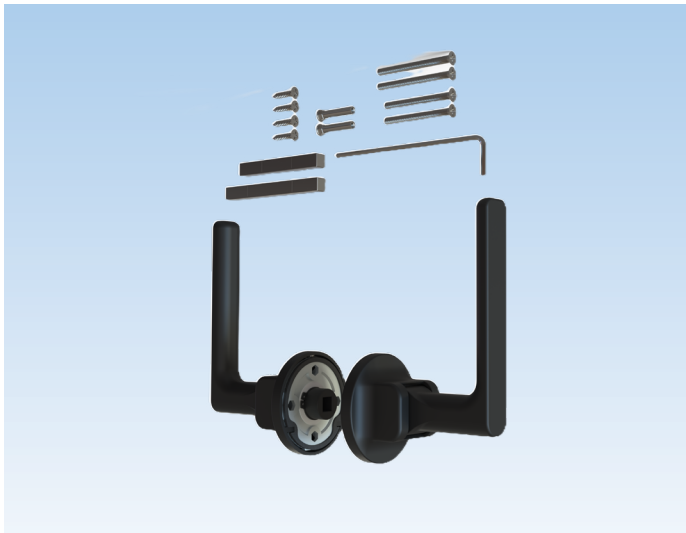
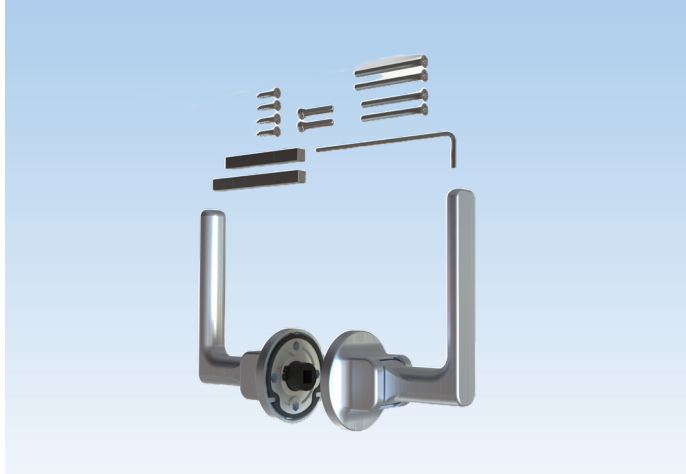

## VENTO Handle Set

Description	PU	Part Number
Kit of inside and outside handles	1	K-C0360-00-0-*
* = Color		PU = Packaging Unit

8B = Stainless Steel, 6V = Matte Black



### Additional information

- Handles and Rosettes made of stainless steel
- Foam gasket
- 8mm square spindle x 65 mm included (for 1 3/4" doors)
- 8mm square spindle x 78 mm included (for 2 1/4" doors)
- Concealed fixing screws
- Compatible with smart lock (TEDEE Pro)
- Should be ordered with K-C0370-00-0-\* - US rosette for N-A configuration

# Smart locks

for Door Lock

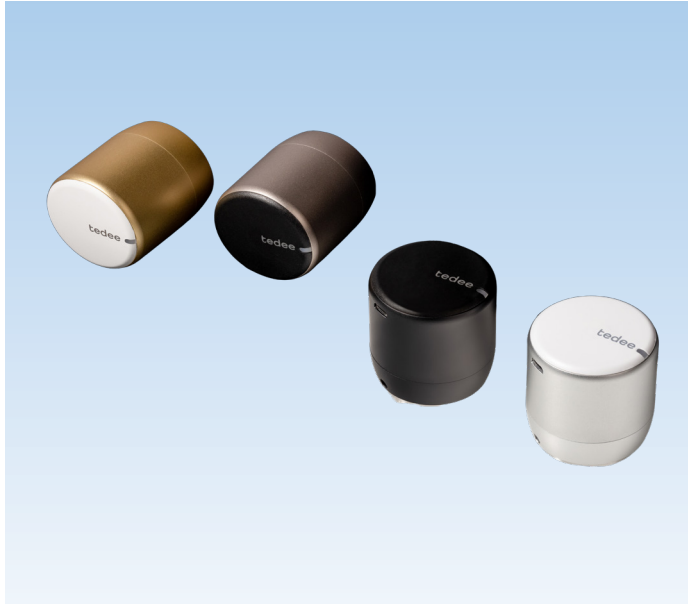

### Smart lock

Description	PU	Part Number
TEDEE PRO Smart Lock	1	6-C9370-00-0-*
* = Color		PU = Packaging Unit

1 = Silver, 6 = Black , 73 = White Gold , 61 = Black Grey



### Additional information

- Rechargeable 3000 mAh LiPo battery (included)
- Bluetooth BLE 5.0 2,4 GHz (TEDEE app) and Internet connection
- Security TLS 1.3
- Compatible with all Ferco handles (Lever & Gripset)



### TEDEE Smart lock remote access (Wi-Fi)

Description	PU	Part Number
TEDEE Smart Bridge	1	6-C9382-00-0-7
		PU = Packaging Unit

### Additional information

- Dimensions 63.5 x 63.5 x 28 mm / Weight 51.6g
- Power connection socket plug (included) or micro-USB (cable not included)
- Wi-Fi 2.4 GHz and 5.0 GHz
- Bluetooth 5.0 2.4 GHz
- Security TLS 1.3
- Compatible with TEDEE smart lock 6-C9370-00-0-X and Bluetooth Keypad 6-C9387-00-0-6
- Works with smart home systems
- Up to 5 Smart Locks can be controlled (Bluetooth Range)



### Bluetooth keypad 2.0

Description	PU	Part Number
TEDEE Keypad 2.0	1	6-C9387-01-0-*
* = Color		PU = Packaging Unit

6 = Black, 7 = White

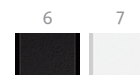

#### Additional information

- 3 X AAA batteries (included)
- Bluetooth 5.0 2,4 GHz
- Security TLS 1.3
- Up to 100 unique PINS
- Backlighted buttons, Sound signal, Bell button and more
- IP65 protection class
- Compatible with TEDEE smart lock 6-9370-00-0-X and bridge 6-C9382-00-0-7
- Finger print activated



### TEDEE Door sensor

Description	UE	Part Number
TEDEE Door Sensor	1	6-C9390-00-0-*
* = Color		PU = Packaging Unit

6 = Black, 7 = White



#### Additional information

- Sensor Dimensions 30 × 64 × 14 mm
- Magnet Dimensions 17 × 64 × 7 mm
- Power Supply CR2032 battery
- 2.4 GHz to 2.483 GHz (Max output power: 8 dBm)
- 5°C to 50°C (indoor only)



### Micro USB Cable

Description	UE	Part Number
Micro USB Cable for TEDEE Lock	1	6-C9377-00-0-0
PU = Packaging Unit		



### Spare cap for TEDEE lock

Description	PU	Part Number
Blank front button cover for TEDEE PRO	1	6-C9353-00-0-*
* = Color		PU = Packaging Unit

6V = Matte Black, 7 = White



### Additional information

- Compatible with TEDEE PRO

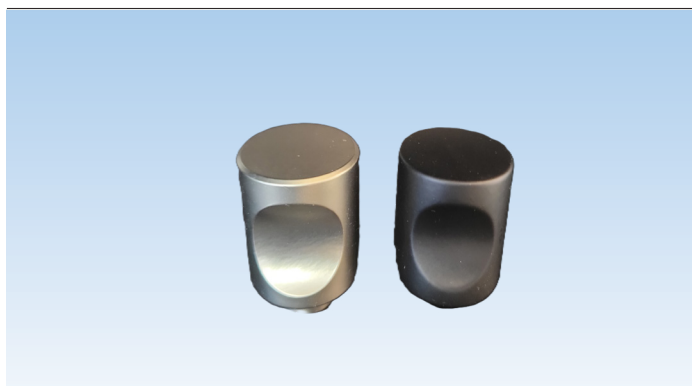

Knob for Profile cylinders for smart locks TEDEE		
Description	UE	Part Number
Knob for TEDEE Cylinder	1	6-U7359-00-0-*
		PU = Packaging Unit

11 = Satin Nickel, 6V = Matte Black



### Additional information

- Used during door installation or servicing to prevent damage
- Replaces the TEDEE if necessary
- Compatible with TEDEE smart cylinders

# Strike Plates

for Door Lock

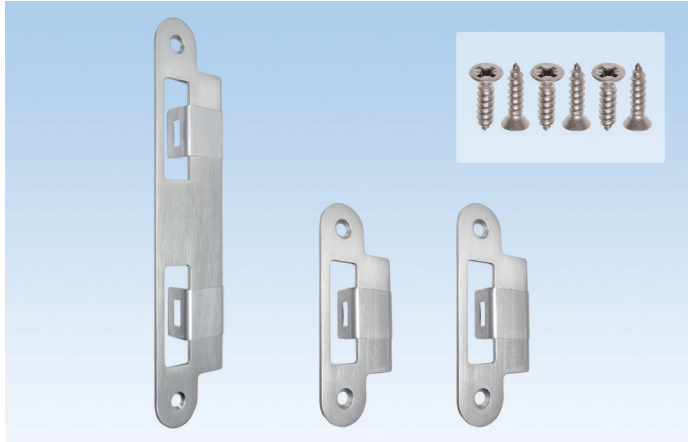

### Bag of Strike Plates

Description	PU	Part Number
Bag of strike plates for 45mm (1 3/4") thick doors	50	K-C4774-45-0-*
Bag of strike plates for 57mm (2 1/4") thick doors	50	K-C4775-57-0-*
* = Color		PU = Packaging Unit
03 = Polished Brass, 04 = Antique Brass, 5 = Dark Bronze, 6 = Black, 11 = Satin Nickel, 28 = Pewter		

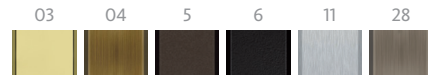

### Additional information

- Solid brass (03, 04, 28) or stainless steel (5, 6, 11)
- Bag contains:
  - 1 middle striker with extended lip and clear protective film
  - 2 top and bottom strikers with extended lip and clear protective film
  - 6 screws
- Non-handed
- Available in handle matching finishes
- For use with GU-SECURY Automatic door locks

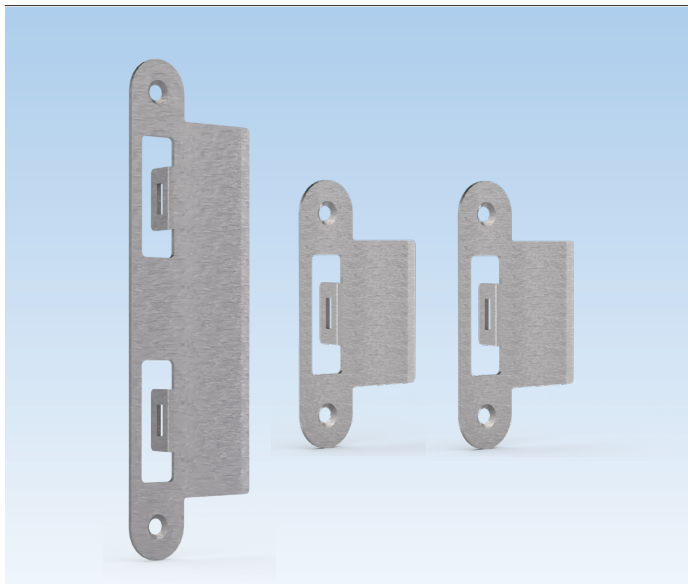

Description	PU	Part Number
Bag of strike plates for 76mm (3") thick doors	1	K-C4777-59-0-*
* = Color		PU = Packaging Unit

8B = Stainless Steel, 6 = Black

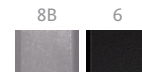

### Additional information

- Made in stainless steel
- Bag contains:
  - 1 middle striker with extended lip
  - 2 top and bottom strikers with extended lip
- Non-handed
- For use with GU-SECURY Automatic door locks
- Six #8 x 5/8 FH/PH screws included

# Strike Plates

for Door Lock

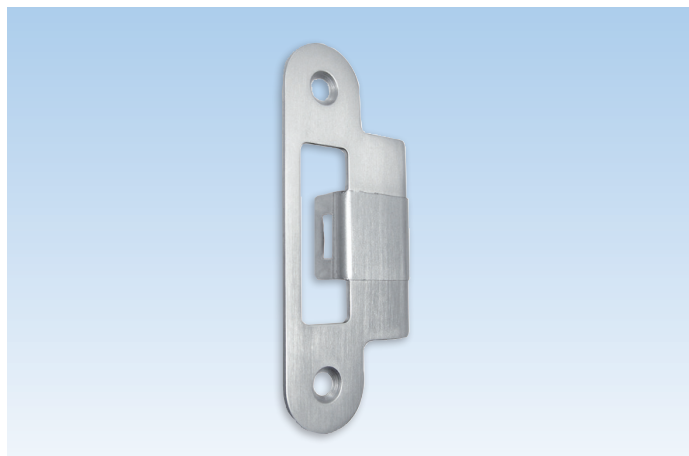

### Top and Bottom Striker with Extended Lip

Description	PU	Part Number
Latchbolt strike plate for 45mm (1 3/4") thick doors	10	9-C4776-45-0-*
Latchbolt strike plate for 57mm (2 1/4") thick doors	10	9-C4776-57-0-*
* = Color		PU = Packaging Unit
03 = Polished Brass, 04 = Antique Brass, 5 = Dark Bronze, 6 = Black, 11 = Satin Nickel, 28 = Pewter		

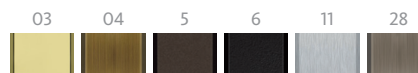

### Additional information

- Solid brass (03, 04, 28 ) or stainless steel (5, 6, 11 )
- Non-handed
- With clear protective film
- Available in handle matching finishes
- Two #8 x 5/8 FH/PH screws included
- For use with GU-SECURY Automatic door lock



### Middle Striker with Extended Lip

Description	PU	Part Number
Latch and deadbolt strike plate for 45mm (1 3/4") thick doors	10	9-C4777-45-0-*
Latch and deadbolt strike plate for 57mm (2 1/4") thick doors	10	9-C4777-57-0-*
* = Color		PU = Packaging Unit
03 = Polished Brass, 04 = Antique Brass, 5 = Dark Bronze, 6 = Black, 11 = Satin Nickel, 28 = Pewter		

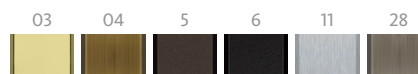

### Additional information

- Solid brass (03, 04, 28 ) or stainless steel (5, 6, 11 )
- Non-handed
- With clear protective film
- Available in handle matching finishes
- Two #8 x 5/8 FH/PH screws included
- For use with GU-SECURY SH2, S-Bolt, Automatic and mortise door locks

# Strike Plates

for Door Lock

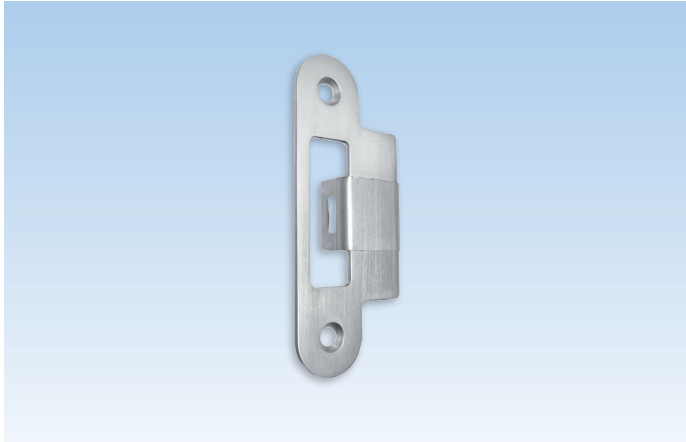

### Top and Bottom Striker with Extended Lip

Description	PU	Part Number
Latchbolt strike plate for 76mm (3") thick doors	10	9-C4716-59-0-*
* = Color		PU = Packaging Unit

8B = Stainless Steel, 6 = Black



#### Additional information

- Made in stainless steel
- Non-handed
- Two #8 x 5/8 FH/PH screws not included
- For use with GU-SECURY Automatic door lock



### Middle Striker with Extended Lip

Description	PU	Part Number
Latch and deadbolt strike plate for 76mm (3") thick doors	10	9-C4717-59-0-*
* = Color		PU = Packaging Unit

8B = Stainless Steel, 6 = Black

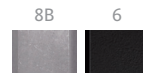

#### Additional information

- Made in stainless steel
- Non-handed
- Two #8 x 5/8 FH/PH screws not included
- For use with GU-SECURY Automatic door lock



### Torx 15 T-Key

Description	Color	PU	Part Number
Torx key	Steel	1	H-00346-15-0-0
PU = Packaging Unit			

#### Additional information

- Used for connecting SH2 and Automatic extensions



### 4mm Allen T-Key

Description	Color	PU	Part Number
Allen key	Steel	1	H-00345-04-0-0
PU = Packaging Unit			

#### Additional information

- Used for reversing Automatic latchbolts on GU-SECURY Automatic lock and extension



### Allen T-Key 2,5mm x 152mm

Description	Color	PU	Part Number
Allen key	Steel	1	6-C0560-20-0-0
* = Color		PU = Packaging Unit	

#### Additional information

- Ideal for properly tightening the set screw of Ferco handle-set



### PEEK Cream Cleaner

Description	PU	Part Number
100mL tube	1	
PU = Packaging Unit		

#### Additional information

- Cleans, polishes and protects the surface
- Successfully used to clean SS surfaces on handles and pullbars
- Leaves behind a light and invisible protective coating
- Available at Amazon , Candian Tire or other hardware store

03  
2



### Handle Set Color Chips

Description	PU	Part Number
Color chips	1	K-C4780-00-0-0
* = Color		PU = Packaging Unit
01 = Satin Chrome, 03 = Polished Brass, 04 = Antique Brass, 05 = Oil Rubbed Bronze, 5 = Dark Bronze, 6 = Black, 7 = White, 11 = Satin Nickel, 25 = Dark Bronze, 28 = Pewter		

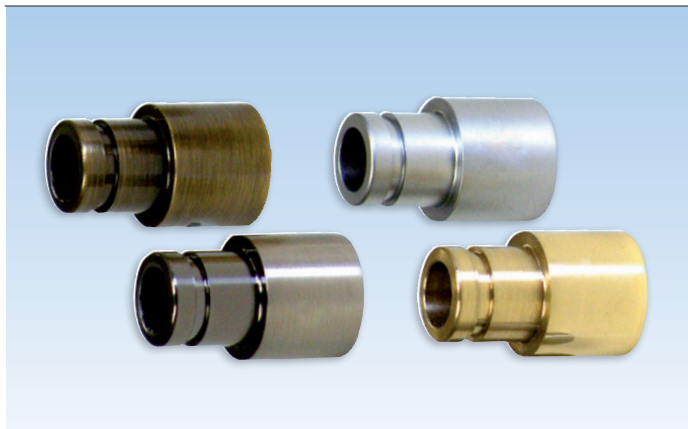
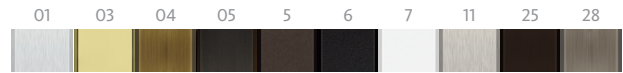

### Handle Extenders

Description	PU	Part Number
Handle extenders	1	9-C0695-00-0-*
* = Color		PU = Packaging Unit
01 = Satin Chrome, 03 = Polished Brass, 04 = Antique Brass, 05 = Oil Rubbed Bronze, 5 = Dark Bronze, 6 = Black, 25 = Dark Bronze, 28 = Pewter		

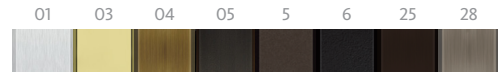

### Additional information

- Made of solid brass
- Use with our solid brass handle sets
- Extends 18mm

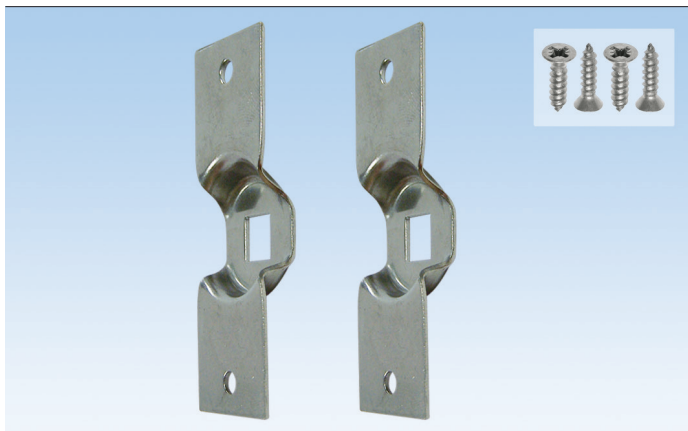

### Fixing Plate for Dummy Trim Kits

Description	PU	Part Number
Fixing plate used for fixed door handle	50	9-U8210-00-0-3
PU = Packaging Unit		

### Additional information

- Made of zinc plated steel
- Bag of two dummy plates and four #6 x 5/8" FH/PH screws
- Included with Handle Dummy kits
- Part not required for Active & Semi-Active handles
- Fixing in the door



### Fastening Screws

Description	Color	PU	Part Number
D1 screws	Stainless Steel	1000	9-C5362-32-0-8
PU = Packaging Unit			

### Additional information

- Stainless steel lock fastening screws
- Type D1 with self-drilling spiral point and high duplex thread with "Quadrex" socket
- Sharp tip for quick drive

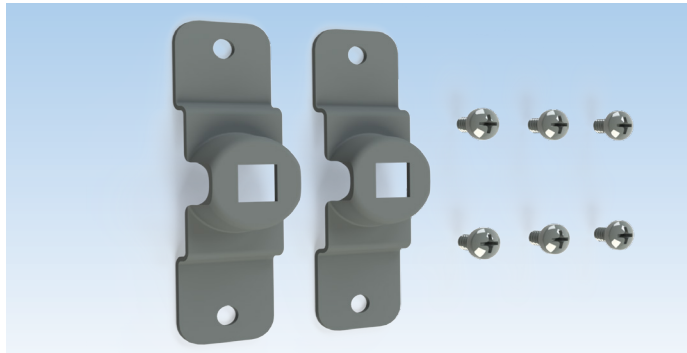

### Fixing Plate for Dummy Trim Kits with 55 and 65mm plate

Description	PU	Part Number
Fixing Plate for Dummy trim kits	1	K-C0973-00-0-0
PU = Packaging Unit		

#### Additional information

- Made of Zinc plated steel
- Bag of two dummy plates and six M4x5mm PH screws
- Included with 55 and 65mm plate Handle Dummy Kits
- Part not required for active and semi-active handles
- Fixing in the plate

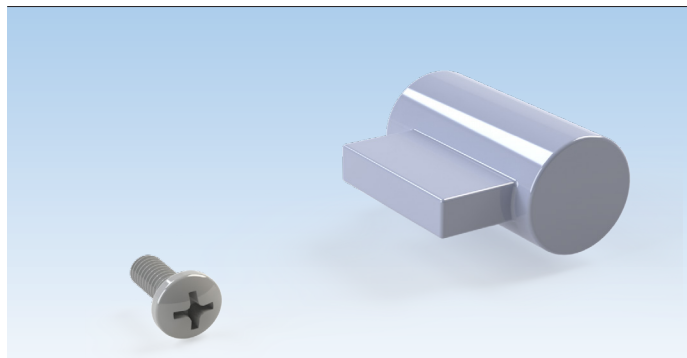

### Dummy conversion kit

Description	PU	Part Number
Dummy conversion kit	1	K-C0971-00-0-*
* = Color		PU = Packaging Unit

1 = Zinc, 25 = Dark Bronze



#### Additional information

- Made of Brass
- Bag of one dummy cylinder and one M4 x 10mm FH/PH screws
- Pre-installed with dummy & semi-active handles (65mm plate)
- Part not required for active handles

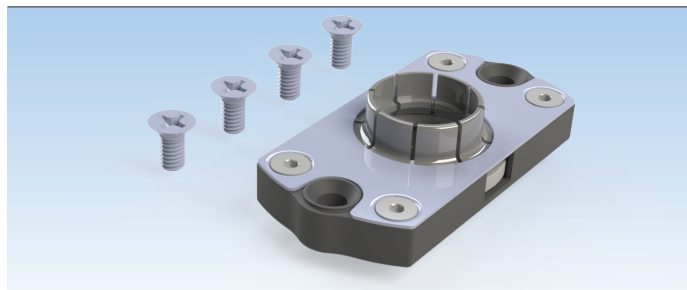

### Replacement Snap & Turn box

Description	PU	Part Number
Snap & Turn Box	1	K-C2057-00-0-0
PU = Packaging Unit		

#### Additional information

- Bag of one box and four M4 x 8mm FH/PH screws
- Included with handle sets with 65mm plate



### Screws for Strike Plates

Description	PU	Part Number
#8 x 5/8" (16mm) screws	10	K-C4763-16-6-*
* = Color		PU = Packaging Unit

03 = Polished Brass, 04 = Antique Brass, 5 = Dark Bronze, 6 = Black, 11 = Satin Nickel, 28 = Pewter

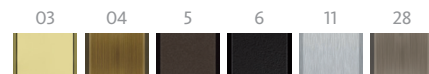

#### Additional information

- Bag of 6 screws for strike plates
- #8 x 5/8" FH/PH screws

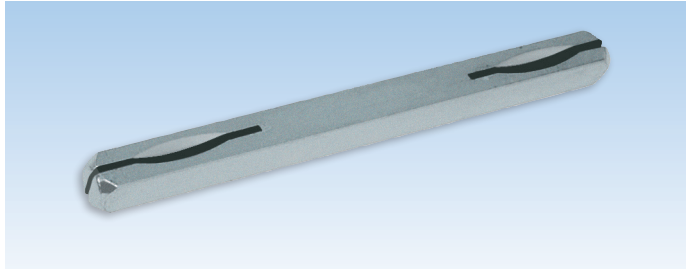

### 8mm Spindle

Description		PU	Part Number
8 x 8 x 120mm spindle for 41-57mm thick doors <i>(1 spindle is supplied with door handle kit)</i>	Zinc	10	9-U8100-20-0-8
8 x 8 x 130mm spindle for 57-76mm thick doors	Zinc	10	9-U8100-30-0-8
PU = Packaging Unit			

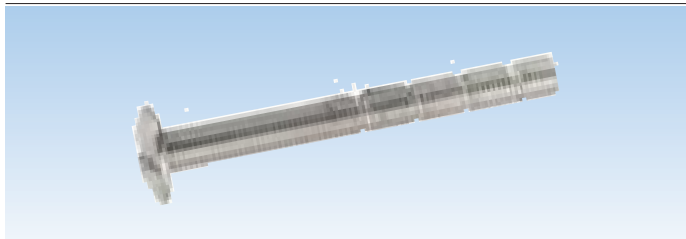

① For 41-76 mm thick doors

### Re-cuttable M5 Screw

Description	PU	Part Number
① M5 x 90mm screws <i>(2 screws are supplied with door handle kit)</i>	1	9-U2510-90-R-*
M5 x 110mm screws	1	9-U2510-10-R-*
* = Color		PU = Packaging Unit
01 = Satin Chrome, 03 = Polished Brass, 04 = Antique Brass, 05 = Oil Rubbed Bronze, 5 = Dark Bronze, 6 = Black, 7 = White, 11 = Satin Nickel, 25 = Dark Bronze, 28 = Pewter		

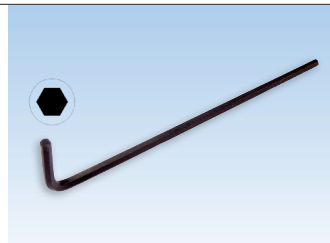

### Set Screw & Allen Key

Description	Color	PU	Part Number
M5 set screw <i>(2 screws are included with door handle kit)</i>	Stainless Steel	1	9-U6008-05-0-1
Allen key 2.5 x 20 x 100mm <i>(1 Allen key is supplied with door handle kit)</i>	Black	1	9-U0003-00-0-00
PU = Packaging Unit			

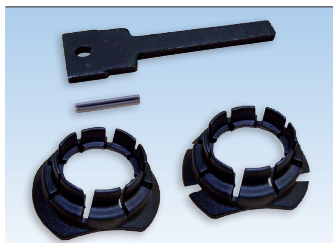

### Knob Tail Replacement Kits

Description	Color	PU	Part Number
48mm knob tail with snap rings	Black	1	K-C0600-48-0-0
72mm recutable knob tail with snap rings	Black	1	K-C0600-72-0-0
PU = Packaging Unit			

### Additional information

- Knob tail made of tempered steel
- Used for semi-active handle trim kits
- 48 mm for doors from 1 3/4" to 2 3/4"
- 72mm recutable for doors from 2 3/4" to 3 5/8"



### Snap Rings

Description	Color	PU	Part Number
Snap ring (Handles purchased before 2021)	Black	1	9-C0645-02-0-6A
Snap ring – low profile	Black	1	9-C0645-03-0-6
PU = Packaging Unit			



### Washers

Description	Color	PU	Part Number
Nylatron washer 0.25mm x 16mm (inner dia.)	Clear	1	9-C0647-25-0-0
Nylatron washer 0.5mm x 16mm (inner dia.)	Clear	1	9-C0647-50-0-0
Nylatron washer 1.0mm x 16mm (inner dia.)	Clear	1	9-C0647-10-0-0
PU = Packaging Unit			



### “O” Ring

Description	Color	PU	Part Number
“O” ring 1.5mm x 16mm (inner dia.)	Black	1	9-C0953-00-0-6
PU = Packaging Unit			



### Cylinders Schlage “C” Keyway

Description	Color	PU	Part Number
① Cylinder with 52mm tail and set of three keys	Zinc	1	6-C0971-52-0-1
	Brass	1	6-C0971-52-0-3
	Dark Bronze	1	6-C0971-52-0-25
② Cylinder with 64mm tail and set of three keys	Zinc	1	6-C0971-64-0-1
	Dark Bronze	1	6-C0971-64-0-25
③ Cylinder with 90 mm tail and set of three keys	Zinc	1	6-C0971-90-0-1
	Brass	1	6-C0971-90-0-3
	Dark Bronze	1	6-C0971-90-0-25
PU = Packaging Unit			

### Key Alike Cylinders Schlage “C” Keyway

Description	Color	PU	Part Number
① Cylinder with 52mm tail and set of three keys	Zinc	1	6-C0971-52-9-1
	Brass	1	6-C0971-52-9-3
	Dark Bronze	1	6-C0971-52-9-25
② Cylinder with 64mm tail and set of three keys	Zinc	1	6-C0971-64-9-1
	Dark Bronze	1	6-C0971-64-9-25
③ Cylinder with 90mm tail and set of three keys	Zinc	1	6-C0971-90-9-1
	Brass	1	6-C0971-90-9-3
	Dark Bronze	1	6-C0971-90-9-25
PU = Packaging Unit			

- ① For 41-57 mm thick doors with plate 30,45,55mm
- ② For 41-57 mm thick doors with plate 65mm
- ③ For 41-76 mm thick doors

Master Key : 9-C9990-CM-0-0  
Key blank : 9-C0974-02-0-0

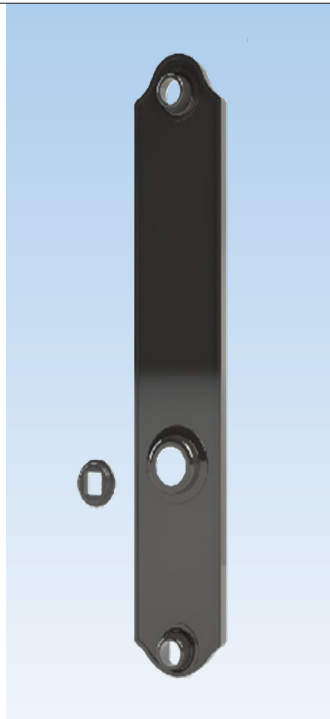
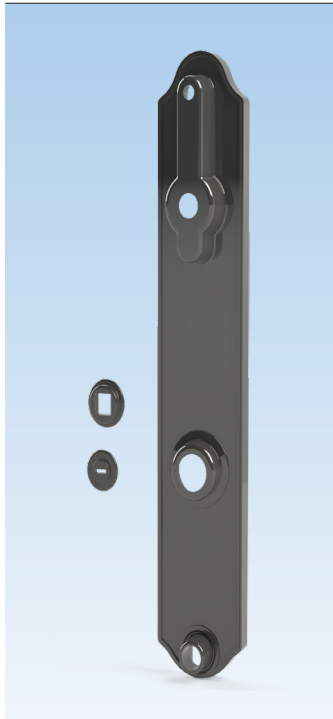

### Gasket 55mm

Description	Color	PU	Part Number
Gasket for active plate	Black	1	6-C0825-55-0-6
Gasket for inactive plate	Black	1	6-C0826-55-0-6
PU = Packaging Unit			

### Additional information

- Not compatible with Dummy Handle fixing Plates K-C0973-00-0-0. To use this product in a dummy handle configuration, use fixing plates 6-C0800-03-0-0

### Gasket 45mm

Description	Color	PU	Part Number
Gasket for active plate	Black	1	6-C0825-00-0-6
Gasket for inactive plate	Black	1	6-C0826-00-0-6
PU = Packaging Unit			



**Construction Handle Set**

Description	Color	PU	Part Number
Construction handle	Black	25	K-C9250-25-0-6
PU = Packaging Unit			

**Additional information**

- Reinforced nylon temporary door trim sets
- 8 x 8 x 90mm square spindle included
- 4.2 x 50mm screws included
- For 1 3/4" thick doors
- Locking/Unlocking from inside only



<b>Construction Key</b>			
Description	Color	PU	Part Number
Construction key	Black	10	9-U0001-01-0-0
PU = Packaging Unit			

**Additional information**

The construction key is available for those who prefer to install the decorative hardware trim and lever sets on doors after the construction has been completed. Installing the escutcheon plates and levers in the final stage of construction prevents the decorative trim from becoming scratched or damaged.

The construction key has been designed to accommodate multipoint door hardware (8mm square), tilt-turn hardware (7mm square) and lift-slide hardware (10mm square).



<b>Dust Cup without Edge – 15mm</b>			
Description	Color	PU	Part Number
Plastic cup	Black	10	9-C4765-0A-0-6
		100	9-C4765-1C-A-6
		500	9-C4765-5C-A-6
PU = Packaging Unit			

**Additional information**

- Dimensions:  
- Length: 62mm , Width: 19.5mm, Depth: 16mm



<b>Dust Cup Edge– 25mm</b>			
Description	Color	PU	Part Number
Plastic cup	Black	10	9-C4765-00-0-6
		100	9-C4765-1C-0-6
		500	9-C4765-5C-0-6
PU = Packaging Unit			

**Additional information**

- Use for latch and 2 automatic latches (optional)
- Dimensions:  
- Length: 62mm, Width: 19.5mm, Depth: 25.8mm

# Handle Display

for Lever Handle



### Handle Display with Lever Handles

Description	PU	Part Number
Handle display	1	6-C9618-00-0-0
* = Color		PU = Packaging Unit
01 = Satin Chrome, 03 = Polished Brass, 04 = Antique Brass, 05 = Oil Rubbed Bronze, 5 = Dark Bronze, 6 = Black, 11 = Satin Nickel, 28 = Pewter		

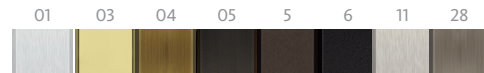

### Additional information

- To be used with 30, 45 and 55mm escutcheons and Capri, Torino, Allegro, Venice or Roma handles
- When ordering, please pick handle, plate and finish
- 7" x 7" x 17" 1/4 (17.75 cm x 17.75 cm x 44 cm)



### Handles Display with Lever Handles

Description	PU	Part Number
ROMA 55	1	K-C9608-A0-0-7
CAPRI	1	K-C9608-A2-0-7
TORINO 30	1	K-C9608-A4-0-7
BERLIN 65	1	K-C9608-A5-0-7
VENISE 45	1	K-C9608-A6-0-7
ALLEGRO 30	1	K-C9608-A8-0-7
Display Base	1	6-C9602-00-0-6
PU = Packaging Unit		

\* Models in this table are also available in French.

- Display delivered with wall mounted kit
- The display base is an option to place the unit on a desk, to be ordered separately
- 21" 1/2 x 32" x 12" (53.2 cm x 80.25 cm x 30.5 cm)

# Handle Display

for Lever Handle and Door Lock



## Handle Display with Door Lock and Handle

Description	PU	Part Number
Handle display - 45mm (1 3/4") thick	1	K-C9615-00-0-9
Handle display - Smart Lock TEDEE	1	K-C9619-SL-T-9
PU = Packaging Unit		

### Additional information

- Handle complete with lever handle and SECURY Automatic sample gear
- To be used with 30, 45 and 55mm escutcheons and Capri, Torino, Allegro, Venice or Roma handle
- Roma handle with TEDEE smart lock with K-C9619-SL-T-9
- When ordering, please add note for escutcheon, handle, and finish



03  
2



## Handle Display with US Rosette

Description	PU	Part Number
Handle display - 45mm (1 3/4") thick	1	K-C9622-00-0-9
Handle display - TEDEE Smart Lock	1	K-C9621-SL-T-9
PU = Packaging Unit		

### Additional information

- Handle complete with lever handle and SECURY Automatic sample gear
- To be used with US Rosette and Belcanto Handles
- US Rosette with TEDEE smart lock with K-C9621-SL-T-9
- When ordering, please add note for finish

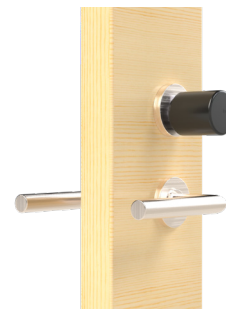

# Handle Display

for Lever Handle and Door Lock



## Handle Display with Door Lock and Handle

Description	PU	Part Number
Handle display – 65mm Plate	1	K-C9642-00-0-9
Handle display – 65 mm Plate with TEDEE Smart Lock	1	K-C9642-SL-T-9
PU = Packaging Unit		

### Additional information

- Handle complete with lever handle and SECURY Automatic sample gear
- 65 mm plate with TEDEE smart lock K-C9642-SL-T-9
- When ordering, please add note for finish



## VENTO Handle display US Pull bar 45

Description	PU	Part Number
VENTO Handle display US Pull bar 45	1	K-C9623-00-0-9
VENTO Handle display US Pull bar 45-TEDEE	1	K-C9623-00-T-9
PU = Packaging Unit		

### Additional information

- 7" x 7" x 31" 3/4 (17.75 cm x 17.75 cm x 80.65 cm)
- When ordering, please provide the finish to all components (SS or Matte Black)



WINDOW TECHNOLOGY  
 DOOR TECHNOLOGY  
 AUTOMATIC ENTRANCE SYSTEMS  
 BUILDING MANAGEMENT SYSTEMS



QUÉBEC / MARITIMES

Ferco Ferrures de Bâtiment Inc.  
 2000, Rue Berlier  
 Laval, QC H7L 4S4  
 Canada

T 450 973-1437  
 1 800 355-8810  
 F 450 973-7661  
 ferco@ferco.ca

ONTARIO / WESTERN PROVINCES

Ferco Architectural Hardware Inc.  
 T 905 282-9588  
 1 800 668-5310  
 F 905 282-9915

UNITED STATES

Ferco Architectural Hardware Inc.  
 T 1 800 927-1097  
 F 1 888 454-0161

[www.ferco.ca](http://www.ferco.ca)



Securing technology for you

