



DOOR TECHNOLOGY – ORDER CATALOG | SECTION 03.1



# GU-SECURY SH2 Door Lock & Lever Handle



Securing technology for you





# 03.1

## GU-SECURITY SH2 Door Lock & Lever Handle

### GU-SECURITY SH2

SH2 Door Lock.....	03.1.3
SH2 Extension.....	03.1.4

### HANDLES

Introduction.....	03.1.5
Finishes for handle set program.....	03.1.6

### 30mm Plate Series

ALLEGRO Trim Kits.....	03.1.8
TORINO Trim Kits.....	03.1.9
VENICE Trim Kits.....	03.1.10

### 45mm Plate Series

CAPRI Trim Kits.....	03.1.11
TORINO Trim Kits.....	03.1.12
VENICE Trim Kits.....	03.1.13

### 55mm Plate Series

ROMA Trim Kits.....	03.1.14
---------------------	---------

### 65mm Plate Series

BERLIN Trim Kits.....	03.1.15
BERLIN Trim Kits.....	03.1.16

### ACCESSORIES

Strike Plates.....	03.1.17
Accessories.....	03.1.20

Wood Mount Displays.....	03.1.29
--------------------------	---------

# GU-SECURITY SH2 Door Lock

with Latch, Deadbolt and 2 Hook Bolts



Unlocked



Locked

## GU-SECURITY SH2 Door Lock for Lever Handle

Description	Color	PU	Part Number
Door lock for 6' 8" doors with 45mm backset	Stainless Steel	5	6-33935-02-0-8B
Door lock for 8' doors with 45mm backset	Stainless Steel	5	6-33935-03-0-8B
Door lock for 6' 8" doors with 50mm backset	Stainless Steel	5	6-33935-04-0-8B
Door lock for 8' doors with 50mm backset	Stainless Steel	5	6-33935-05-0-8B
Door lock for 6' 8" doors with 60mm backset	Stainless Steel	5	6-33935-06-0-8B
Door lock for 8' doors with 60mm backset	Stainless Steel	5	6-33935-07-0-8B

PU = Packaging Unit

03  
1

### Get Hooked on Security!

GU-SECURITY SH2 locking system activates by closing the door and lifting the handle upwards. This action will engage the hooks into the strike plates which enhances the weathersealing properties and provides maximum security.

Turn the lever upwards to engage the hooks in the strike plates, then a 90-degree rotation of the key or knob engages the deadbolt and locks the entire system.

### Additional information

- 3-point, one piece locking system for 6' 8" and 8' doors
- Heavy duty mortise construction with reinforced lever return spring system
- Locking by US-cylinder with 90° turn of key or thumb-turn
- Lever controlled engaging and releasing of deadbolt, and two hook bolts
- Two hookbolt 1" (25mm) lock in an upward direction providing an anti-lift device
- 1" (25mm) increased resistance against pullout throw on deadbolt
- Non handed, latch with build-in failsafe (anti-slam) easily reversible
- 8mm square spindle
- 92mm centres (spindle to cylinder)
- Handle height variable (36" recommended)
- 16mm stainless steel faceplate with radius ends for easy installation and cleaner look
- Same hardware groove detail throughout our entire door lock program (jig, router base and bits available)
- Extension with additional lock point is available for doors taller than 8' (6-36062-04-0-8B)
- To be used with lever handle set (US-cylinder above handle)

# SH2 Extension

with Additional Hook Bolt

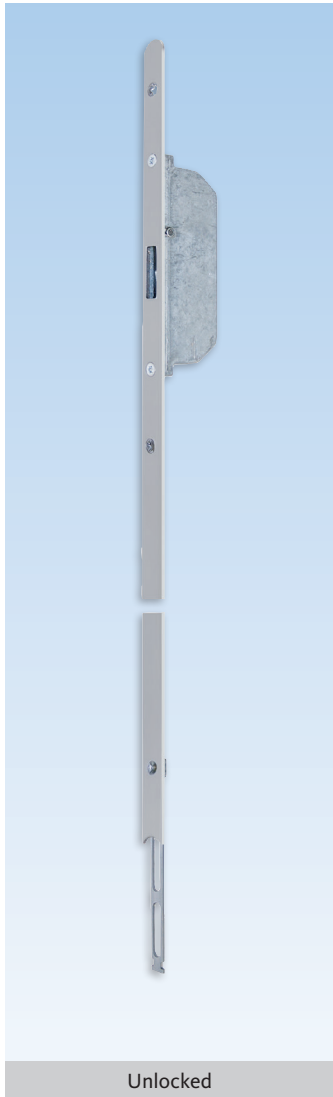

### Extension

Description	Color	PU	Part Number
525mm extension with rounded end	Stainless Steel	5	6-36062-04-0-8B
* = Color		PU = Packaging Unit	

### Additional information

- Steel horn with 1" (25mm) projection
- 16mm stainless steel faceplate with radius end for easy installation and cleaner look
- Additional locking point for doors taller than 8'
- To be used with GU-SECURITY SH2 door Locks (6-33935-XX-0-8B)



**Ferco lever handle sets** are uniquely designed to operate on multipoint door locks. Our handle sets withstand the rigorous everyday operational wear & tear of engaging or disengaging multiple lock points. **Our handle sets are designed for long term use!**

- **Patented handle snap-rings** allow for handles to be shipped non-handed. The manufacturer no longer has to worry about ordering left or right, and will save on inventory.
- **Handle setscrews to fasten spindles** combined with the snap-ring will ensure the handle will stay tight on the door for a long time.
- **Self centering 8mm split Spindle** to make sure it is always centered into the door.
- **Longer Screw ports on escutcheons:** Ferco has added an interior sleeve port that will guide the M5 mm screw straight to the opposing exterior screw port.
- **Exterior O-ring on handle shaft** to prevent water from entering around the exterior handle.
- **Washers between handle and escutcheon** making sure the handle operation is and remains smooth.
- **Escutcheon Foam gasket** to prevent air and cold.
- **Rubber gasket** (Order separately) to prevent air and water leakage around the exterior escutcheon.
- **Schlage Cylinder with one tail for both 1 ¾" and 2 ¼" thick doors**
- **M5 handle set screws to fasten the escutcheons** included in every handle set kit.
- **Handle above cylinder or handle below cylinder option**
- **FERCO handle sets available** in Solid Brass or economical zinc die-cast material with selections in many plate designs, lever styles and finishes.

# Finishes For Handle Set Program

- US-Cylinder Above Handle



	SOLID BRASS						ZAMAC					
	45mm PLATE			30mm PLATE			45mm PLATE			30mm PLATE		
	<b>CAPRI</b> K-U6292-01 K-U6246-00 K-U6210-00	<b>TORINO</b> K-U6492-01 K-U6446-00 K-U6410-00	<b>VENICE</b> K-U6692-01 K-U6646-00 K-U6610-00	<b>ALLEGRO</b> K-U3192-01 K-U3146-00 K-U3110-00	<b>TORINO</b> K-U3492-01 K-U3446-00 K-U3410-00	<b>VENICE</b> K-U3692-01 K-U3646-00 K-U3610-00	<b>CAPRI</b> K-U7292-Z1 K-U7246-Z0 K-U7210-Z0	<b>TORINO</b> K-U7492-Z1 K-U7446-Z0 K-U7410-Z0	<b>VENICE</b> K-U7692-Z1 K-U7646-Z0 K-U7610-Z0	<b>ALLEGRO</b> K-U5192-Z1 K-U5146-Z0 K-U5110-Z0	<b>TORINO</b> K-U5492-Z1 K-U5446-Z0 K-U5410-Z0	<b>VENICE</b> K-U5692-Z1 K-U5646-Z0 K-U5610-Z0
	01	01	01	01	01	01		01	01	01	01	01
Satin Chrome												
Polished Brass												
Antique Brass												
Oil Rubbed Bronze												
Dark Bronze PC												
Black PC												
White PC												
Satin Nickel												
Dark Bronze												
Pewter												







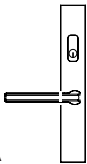
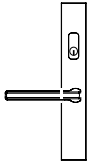

Colors on this document are graphic representation and may not be an exact match for the actual painted/plated hardware.  
For color selection, material samples are available on request.

\* information in this document can be modified without notice. Finishes Handle Sets Program\_03-2021

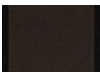
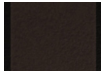
# Finishes For Handle Set Program

- US-Cylinder Above Handle



	SOLID BRASS 55mm PLATE	ZAMAC 55mm PLATE	SOLID BRASS 65mm PLATE	ZAMAC 65mm PLATE
	 <b>ROMA</b> K-U4092-01 K-U4046-00 K-U4010-00	 <b>ROMA</b> K-U9092-Z1 K-U9046-Z0 K-U9010-Z0	 <b>BERLIN</b> K-U2592-Z1 K-U2546-Z0 K-U2510-Z0	 <b>BERLIN</b> K-U8592-Z1 K-U8546-Z0 K-U8510-Z0
Satin Chrome				
Polished Brass				
Antique Brass				
Oil Rubbed Bronze				
Dark Bronze PC		5 		5 
Black PC		6 		6 
White PC				
Satin Nickel	11 		11 	
Dark Bronze				
Pewter	28 		28 	

03  
1

Colors on this document are graphic representation and may not be an exact match for the actual painted/plated hardware.  
For color selection, material samples are available on request.

# ALLEGRO Handles & 30mm Plates



## ALLEGRO Solid brass Trim Kits

Description	PU	Part Number
Handle sets for active doors with US-cylinder	1	K-U3192-01-0-*
Handle sets for semi-active doors	1	K-U3146-00-0-*
Handle sets for fixed doors	1	K-U3110-00-0-*
Handle sets for Tedee Smart Lock	1	K-U3192-T1-0-*
* = Color		PU = Packaging Unit
01 = Satin Chrome, 03 = Polished Brass, 04 = Antique Brass, 05 = Oil Rubbed Bronze, 11 = Satin Nickel, 28 = Pewter		

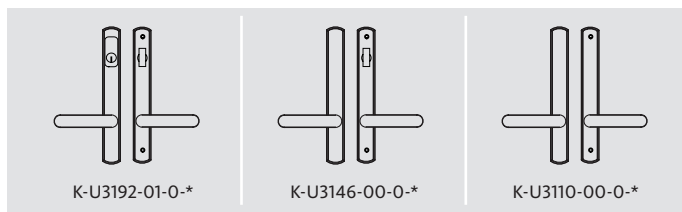
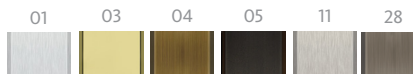

### Additional information

- Unassembled solid brass trim kits
- US-cylinder with standard 5 pins Schlage "C" keyway
- 90° locking with thumb-turn
- Self-centering 8mm spindle

- Stainless steel set screw on levers to secure spindle
- Patented handle clipping system
- Kit for 1 3/4" and 2 1/4" thick doors
- US-cylinder above handle
- Compatible with Tedee smart locks



## ALLEGRO Zamac Trim Kits

Description	PU	Part Number
Handle sets for active doors with US-cylinder	1	K-U5192-Z1-0-*
Handle sets for semi-active doors	1	K-U5146-Z0-0-*
Handle sets for fixed doors	1	K-U5110-Z0-0-*
Handle sets for Tedee Smart Lock	1	K-U5192-T1-0-*
* = Color		PU = Packaging Unit
01 = Satin Chrome, 5 = Dark Bronze PC, 6 = Black PC, 28 = Pewter		

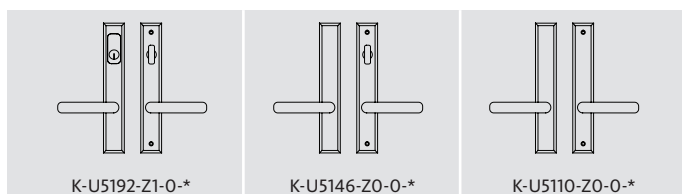
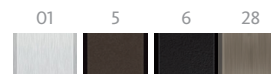

### Additional information

- Unassembled zamac trim kits
- US-cylinder with standard 5 pins Schlage "C" keyway
- 90° locking with thumb-turn
- Self-centering 8mm spindle

- Stainless steel set screw on levers to secure spindle
- Patented handle clipping system
- Kit for 1 3/4" and 2 1/4" thick doors
- US-cylinder above handle
- Compatible with Tedee smart locks

# TORINO Handles & 30mm Plates

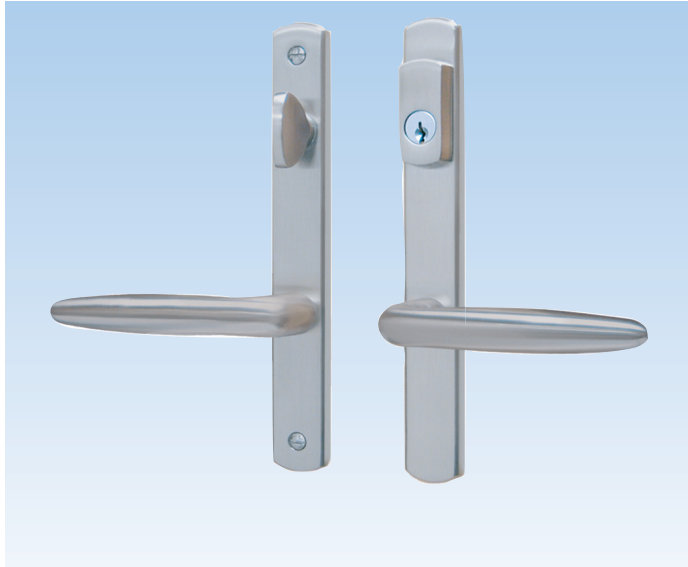

## TORINO Solid brass Trim Kits

Description	PU	Part Number
Handle sets for active doors with US-cylinder	1	K-U3492-01-0-*
Handle sets for semi-active doors	1	K-U3446-00-0-*
Handle sets for fixed doors	1	K-U3410-00-0-*
Handle sets for Tedee Smart Lock	1	K-U3492-T1-0-*

\* = Color      PU = Packaging Unit

01 = Satin Chrome, 03 = Polished Brass, 04 = Antique Brass, 05 = Oil Rubbed Bronze, 11 = Satin Nickel, 28 = Pewter

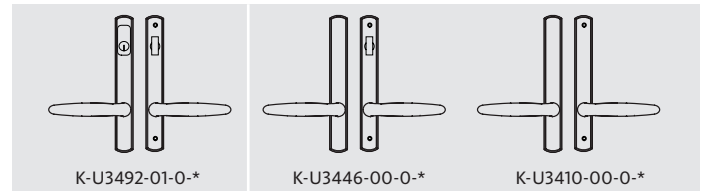
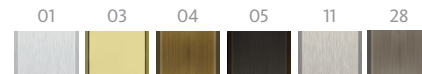

### Additional information

- Unassembled solid brass trim kits
- US-cylinder with standard 5 pins Schlage "C" keyway
- 90° locking with thumb-turn
- Self-centering 8mm spindle

- Stainless steel set screw on levers to secure spindle
- Patented handle clipping system
- Kit for 1 3/4" and 2 1/4" thick doors
- US-cylinder above handle
- Compatible with Tedee smart locks



## TORINO Zamac Trim Kits

Description	PU	Part Number
Handle sets for active doors with US-cylinder	1	K-U5492-Z1-0-*
Handle sets for semi-active doors	1	K-U5446-Z0-0-*
Handle sets for fixed doors	1	K-U5410-Z0-0-*
Handle sets for Tedee Smart Lock	1	K-U5492-T1-0-*

\* = Color      PU = Packaging Unit

01 = Satin Chrome, 5 = Dark Bronze PC, 6 = Black PC, 28 = Pewter

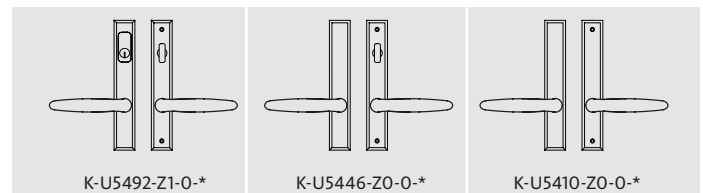
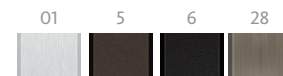

### Additional information

- Unassembled zamac trim kits
- US-cylinder with standard 5 pins Schlage "C" keyway
- 90° locking with thumb-turn
- Self-centering 8mm spindle

- Stainless steel set screw on levers to secure spindle
- Patented handle clipping system
- Kit for 1 3/4" and 2 1/4" thick doors
- US-cylinder above handle
- Compatible with Tedee smart locks

# VENICE Handle & 30mm Plate



### VENICE Solid Brass Trim Kits

Description	PU	Part Number
Handle sets for active doors with US-cylinder	1	K-U3692-01-0-*
Handle sets for semi-active doors	1	K-U3646-00-0-*
Handle sets for fixed doors	1	K-U3610-00-0-*
Handle sets for Tedee Smart Lock	1	K-U3692-T1-0-*
* = Color		PU = Packaging Unit
01 = Satin Chrome, 03 = Polished Brass, 04 = Antique Brass, 05 = Oil Rubbed Bronze, 11 = Satin Nickel, 28 = Pewter		

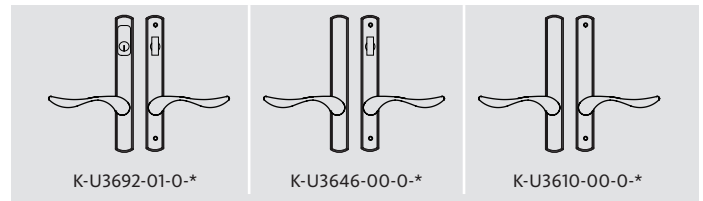
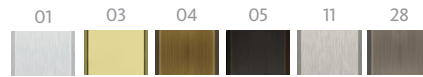

### Additional information

- Unassembled solid brass trim kits
- US-cylinder with standard 5 pins Schlage "C" keyway
- 90° locking with thumb-turn
- Self-centering 8mm spindle

- Stainless steel set screw on levers to secure spindle
- Patented handle clipping system
- Kit for 1 3/4" and 2 1/4" thick doors
- US-cylinder above handle
- Compatible with Tedee smart locks

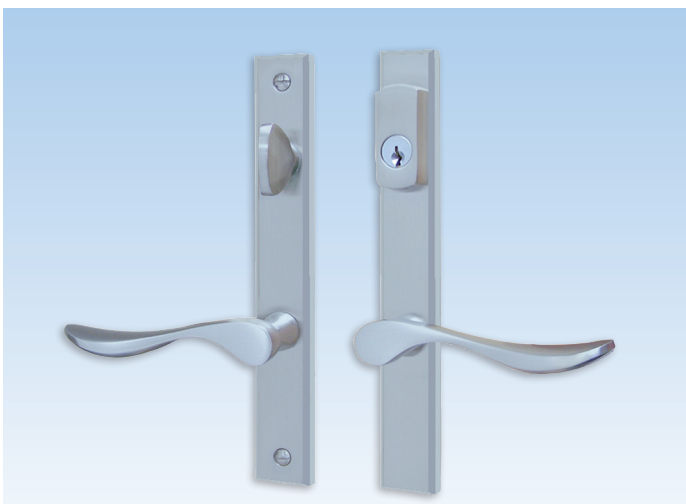

### VENICE Zamac Trim Kits

Description	PU	Part Number
Handle sets for active doors with US-cylinder	1	K-U5692-Z1-0-*
Handle sets for semi-active doors	1	K-U5646-Z0-0-*
Handle sets for fixed doors	1	K-U5610-Z0-0-*
Handle sets for Tedee Smart Lock	1	K-U5692-T1-0-*
* = Color		PU = Packaging Unit
01 = Satin Chrome, 5 = Dark Bronze PC, 6 = Black PC, 28 = Pewter		

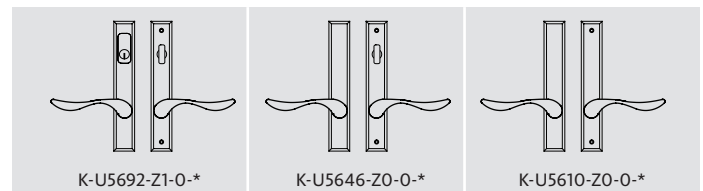
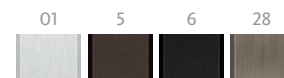

### Additional information

- Unassembled zamac trim kits
- US-cylinder with standard 5 pins Schlage "C" keyway
- 90° locking with thumb-turn
- Self-centering 8mm spindle

- Stainless steel set screw on levers to secure spindle
- Patented handle clipping system
- Kit for 1 3/4" and 2 1/4" thick doors
- US-cylinder above handle
- Compatible with Tedee smart locks



### CAPRI Solid Brass Trim Kits

Description	PU	Part Number
Handle sets for active doors with US-cylinder	1	K-U6292-01-0-*
Handle sets for semi-active doors	1	K-U6246-00-0-*
Handle sets for fixed doors	1	K-U6210-00-0-*
Handle sets for Tedee Smart Lock	1	K-U6292-T1-0-*
* = Color		PU = Packaging Unit
01 = Satin Chrome, 03 = Polished Brass, 04 = Antique Brass, 05 = Oil Rubbed Bronze, 11 = Satin Nickel, 28 = Pewter		

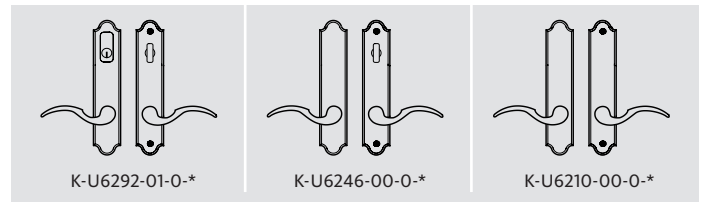
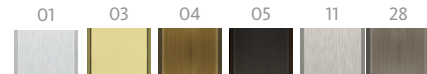

#### Additional information

- Unassembled solid brass trim kits
- US-cylinder with standard 5 pins Schlage "C" keyway
- 90° locking with thumb-turn
- Self-centering 8mm spindle

- Stainless steel set screw on levers to secure spindle
- Patented handle clipping system
- Kit for 1 3/4" and 2 1/4" thick doors
- US-cylinder above handle
- Compatible with Tedee smart locks



### CAPRI Zamac Trim Kits

Description	PU	Part Number
Handle sets for active doors with US-cylinder	1	K-U7292-Z1-0-*
Handle sets for semi-active doors	1	K-U7246-Z0-0-*
Handle sets for fixed doors	1	K-U7210-Z0-0-*
Handle sets for Tedee Smart Lock	1	K-U7292-T1-0-*
* = Color		PU = Packaging Unit
5 = Dark Bronze PC, 6 = Black PC		

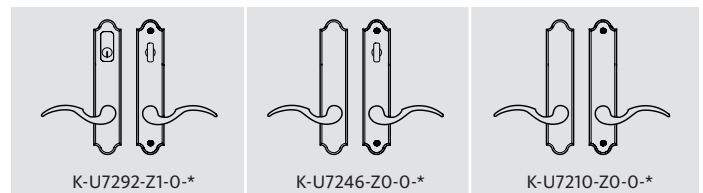
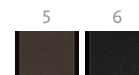

#### Additional information

- Unassembled zamac trim kits
- US-cylinder with standard 5 pins Schlage "C" keyway
- 90° locking with thumb-turn
- Self-centering 8mm spindle

- Stainless steel set screw on levers to secure spindle
- Patented handle clipping system
- Kit for 1 3/4" and 2 1/4" thick doors
- US-cylinder above handle
- Compatible with Tedee smart locks



### TORINO Solid Brass Trim Kits

Description	PU	Part Number
Handle sets for active doors with US-cylinder	1	K-U6492-01-0-*
Handle sets for semi-active doors	1	K-U6446-00-0-*
Handle sets for fixed doors	1	K-U6410-00-0-*
Handle sets for Tedee Smart Lock	1	K-U6492-T1-0-*

\* = Color      PU = Packaging Unit

01 = Satin Chrome, 03 = Polished Brass, 04 = Antique Brass,  
05 = Oil Rubbed Bronze, 11 = Satin Nickel, 28 = Pewter

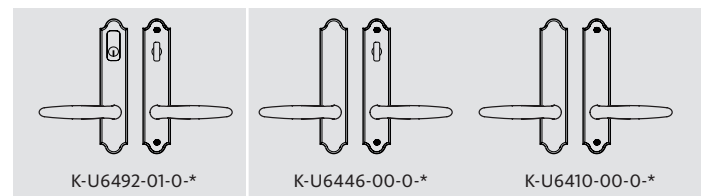
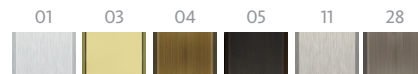

#### Additional information

- Unassembled solid brass trim kits
- US-cylinder with standard 5 pins Schlage "C" keyway
- 90° locking with thumb-turn
- Self-centering 8mm spindle

- Stainless steel set screw on levers to secure spindle
- Patented handle clipping system
- Kit for 1 3/4" and 2 1/4" thick doors
- US-cylinder above handle
- Compatible with Tedee smart locks



### TORINO Zamac Trim Kits

Description	PU	Part Number
Handle sets for active doors with US-cylinder	1	K-U7492-Z1-0-*
Handle sets for semi-active doors	1	K-U7446-Z0-0-*
Handle sets for fixed doors	1	K-U7410-Z0-0-*
Handle sets for Tedee Smart Lock	1	K-U7492-T1-0-*

\* = Color      PU = Packaging Unit

01 = Satin Chrome, 5 = Dark Bronze, 6 = Black, 28 = Pewter

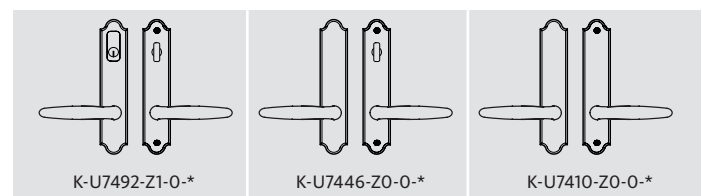
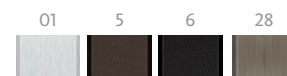

#### Additional information

- Unassembled zamac trim kits
- US-cylinder with standard 5 pins Schlage "C" keyway
- 90° locking with thumb-turn
- Self-centering 8mm spindle

- Stainless steel set screw on levers to secure spindle
- Patented handle clipping system
- Kit for 1 3/4" and 2 1/4" thick doors
- US-cylinder above handle
- Compatible with Tedee smart locks



### Additional information

- Unassembled solid brass trim kits
- US-cylinder with standard 5 pins Schlage "C" keyway
- 90° locking with thumb-turn
- Self-centering 8mm spindle



### Additional information

- Unassembled zamac trim kits
- US-cylinder with standard 5 pins Schlage "C" keyway
- 90° locking with thumb-turn
- Self-centering 8mm spindle

### VENICE Solid Brass Trim Kits

Description	PU	Part Number
Handle sets for active doors with US-cylinder	1	K-U6692-01-0-*
Handle sets for semi-active doors	1	K-U6646-00-0-*
Handle sets for fixed doors	1	K-U6610-00-0-*
Handle sets for Tedee Smart lock	1	K-U6692-T1-0-*
* = Color		PU = Packaging Unit
01 = Satin Chrome, 03 = Polished Brass, 04 = Antique Brass, 05 = Oil Rubbed Bronze, 11 = Satin Nickel, 25 = Dark Bronze, 28 = Pewter		

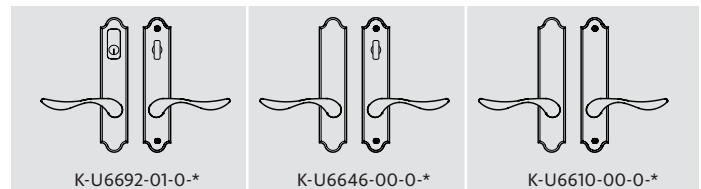
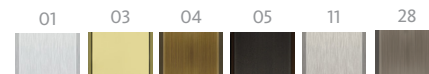

- Stainless steel set screw on levers to secure spindle
- Patented handle clipping system
- Kit for 1 3/4" and 2 1/4" thick doors
- US-cylinder above handle
- Compatible with Tedee smart locks

### VENICE Zamac Trim Kits

Description	PU	Part Number
Handle sets for active doors with US-cylinder	1	K-U7692-Z1-0-*
Handle sets for semi-active doors	1	K-U7646-Z0-0-*
Handle sets for fixed doors	1	K-U7610-Z0-0-*
Handle sets for Tedee Smart Lock	1	K-U7692-T1-0-*
* = Color		PU = Packaging Unit
01 = Satin Chrome, 5 = Dark Bronze PC, 6 = Black PC, 28 = Pewter		

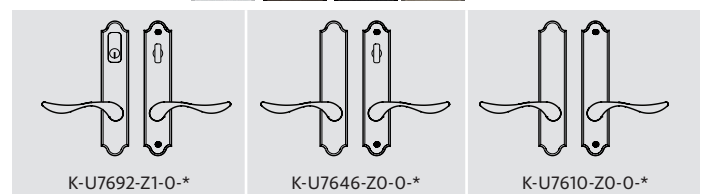
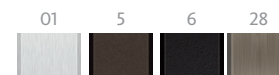

- Stainless steel set screw on levers to secure spindle
- Patented handle clipping system
- Kit for 1 3/4" and 2 1/4" thick doors
- US-cylinder above handle
- Compatible with Tedee smart locks

# ROMA Handle & 55mm Plates



### Additional information

- Unassembled solid brass trim kits
- US-cylinder with standard 5 pins Schlage "C" keyway
- 90° locking with thumb-turn
- Self-centering 8mm spindle

### ROMA Solid Brass Trim Kits

Description	PU	Part Number
Handle sets for active doors with US-cylinder	1	K-U4092-01-0-*
Handle sets for semi-active doors	1	K-U4046-00-0-*
Handle sets for fixed doors	1	K-U4010-00-0-*
Handle sets for Tedee Smart Lock	1	K-U4092-T1-0-*
* = Color		PU = Packaging Unit

11 = Satin Nickel, 28 = Pewter

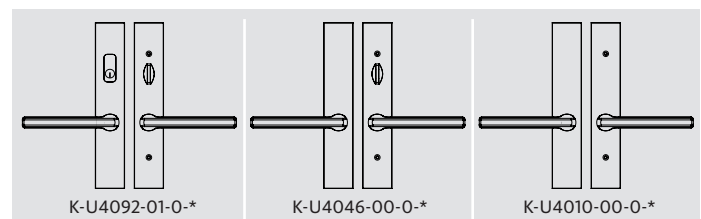
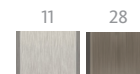

- Stainless steel set screw on levers to secure spindle
- Patented handle clipping system
- Kit for 1 3/4" and 2 1/4" thick doors
- US-cylinder above handle
- Compatible with Tedee smart locks



### Additional information

- Unassembled zamac trim kits
- US-cylinder with standard 5 pins Schlage "C" keyway
- 90° locking with thumb-turn
- Self-centering 8mm spindle

### ROMA Zamac Trim Kits

Description	PU	Part Number
Handle sets for active doors with US-cylinder	1	K-U9092-Z1-0-*
Handle sets for semi-active doors	1	K-U9046-Z0-0-*
Handle sets for fixed doors	1	K-U9010-Z0-0-*
Handle sets for Tedee smart lock	1	K-U9092-T1-0-*
* = Color		PU = Packaging Unit

5 = Dark Bronze, 6 = Black PC

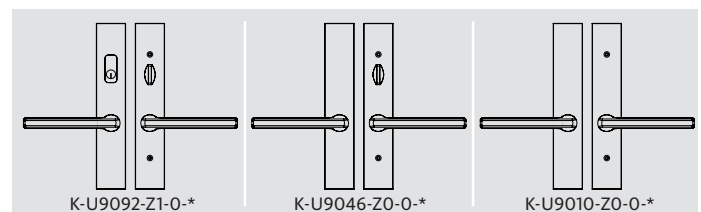

- Stainless steel set screw on levers to secure spindle
- Patented handle clipping system
- Kit for 1 3/4" and 2 1/4" thick doors
- US-cylinder above handle
- Compatible with Tedee smart locks

# BERLIN Handle & 65mm Plates



## BERLIN Solid Brass Trim Kits

Description	PU	Part Number
Handle sets for active doors with US-cylinder	1	K-U2592-01-0-*
Handle sets for semi-active doors	1	K-U2546-00-0-*
Handle sets for fixed doors	1	K-U2510-00-0-*
Handle sets for Tedee smart lock	1	K-U2592-T1-0-*
* = Color		PU = Packaging Unit

11 = Satin Nickel, 28 = Pewter

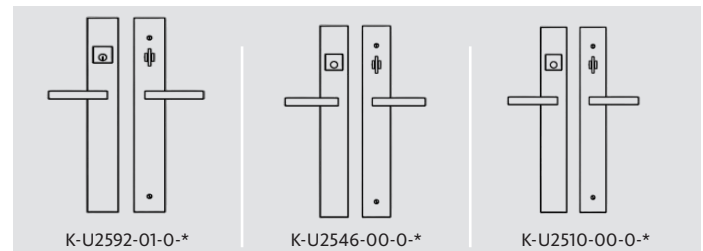
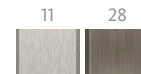

### Additional information

- Unassembled Solid Brass trim kits
- US-cylinder with standard 5 pins Schlage "C" keyway
- New snapping mechanism for the 90° locking with thumb-turn
- Self-centering 8mm spindle
- Stainless steel set screw on levers to secure spindle
- Patented handle clipping system
- Kit for 1 3/4" and 2 1/4" thick doors
- US-cylinder above handle
- Compatible with Tedee smart locks

- Active trim kits are converted to Semi-Active and Dummy using a pre-assembled cylinder plug and screw-in Dummy brackets (included in the kits)
- Minimum backset required: 50mm

# BERLIN Handle & 65mm Plates



### Additional information

- Unassembled Zamac trim kits
- US-cylinder with standard 5 pins Schlage "C" keyway
- New snapping mechanism for the 90° locking with thumb-turn
- Self-centering 8mm spindle
- Stainless steel set screw on levers to secure spindle
- Patented handle clipping system
- Kit for 1 3/4" and 2 1/4" thick doors
- US-cylinder above handle
- Compatible with Tedee smart locks

### BERLIN Zamac Trim Kits

Description	PU	Part Number
Handle sets for active doors with US-cylinder	1	K-U8592-Z1-0-*
Handle sets for semi-active doors	1	K-U8546-Z0-0-*
Handle sets for fixed doors	1	K-U8510-Z0-0-*
Handle sets for Tedee smart lock	1	K-U8592-T1-0-*
* = Color		PU = Packaging Unit
5 = Dark Bronze PC, 6 = Black PC		

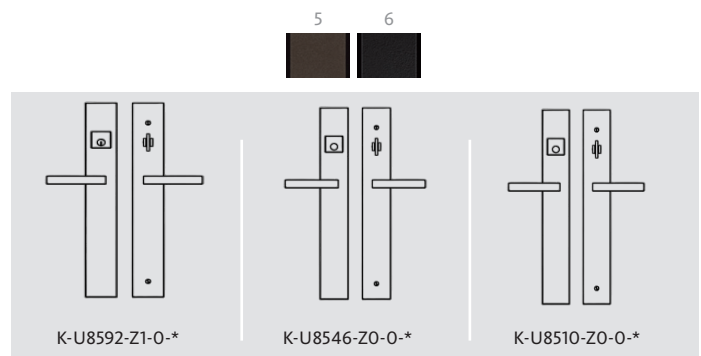

- Active trim kits are converted to Semi-Active and Dummy using a pre-assembled cylinder plug and screw-in Dummy brackets (included in the kits)
- Minimum backset required: 50mm

# Strike Plates

for Door Lock

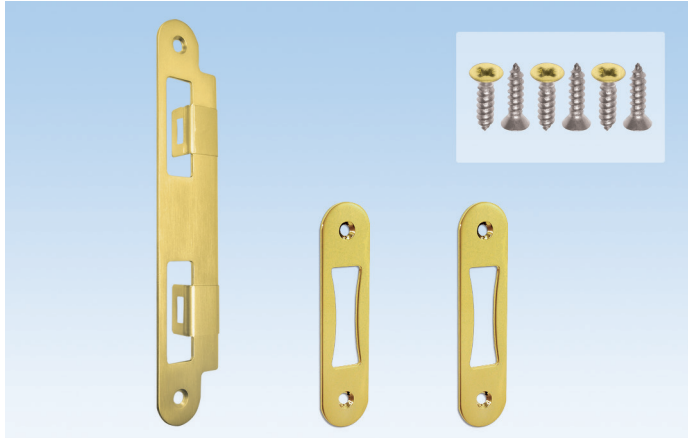

### Bag of Strike Plates

Description	PU	Part Number
Bag of strike plates for 45mm (1 3/4") thick doors	10	K-C4770-45-0-*
Bag of strike plates for 57mm (2 1/4") thick doors	10	K-C4770-57-0-*

\* = Color

PU = Packaging Unit

03 = Polished Brass, 04 = Antique Brass, 5 = Dark Bronze PC, 6 = Black PC, 11 = Satin Nickel, 25 = Dark Bronze, 28 = Pewter

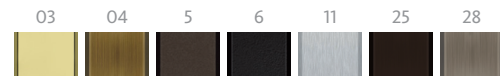

### Additional information

- Solid brass or stainless steel
- Bag contains:
  - 1 middle strike plate with extended lip and clear protective film
  - 2 top and bottom oval strike plates
  - 6 screws
- Non-handed
- Available in handle matching finishes
- For use with GU-SECURY SH2 door locks

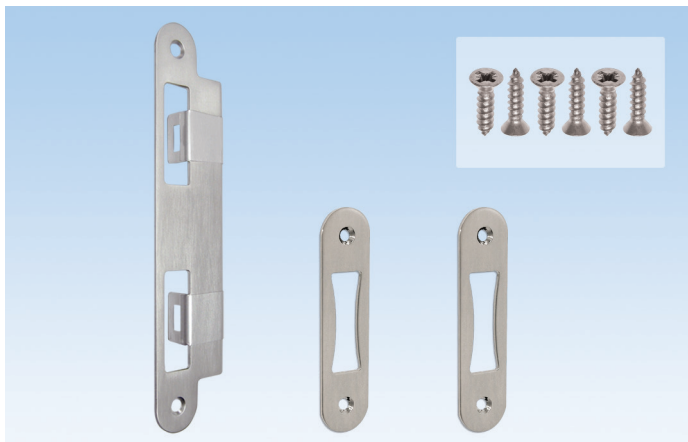

# Strike Plates

for Door Lock



### Top and Bottom Oval Strike Plate

Description	PU	Part Number
Hook bolt strike plate	10	9-C4776-00-0-*
* = Color		PU = Packaging Unit
03 = Polished Brass, 04 = Antique Brass, 5 = Dark Bronze PC, 6 = Black PC, 11 = Satin Nickel, 25 = Dark Bronze, 28 = Pewter		



### Additional information

- Solid brass or stainless steel
- Non-handed
- Two #8 x 5/8 FH/PH screws included
- For use with GU-SECURY SH2 door locks

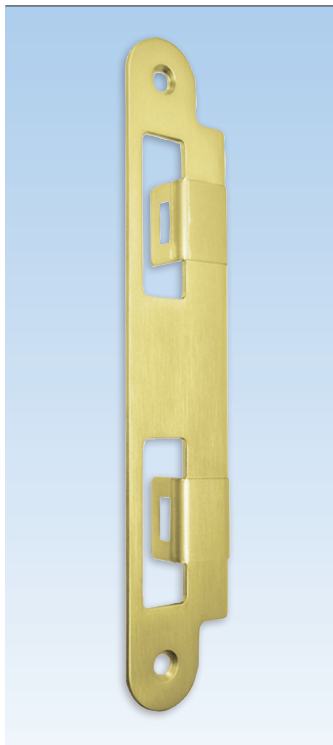

### Middle Strike Plate with Extended Lip

Description	PU	Part Number
Latch and deadbolt strike plate for 45mm (1 3/4") thick doors	10	9-C4777-45-0-*
Latch and deadbolt strike plate for 57mm (2 1/4") thick doors	10	9-C4777-57-0-*
* = Color		PU = Packaging Unit
03 = Polished Brass, 04 = Antique Brass, 5 = Dark Bronze PC, 6 = Black PC, 11 = Satin Nickel, 25 = Dark Bronze, 28 = Pewter		

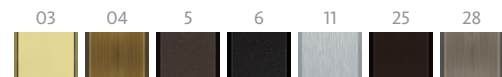

### Additional information

- Solid brass or stainless steel
- Non-handed
- With clear protective film
- Available in handle matching finishes
- Two #8 x 5/8 FH/PH screws included
- For use with GU-SECURY SH2, S-Bolt, Automatic and mortise door locks

# Strike Plates

for Door Lock

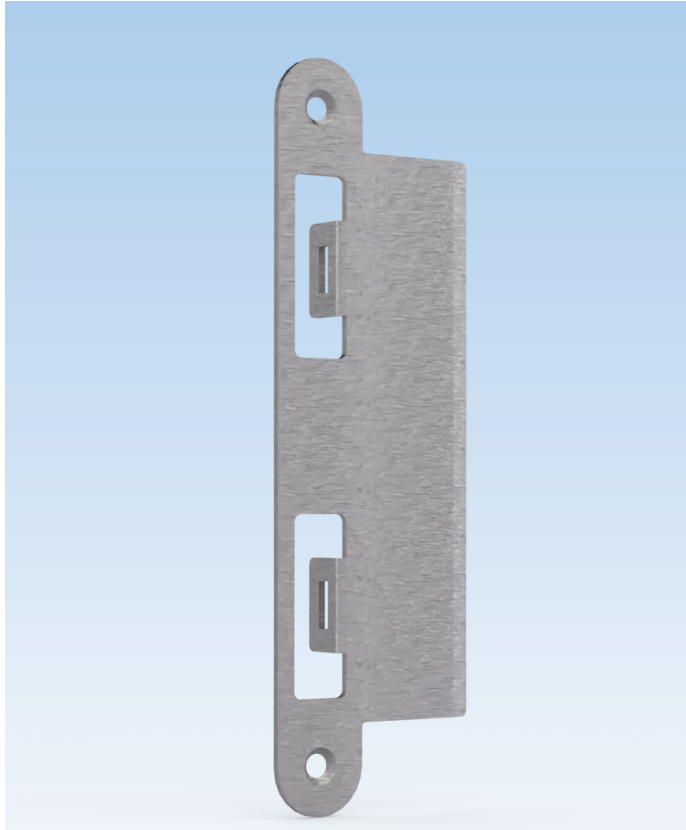

### Middle Striker with Extended Lip

Description	PU	Part Number
Latch and deadbolt strike plate for 76mm (3") thick doors	10	9-C4717-59-0-*
* = Color		PU = Packaging Unit
8B = Stainless Steel, 6 = Black PC		



### Additional information

- Made in stainless steel
- Non-handed
- Two #8 x 5/8 FH/PH screws not included
- For use with GU-SECURY SH2, S-Bolt, Automatic and mortise door locks



### Torx 15 T-Key

Description	Color	PU	Part Number
Torx key	Steel	1	H-00346-15-0-0
PU = Packaging Unit			

#### Additional information

- Used for connecting SH2 and Automatic extensions



### 4mm Allen T-Key

Description	Color	PU	Part Number
Allen key	Steel	1	H-00345-04-0-0
PU = Packaging Unit			

#### Additional information

- Used for reversing Automatic latchbolts on GU-SECURY Automatic lock and extension



### Fastening Screws

Description	Color	PU	Part Number
D1 screws	Stainless Steel	1000	9-C5362-32-0-8
PU = Packaging Unit			

#### Additional information

- Stainless steel lock fastening screws
- Type D1 with self-drilling spiral point and high duplex thread with "Quadrex" socket
- Sharp tip for quick drive



### PEEK Cream Cleaner

Description	PU	Part Number
100mL tube	1	
PU = Packaging Unit		

#### Additional information

- Cleans, polishes and protects the surface
- Successfully used to clean SS surfaces on handles and pullbars
- Leaves behind a light and invisible protective coating
- Available at Amazon , Candian Tire or other hardware store



### Handle Set Color Chips

Description	PU	Part Number
Color chips	1	K-C4780-00-0-0
* = Color		PU = Packaging Unit
01 = Satin Chrome, 03 = Polished Brass, 04 = Antique Brass, 05 = Oil Rubbed Bronze, 5 = Dark Bronze PC, 6 = Black PC, 7 = White PC, 11 = Satin Nickel, 25 = Dark Bronze, 28 = Pewter		

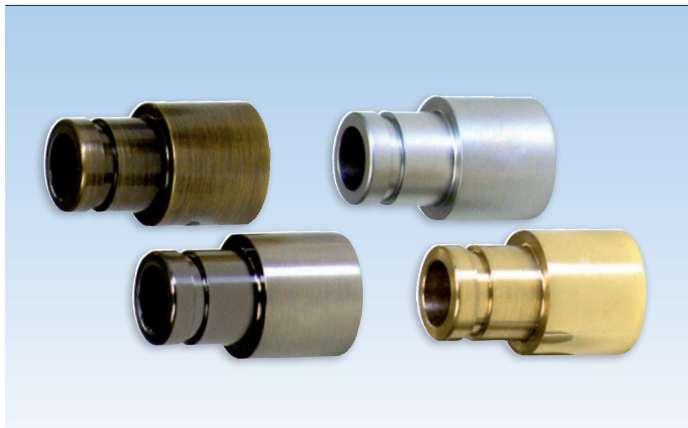

### Handle Extenders

Description	PU	Part Number
Handle extenders	1	9-C0695-00-0-*
* = Color		PU = Packaging Unit
01 = Satin Chrome, 03 = Polished Brass, 04 = Antique Brass, 05 = Oil Rubbed Bronze, 5 = Dark Bronze, 6 = Black, 25 = Dark Bronze, 28 = Pewter		

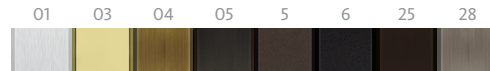

### Additional information

- Made of solid brass
- Use with our solid brass handle sets
- Extends 18mm

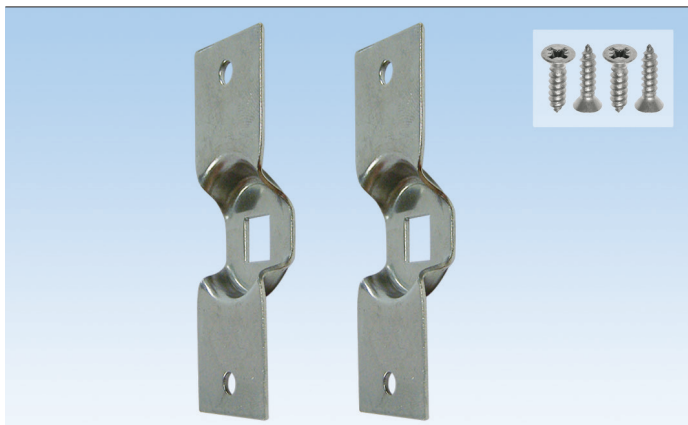

### Fixing Plate for Dummy Trim Kits

Description	PU	Part Number
Fixing plate used for fixed door handle	50	9-U8210-00-0-3
PU = Packaging Unit		

### Additional information

- Made of Zinc plated steel
- Bag of two dummy plates and four #6 x 5/8" FH/PH screws
- Included with Handle Dummy kits
- Part not required for Active & Semi-Active handles
- Fixing in the door

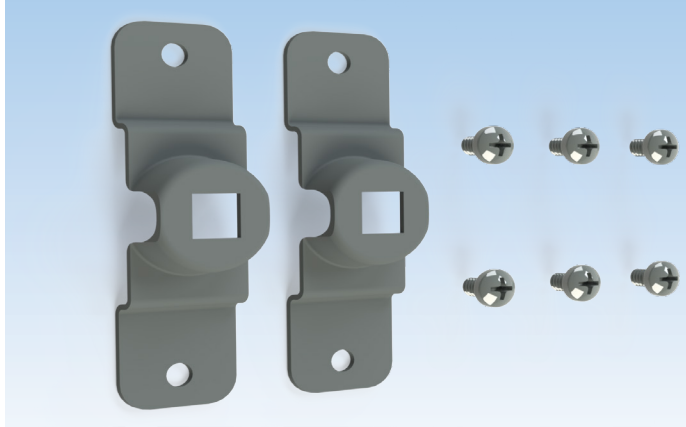

### Fixing Plate for Dummy Trim Kits with 55 and 65mm plate

Description	PU	Part Number
Fixing Plate for Dummy trim kits	1	K-C0973-00-0-0
PU = Packaging Unit		

#### Additional information

- Made of Zinc plated steel
- Bag of two dummy plates and six M4x5mm PH screws
- Included with 55 and 65mm plate Handle Dummy Kits
- Part not required for active and semi-active handles
- Mounting in the plate

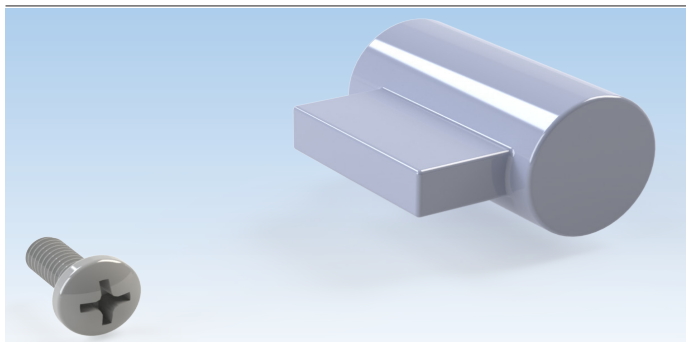

### Dummy conversion kit

Description	PU	Part Number
Dummy conversion kit	1	K-C0971-00-0-*
* = Color		PU = Packaging Unit

11 = Satin Nickel, 25 = Dark Bronze

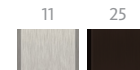

#### Additional information

- Made of Brass
- Bag of one dummy cylinder and one M4 x 10mm PH screw
- Pre-installed with dummy and semi-active handles with 65mm plate
- Part not required for active handles

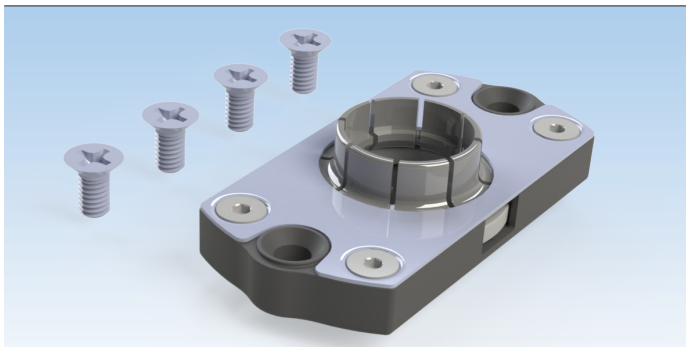

### Replacement Snap & Turn box

Description	PU	Part Number
Boitier Snap & Turn	1	K-C2057-00-0-0
PU = Packaging Unit		

#### Additional information

- Bag of one box and four M4 x 8mm FH/PH screws
- Included with handle sets with 65mm plate

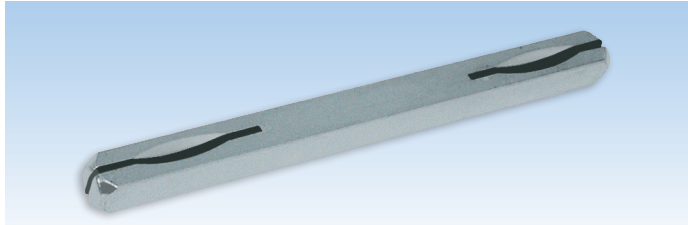

### 8mm Spindle

Description		PU	Part Number
8 x 8 x 120mm spindle for 41-57mm thick doors <i>(1 spindle is supplied with door handle kit)</i>	Zinc	10	9-U8100-20-0-8
8 x 8 x 130mm spindle for 57-76mm thick doors	Zinc	10	9-U8100-30-0-8
PU = Packaging Unit			

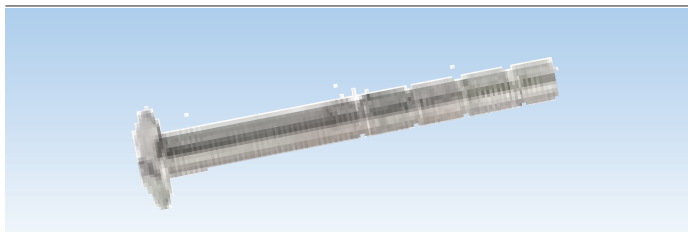

① For 41-76 mm thick doors

### Re-cuttable M5 Screw

Description	PU	Part Number
① M5 x 90mm screws <i>(2 screws are supplied with door handle kit)</i>	1	9-U2510-90-R-*
M5 x 110mm screws (doors 36-101.6 mm)	1	9-U2510-10-R-*
* = Color      PU = Packaging Unit		
01 = Satin Chrome, 03 = Polished Brass, 04 = Antique Brass, 05 = Oil Rubbed Bronze, 5 = Dark Bronze, 6 = Black, 7 = White, 11 = Satin Nickel, 25 = Dark Bronze, 28 = Pewter		



### Set Screw & Allen Key

Description	Color	PU	Part Number
M5 set screw <i>(2 screws are included with door handle kit)</i>	Stainless Steel	1	9-U6008-05-0-1
Allen key 2.5 x 20 x 100mm <i>(1 Allen key is supplied with door handle kit)</i>	Black	1	9-U0003-00-0-00
PU = Packaging Unit			

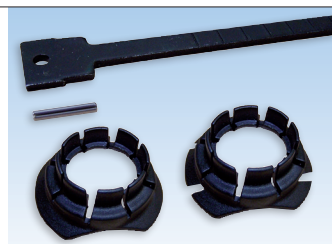
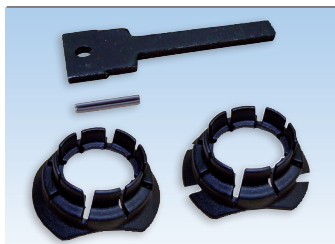

### Knob Tail Replacement Kits

Description	Color	PU	Part Number
48mm knob tail with snap rings	Black	1	K-C0600-48-0-0
72mm recutable knob tail with snap rings	Black	1	K-C0600-72-0-0
PU = Packaging Unit			

### Additional information

- Knob tail made of tempered steel
- Used for semi-active handle trim kits
- 48 mm for doors from 1 3/4" to 2 3/4"
- 72mm recutable for doors from 2 3/4" to 3 5/8"



### Snap Rings

Description	Color	PU	Part Number
Snap ring (For handles purchased before 2021)	Black	1	9-C0645-02-0-6
Snap ring – low profile	Black	1	9-C0645-03-0-6
PU = Packaging Unit			



### Washers

Description	Color	PU	Part Number
Nylatron washer 0.25mm x 16mm (inner dia.)	Clear	1	9-C0647-25-0-0
Nylatron washer 0.5mm x 16mm (inner dia.)	Clear	1	9-C0647-50-0-0
Nylatron washer 1.0mm x 16mm (inner dia.)	Clear	1	9-C0647-10-0-0
PU = Packaging Unit			



### “O” Ring

Description	Color	PU	Part Number
“O” ring 1.5mm x 16mm (inner dia.)	Black	1	9-C0953-00-0-6
PU = Packaging Unit			

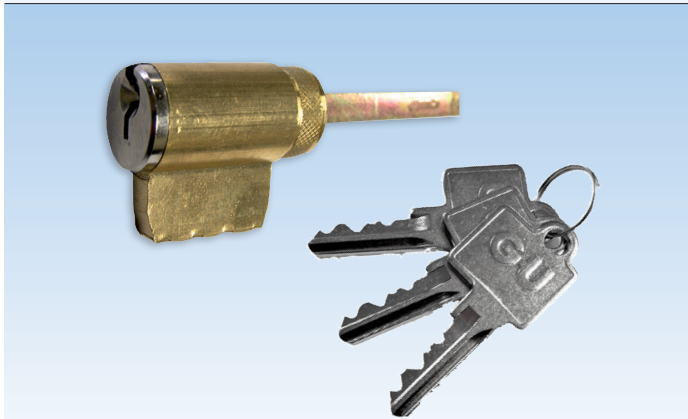

### Cylinders Schlage “C” Keyway

Description	Color	PU	Part Number
① Cylinder with 52mm tail and set of three keys	Zinc	1	6-C0971-52-0-1
	Brass	1	6-C0971-52-0-3
	Dark Bronze	1	6-C0971-52-0-25
② Cylinder with 64mm tail and set of three keys	Zinc	1	6-C0971-64-0-1
	Dark Bronze	1	6-C0971-64-0-25
③ Cylinder with 90 mm tail and set of three keys	Zinc	1	6-C0971-90-0-1
	Brass	1	6-C0971-90-0-3
	Dark Bronze	1	6-C0971-90-0-25
PU = Packaging Unit			

### Key Alike Cylinders Schlage “C” Keyway

Description	Color	PU	Part Number
① Cylinder with 52mm tail and set of three keys	Zinc	1	6-C0971-52-9-1
	Brass	1	6-C0971-52-9-3
	Dark Bronze	1	6-C0971-52-9-25
② Cylinder with 64mm tail and set of three keys	Zinc	1	6-C0971-64-9-1
	Dark Bronze	1	6-C0971-64-9-25
③ Cylinder with 90mm tail and set of three keys	Zinc	1	6-C0971-90-9-1
	Brass	1	6-C0971-90-9-3
	Dark Bronze	1	6-C0971-90-9-25
PU = Packaging Unit			

- ① For 41-57 mm thick doors with plate 30,45,55mm
- ② For 41-57 mm thick doors with plate 65mm
- ③ For 41-76 mm thick doors

Master Key : 9-C9990-CM-0-0  
Key blank : 9-C0974-02-0-0

# Accessories

for Lever Handle

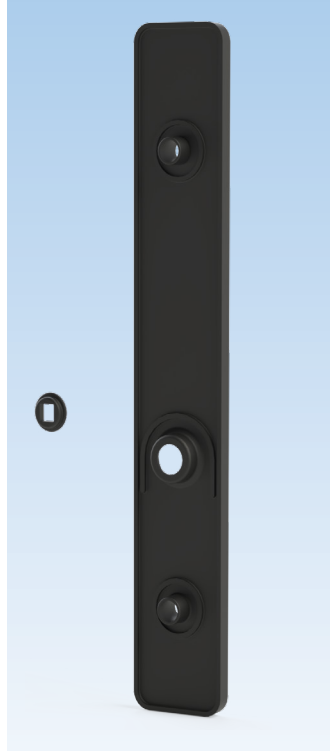

### Gasket 55mm

Description	Color	PU	Part Number
Gasket for active plate	Black	1	6-C0825-55-0-6
Gasket for inactive plate	Black	1	6-C0826-55-0-6
PU = Packaging Unit			

### Additional information

- Not compatible with Dummy Handle fixing Plates K-C0973-00-0-0. To use this product in a dummy handle configuration, use fixing plates 6-C0800-03-0-0

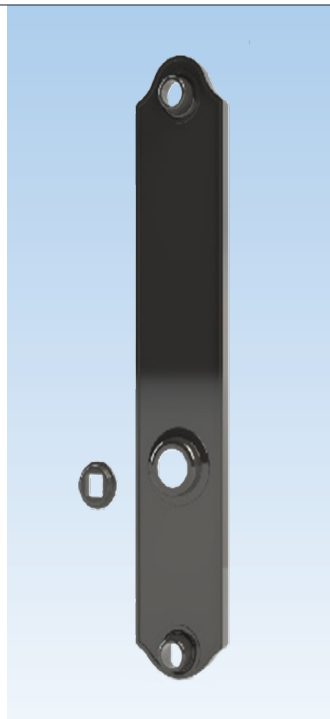
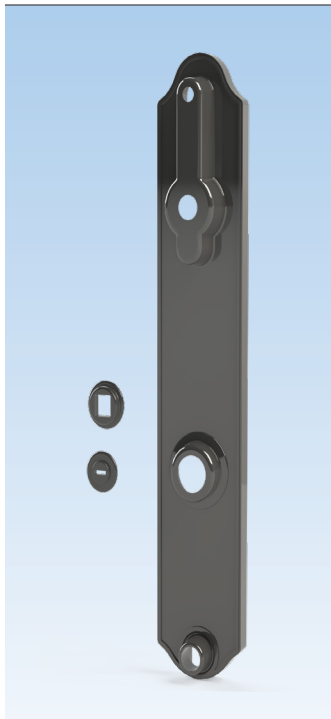

### Gasket 45mm

Description	Color	PU	Part Number
Gasket for active plate	Black	1	6-C0825-00-0-6
Gasket for inactive plate	Black	1	6-C0826-00-0-6
PU = Packaging Unit			



### Dust Cup with Edge – 25mm

Description	Color	PU	Part Number
Plastic cup	Black	10	9-C4765-00-0-6
		100	9-C4765-1C-0-6
		500	9-C4765-5C-0-6
PU = Packaging Unit			

### Additional information

- Use for latch and 2 automatic latches (optional)
- Dimensions:
  - Length: 62mm
  - Width: 19.5mm
  - Depth: 25.8mm



### Dust Cup without Edge – 15mm

Description	Color	PU	Part Number
Plastic cup	Black	10	9-C4765-0A-0-6
		100	9-C4765-1C-A-6
		500	9-C4765-5C-A-6
PU = Packaging Unit			

### Additional information

- Dimensions:
  - Length: 62mm
  - Width: 19.5mm
  - Depth: 16mm



### Screws for Strike Plates

Description	PU	Part Number
#8 x 5/8" (16mm) screws	10	K-C4763-16-6-*
* = Color		PU = Packaging Unit

03 = Polished Brass, 04 = Antique Brass, 5 = Dark Bronze PC, 6 = Black PC, 11 = Satin Nickel, 25 = Dark Bronze, 28 = Pewter

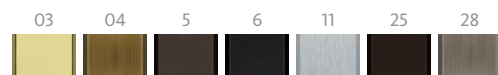

### Additional information

- Bag of 6 screws for strike plates
- #8 x 5/8" FH/PH screws



**Construction Handle Set**

Description	Color	PU	Part Number
Construction handle	Black	25	K-C9250-25-0-6
PU = Packaging Unit			

**Additional information**

- Reinforced nylon temporary door trim sets
- 8 x 8 x 90mm square spindle included
- 4.2 x 50mm screws included
- For 1 3/4" thick doors
- Locking/Unlocking from inside only



**Construction Key**

Description	Color	PU	Part Number
Construction key	Black	10	9-U0001-01-0-0
PU = Packaging Unit			

**Additional information**

The construction key is available for those who prefer to install the decorative hardware trim and lever sets on doors after the construction has been completed. Installing the escutcheon plates and levers in the final stage of construction prevents the decorative trim from becoming scratched or damaged.

The construction key has been designed to accommodate multipoint door hardware (8mm square), tilt-turn hardware (7mm square) and lift-slide hardware (10mm square).

# Wood Mount Display

for Lever Handle



## Wood Mount Display with Lever Handles

Description	PU	Part Number
Wood mount display	1	6-C9618-00-0-*
* = Color		PU = Packaging Unit
01 = Satin Chrome, 03 = Polished Brass, 04 = Antique Brass, 05 = Oil Rubbed Bronze, 5 = Dark Bronze PC, 6 = Black PC, 11 = Satin Nickel, 25 = Dark Bronze, 28 = Pewter		



### Additional information

- To be used with 30 and 45mm escutcheons and Capri, Torino, Allegro or Venice handles
- 7" x 7" x 17" 1/4 (17.75 cm x 17.75 cm x 44 cm)



## Handles Display with Lever Handles

Description	PU	Part Number
ROMA 55	1	K-C9608-A0-0-7
CAPRI	1	K-C9608-A2-0-7
TORINO 30	1	K-C9608-A4-0-7
BERLIN 65	1	K-C9608-A5-0-7
VENISE 45	1	K-C9608-A6-0-7
ALLEGRO 30	1	K-C9608-A8-0-7
Display Base	1	6-C9602-00-0-6
PU = Packaging Unit		

\* Models in this table are also available in French.

- Display delivered with wall mounted kit
- The display base is an option to place the unit on a desk, to be ordered separately
- 21"1/2 x 32" x 12" (53.2 cm x 80.25 cm x 30.5 cm)



WINDOW TECHNOLOGY  
DOOR TECHNOLOGY  
AUTOMATIC ENTRANCE SYSTEMS  
BUILDING MANAGEMENT SYSTEMS



HEAD OFFICE

Ferco Architectural Hardware Inc.  
2000, Berlier St.  
Laval, QC H7L 4S4  
Tel.: 450 973-1437  
1 800 355-8810  
Fax: 450 973-7661  
ferco@ferco.ca

ONTARIO / WESTERN PROVINCES

Tel.: 905 282-9588  
1 800 668-5310  
Fax: 905 282-9915

UNITED STATES

Tel.: 1 800 927-1097  
Fax: 1 888 454-0161

[www.ferco.ca](http://www.ferco.ca)

Securing technology for you

