



WINDOW TECHNOLOGY  
DOOR TECHNOLOGY  
AUTOMATIC ENTRANCE SYSTEMS  
BUILDING MANAGEMENT SYSTEMS



DOOR TECHNOLOGY – ORDER CATALOG | SECTION 03.12



## SECURY Automatic European Profile Cylinder Locks

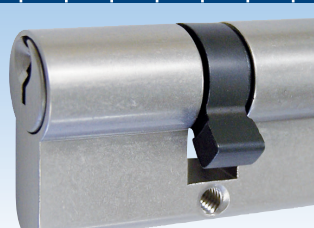
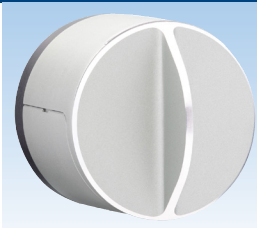

Securing technology for you







# 03.12

## SECURY Automatic – European Profile Cylinder Door Locks

SECURY Automatic European Profile Cylinder Door Locks..	03.12.3
Filler pieces .....	03.12.5
EURO Mortise Door Lock.....	03.12.6
Push-Pull Handles .....	03.12.7
BELCANTO Handle and PZ Rosettes .....	03.12.10
PZ Cylinder .....	03.12.12
Smart locks .....	03.12.13
Strike Plates .....	03.12.17
Accessories .....	03.12.19



# SECURY Automatic – European Profile Cylinder Locks

with European profile cylinder



Unlocked



Locked

## SECURY Automatic European Profile Cylinder Door Lock

Description	Backset	Color	PU	Part Number
Door lock for 6' 8" doors	35mm	SS	5	6-40526-01-R-8B
Door lock for 8' doors	35mm	SS	5	6-40526-02-R-8B
Door lock for 6' 8" doors	45mm	SS	5	6-40526-03-R-8B
Door lock for 8' doors	45mm	SS	5	6-40526-04-R-8B
Door lock for 6' 8" doors	55mm	SS	5	6-40526-05-R-8B
Door lock for 8' doors	55mm	SS	5	6-40526-06-R-8B
Door lock for 6' 8" doors	65mm	SS	5	6-40526-07-R-8B
Door lock for 8' doors	65mm	SS	5	6-40526-08-R-8B

PU = Packaging Unit

### Simply Close the Door!

As soon as the door is pulled shut, the Automatic latchbolts instantly throw 20mm and are secured to prevent them from being forced back. By turning the key or the knob, the center deadbolt will engage and lock the top and bottom latchbolts to become a **3-deadbolt locking system**.

### Additional information

- 3-point, one piece locking system for 6' 8" and 8' doors
- Heavy duty mortise construction with reinforced lever return spring system
- Locking by PZ cylinder with 180° turn of key or thumb-turn
- Unlocking with 180° turn to retract the deadbolt and another 180° turn to retract the latches
- No lifting of handle to engage locking points
- Top and bottom Automatic latchbolt projection from 10 to 20mm:
  - Provides security
  - Protects the door
- 3/4" (20mm) throw on deadbolt
- Non handed, latch easily reversible
- 8mm square spindle
- 92mm centres (spindle to cylinder)
- 16mm stainless steel faceplate with radius ends for easy installation and cleaner look
- Same hardware groove detail throughout our entire door lock program (jig, router base and bits available)
- Extensions with additional lock point are available for doors taller than 8'
- 360° turn with profile cylinders

# Automatic Extension

with Additional Latchbolt - Rounded End

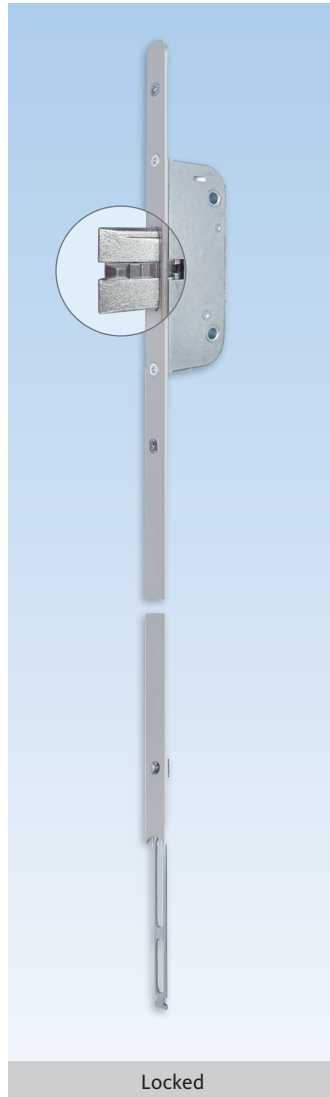
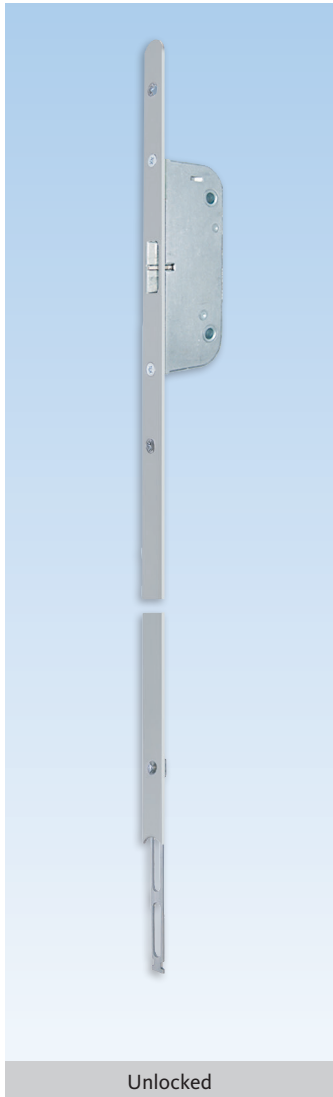

### Extension with Additional Latchbolt

Description	Color	PU	Part Number
525mm extension with rounded end	Stainless Steel	5	6-33479-04-0-8B
800mm extension with rounded end	Stainless Steel	1	6-C5078-00-0-8B
1050mm extension with rounded end	Stainless Steel	1	6-C5062-10-0-8B
1325mm extension with rounded end	Stainless Steel	1	6-C5062-13-0-8B
* = Color		PU = Packaging Unit	

### Additional information

- Tapered latch always engaging in strike plate
- 16mm stainless steel faceplate with radius end for easy installation and cleaner look
- Additional locking point for doors taller than 8'
- To be used with GU-SECURY Automatic door Locks

# Filler pieces

Round to square

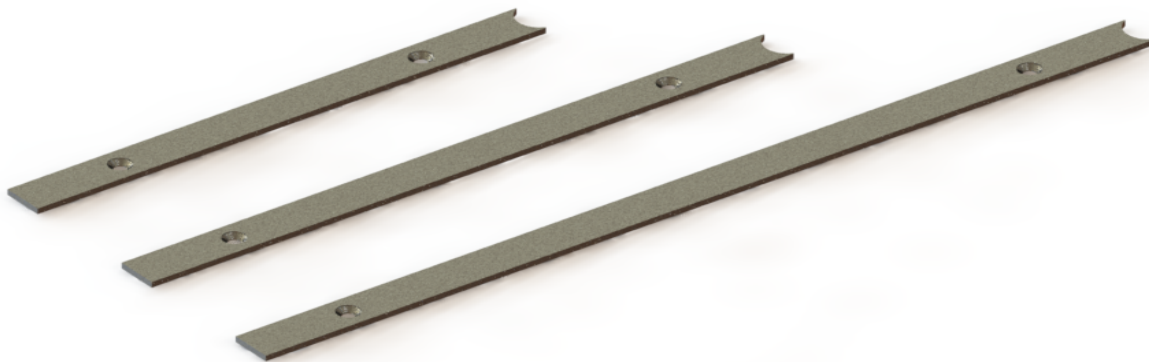

## Filler Pieces Round to square

Description	PU	Part Number
Filler piece 193,7mm x 16 mm	1	9-C4340-19-0-8B
Filler piece 245,9 mm x 16 mm	1	9-C4342-24-0-8B
Filler piece 342,3 mm x 16 mm	1	9-C4342-34-0-8B

### Additional information

- Made of stainless steel
- To be used with radius end locks and extensions

### Formulas to select filler length:

- Bottom:  
L = Handle height - 720,7mm
- Top 1590mm lock:  
L = Door height - handle height - extension(s) length - 871,7mm
- Top 1900mm lock:  
L = Door height - handle height - extension(s) length - 1181,7mm

# EURO Mortise Door Lock

## with Latch and Deadbolt



### EURO Mortise Door Lock

Description	Color	PU	Part Number
Door lock with 35mm backset	Stainless Steel	10	6-C4881-35-R-8B
Door lock with 45mm backset	Stainless Steel	10	6-C4881-45-R-8B
Door lock with 55mm backset	Stainless Steel	10	6-C4881-55-R-8B
Door lock with 65mm backset	Stainless Steel	10	6-C4881-65-R-8B
* = Color		PU = Packaging Unit	

### Additional information

- Heavy duty mortise construction with reinforced lever return spring system
- Locking by PZ cylinder with 180° turn of key or thumb-turn
- Unlocking with 180° turn to retract the deadbolt and another 180° turn to retract the latches
- 3/4" (20mm) throw on deadbolt
- Non handed, latch easily reversible
- 8mm square spindle
- 92mm centres (spindle to cylinder)
- 16mm stainless steel faceplate with radius ends for easy installation and cleaner look
- Same hardware groove detail throughout our entire door lock program (jig, router base and bits available)
- Ideal for exterior and interior door applications
- To be used with lever handle set ( PZ cylinder below handle)



# Push-Pull Handle

Contemporary Round

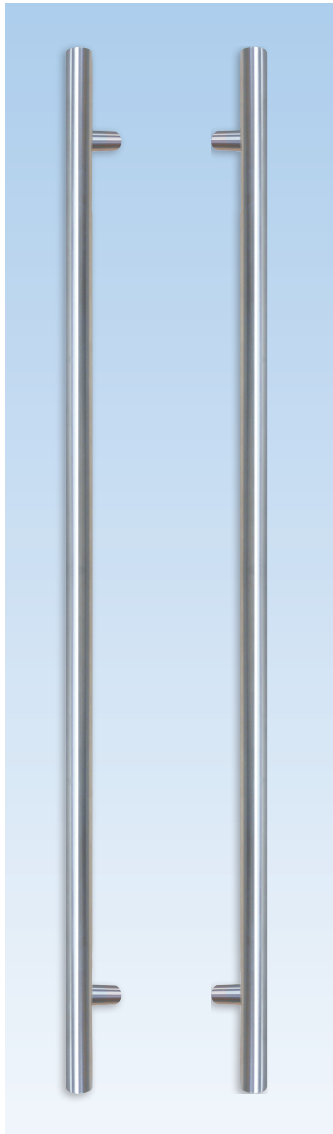

### Rounded Straight Handle

Description	PU	Part Number
Double pull bars Length (A) = 800mm Fixing centers (B) = 600mm	1	K-C0340-08-P-*
Double pull bars Length (A) = 1200mm Fixing centers (B) = 1000mm	1	K-C0340-12-P-*
Double pull bars Length (A) = 1800mm Fixing centers (B) = 1400mm	1	K-C0340-18-P-*
Single pull bars Length (A) = 800mm Fixing centers (B) = 600mm	1	6-C0140-08-0-*
Single pull bars Length (A) = 1200mm Fixing centers (B) = 1000mm	1	6-C0140-12-0-*
Single pull bars Length (A) = 1800mm Fixing centers (B) = 1400mm	1	6-C0140-18-0-*

8B = Stainless Steel, 6 = Black      PU = Packaging Unit



### Additional information

- Made of stainless steel
- Fastening kit included with M8 screws for 1 3/4" and 2 1/4" doors
- Diameter :
  - 35mm for 1800mm pull bars
  - 32mm for 1200mm and 800mm pull bars

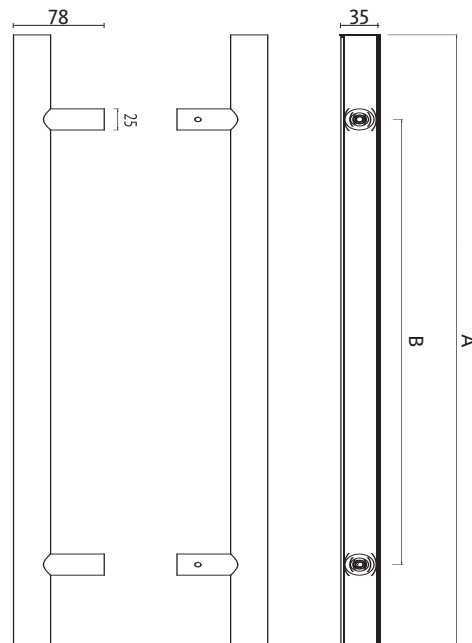

# Push-Pull Angle Handle

Contemporary Round

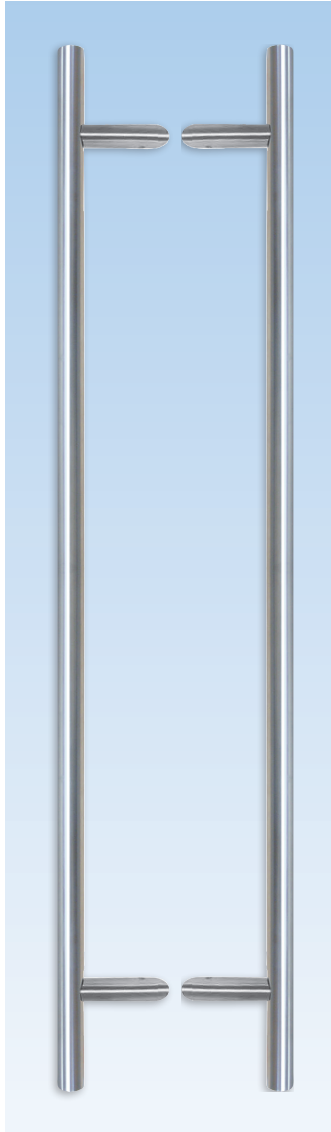

### Rounded 45° Offset Handles

Description	PU	Part Number
Double pull bars Length (A) = 800mm Fixing centers (B) = 600mm	1	K-C0345-08-P-*
Double pull bars Length (A) = 1200mm Fixing centers (B) = 1000mm	1	K-C0345-12-P-*
Double pull bars Length (A) = 1800mm Fixing centers (B) = 1400mm	1	K-C0345-18-P-*
Single pull bars Length (A) = 800mm Fixing centers (B) = 600mm	1	6-C0145-08-0-*
Single pull bars Length (A) = 1200mm Fixing centers (B) = 1000mm	1	6-C0145-12-0-*
Single pull bars Length (A) = 1800mm Fixing centers (B) = 1400mm	1	6-C0145-18-0-*

8B = Stainless Steel, 6 = Black      PU = Packaging Unit



### Additional information

- Made of stainless steel
- Gives more clearance to the door jamb
- Fastening kit included with M8 screws for 1 3/4" and 2 1/4" doors
- Diameter :
  - 35mm for 1800mm pull bars
  - 32mm for 1200mm and 800mm pull bars

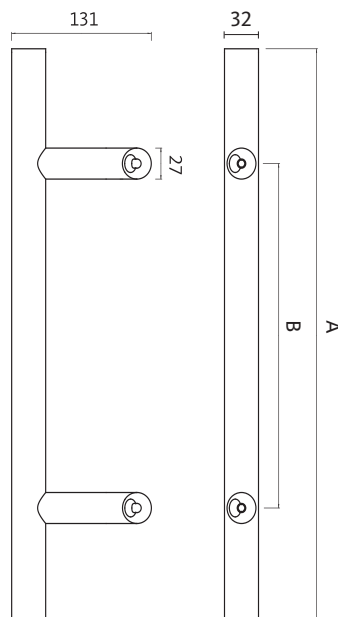

# Push-Pull Handle

Contemporary Rectangular

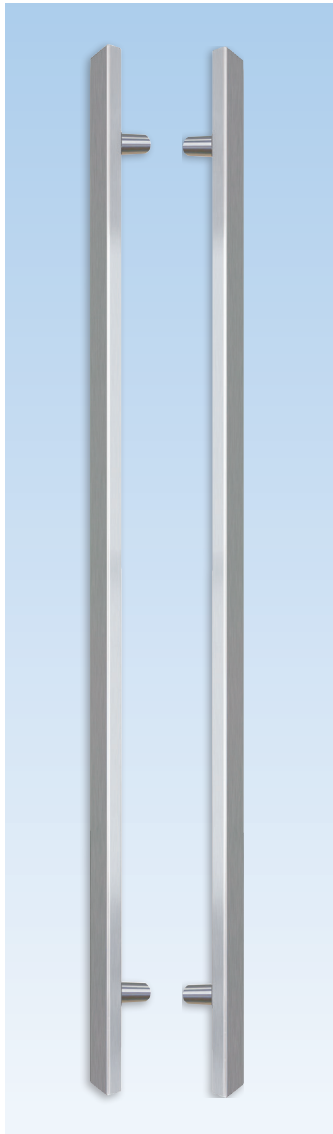

### Rectangular Straight Handle

Description	PU	Part Number
Double pull bars Length (A) = 1200mm Fixing centers (B) = 1000mm	1	K-C0350-12-P-*
Single pull bars Length (A) = 1200mm Fixing centers (B) = 1000mm	1	6-C0150-12-0-*
8B = Stainless Steel, 6 = Black		PU = Packaging Unit



### Additional information

- Made of stainless steel
- Fastening kit included with M8 screws for 1 3/4" and 2 1/4" doors

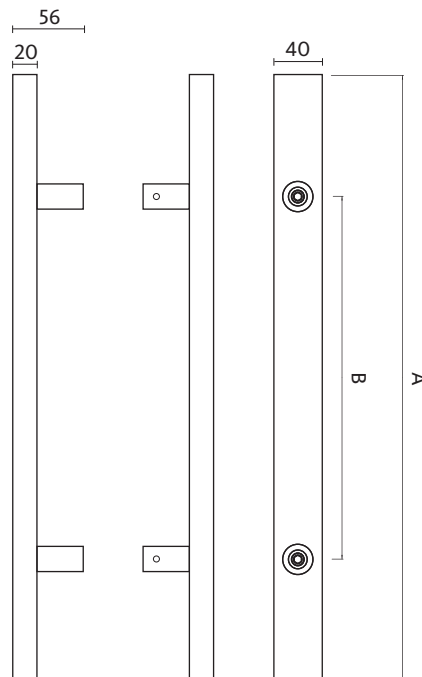

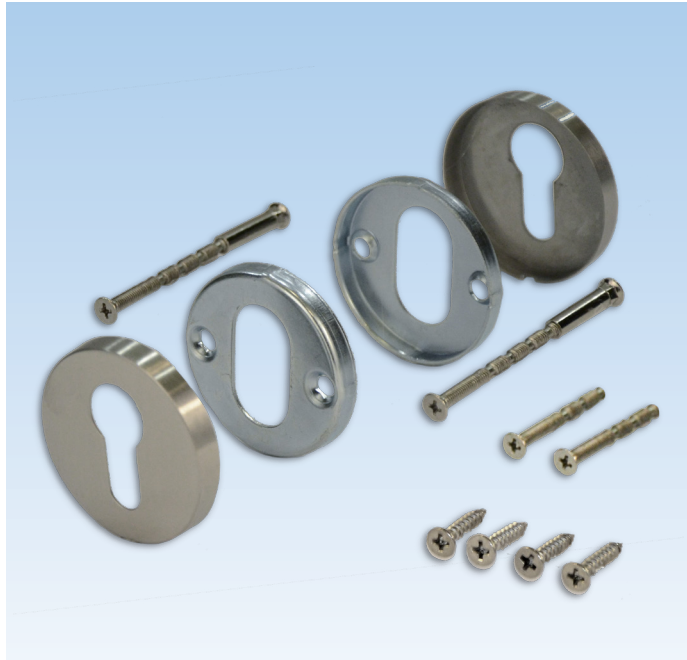

### Round Rosettes

Description	PU	Part Number
Rosettes for profile cylinder	1	K-C9075-00-0-*
* = Color	PU = Packaging Unit	
8B = Stainless Steel, 6 = Black		



### Additional information

- Rosettes made of stainless steel
- Fastening kit included for 1 3/4" and 2 1/4" doors
- Compatible with smart lock (Danalock V3)
- For 1 3/4" doors : use 64mm cylinder (6-U7401-64-0-\*)
- For 2 1/4" doors : use 70mm cylinder (6-U7401-70-0-\*)
- For doors thicker than 2 1/4" up to 3" : cut to length 70mm screws (9-C0570-70-0-1) and 90mm cylinder (6-U7401-90-0-\*)
- External Ø 53 mm x 7.5 mm

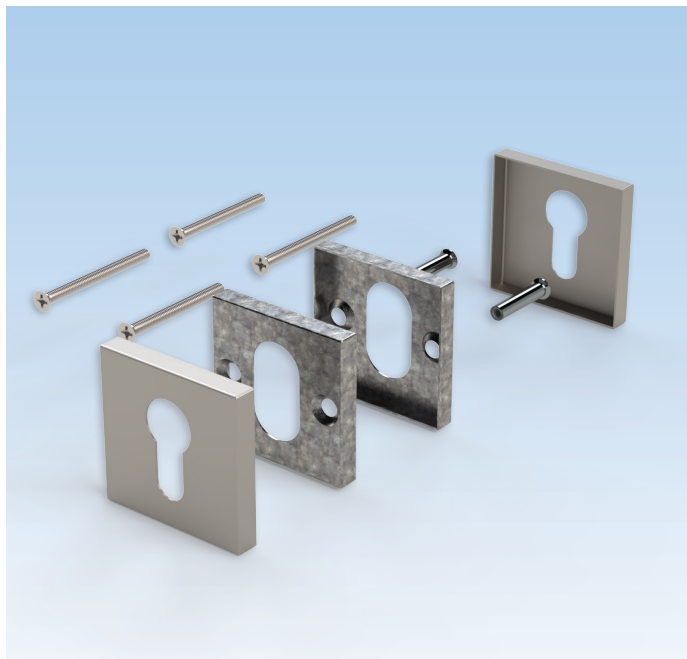

### Square Rosettes

Description	PU	Part Number
Rosettes for profile cylinder	1	K-C9077-00-0-*
* = Color	PU = Packaging Unit	
8B = Stainless Steel, 6 = Black		

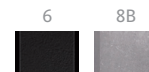

### Additional information

- Rosettes made of stainless steel
- Fastening kit included for 1 3/4" and 2 1/4" doors
- Compatible with smart lock (Danalock V3)
- For 1 3/4" doors : use 64mm cylinder (6-U7401-64-0-\*)
- For 2 1/4" doors : use 70mm cylinder (6-U7401-70-0-\*)
- For doors thicker than 2 1/4" up to 3" : cut to length 70mm screws (9-C0570-70-0-1) and 90mm cylinder (6-U7401-90-0-\*)
- External 53 mm x 7.5 mm

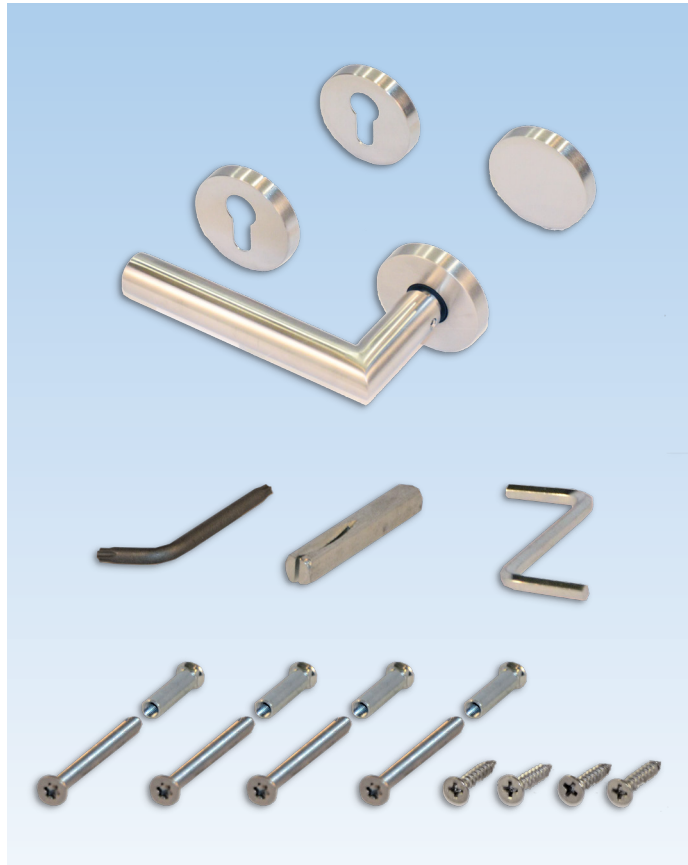

### BELCANTO Half Handle Set and Rosettes

Description	PU	Part Number
Kit of inside handle with rosette and PZ rosette with outside blind rosette and PZ rosette	1	K-C9072-00-0-*
8 = Stainless Steel, 6 = Black		PU = Packaging Unit



#### Additional information

- Fastening kit included for 1 3/4" and 2 1/4" doors
- For 1 3/4" doors : use 70mm cylinder (6-U7401-70-0-\*)
- For 2 1/4" doors : use 80mm cylinder (6-U7401-80-0-\*)



### BELCANTO Handle Set

Description	PU	Part Number
Kit of inside and outside handles	1	K-C9071-00-0-*
* = Color		PU = Packaging Unit
8B = Stainless Steel, 6 = Black		

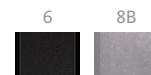

#### Additional information

- Handles and rosettes made of stainless steel
- Fastening kit included for 1 3/4" and 2 1/4" doors
- Fixed lever spring loaded - can't be lifted
- 8mm square spindle
- Concealed fixing screws
- Compatible with smart lock (Danalock V3)
- For doors thicker than 2 1/4" up to 3" : cut to length 70mm screws (9-C0570-70-0-1) and 130mm spindle (9-U8100-30-0-8)

# Euro Profile Cylinder

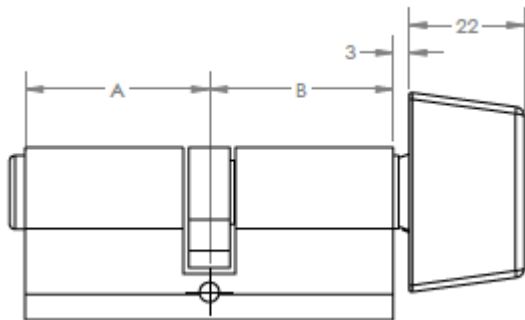
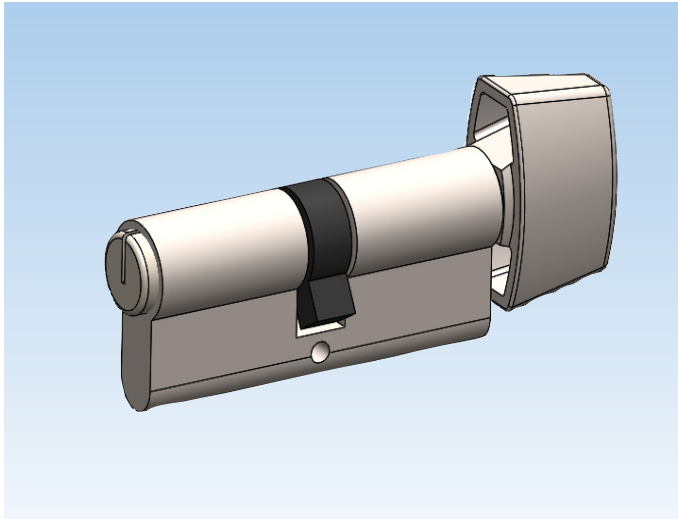

### Profile cylinders

Description	A	B	PU	Part Number
32/32 Cylinder	32	32	1	6-U7401-64-0-*
35/35 Cylinder	35	35	1	6-U7401-70-0-*
40/40 Cylinder	40	40	1	6-U7401-80-0-*
45/45 Cylinder	45	45	1	6-U7401-90-0-11
50/50 Cylinder	50	50	1	6-U7401-00-0-11
10/40 Cylinder Thumbturn	10	40	1	6-U7402-40-0-11
10/45 Cylinder Thumbturn	10	45	1	6-U7402-45-0-11
Rekeying kit for Ferco Schlage keyway			1	K-C4332-00-0-0

11 = Satin Nickel, 6 = Black PU = Packaging Unit

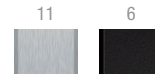

### Additional information

- Refer to rosette to select cylinder length
- For keyed alike profile cylinder add 9-C9995-00-0-0
- 3 keys included
- 70mm screw for backset up to 65mm (Cut to length)
- Schlage Keyway type "C" 5 pins

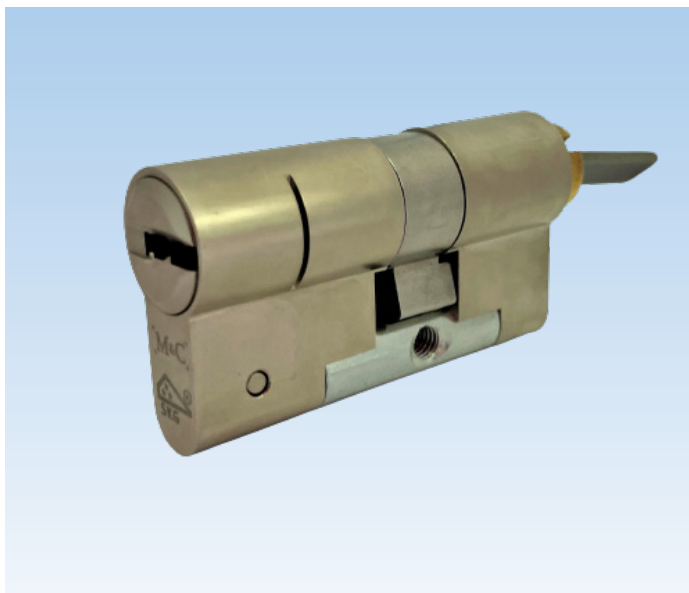

### SALTO Profile cylinders for smart lock

Description	PU	Part Number
Profile cylinder for smart lock - 45mm (1-3/4") thick doors	1	6-U7350-M1-0-01
Profile cylinder for smart lock - 57mm (2-1/4") thick doors	1	6-U7350-M2-0-01
Profile cylinder for smart lock - 70-76mm (2-3/4" to 3") thick doors	1	6-U7350-M3-0-01

01 = Satin Chrome PU = Packaging Unit



### Additional information

- Nickel finish
- 5 keys included
- Compatible with smart lock (Danalock V3)

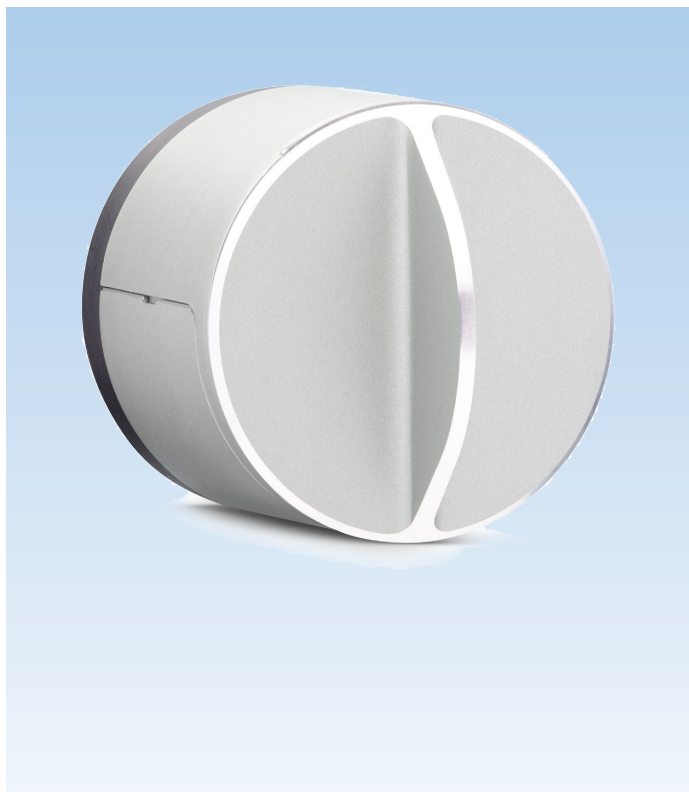

### Smart lock

Description	PU	Part Number
Danalock V3 Z-Wave	1	K-C0380-00-0-1
Danalock V3 Bluetooth	1	K-C0380-01-0-*
* = Color		PU = Packaging Unit
1 = Silver, 6 = Black		



### Additional information

- 4 X CR123A batteries (included)
- Bluetooth 4.2 (Danalock app)
- Z-Wave (Automation hub - only available in Silver finish)
- 256bit AES encryption level
- No cut-out modification required (retro-fit)
- Install with EU rosettes (K-C9075-00-0-\*) and Profile cylinder for smart lock (6-U7350-xx-0-0)
- Fastening screws for 1 3/4" and 2 1/4" doors included with rosettes K-C9075-00-0-\*
- For 3" doors : use M4 x 75mm screws (Not included)



03  
12



### Bluetooth keypad

Description	PU	Part Number
Danapad V3	1	6-C9407-00-0-X
* = Color		PU = Packaging Unit
1 = Silver, 6 = Black		



### Additional information

- 4 X AAA batteries (included)
- Bluetooth 4.2
- 256bit AES encryption level
- Compatible with smart lock (Danalock V3) and Universal Module



### Danalock Remote Access

Description	PU	Part Number
Danabridge V3	1	6-C9402-00-0-0

### Additional information

- 53 mm x 53 mm x 32 mm / Weighs 36 g
- USB power supply
- Add remote access to smart locks (Danalock or Universal Module)
- 2 Smart locks can be controlled with one Danabridge (via Bluetooth 4.2)
- Communication with Wi-Fi 802.11b/g/n



### Danalock Accessories

Description	PU	Part Number
Danalock black inner ring	1	9-C0553-00-0-6



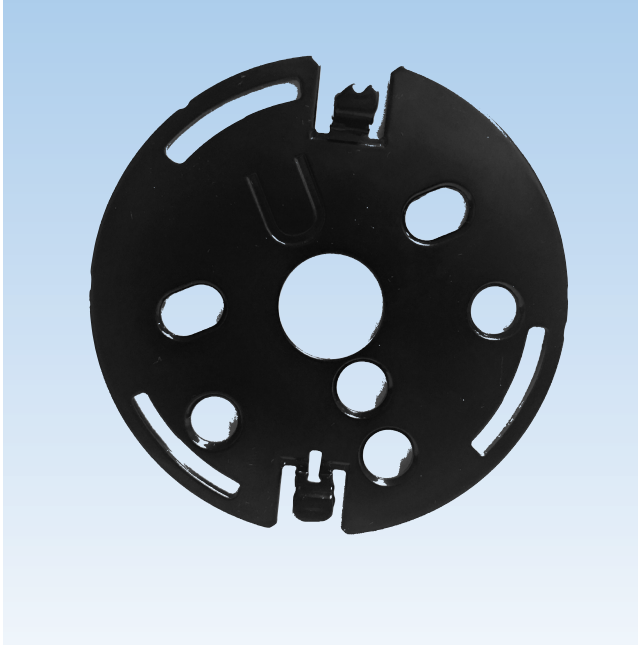

#### Danalock Accessories

Description	PU	Part Number
U Bracket	1	9-C0552-00-0-6

#### Additional information

- Replacement part for K-C0380-00-0-\*



#### Danalock Accessories

Description	PU	Part Number
M4 button hex screws	4	9-C0967-04-0-8

#### Additional information

- Replacement part for K-C0380-00-0-\*



#### Danalock Accessories

Description	PU	Part Number
Green Insert	1	9-C0558-00-0-0

#### Additional information

- Replacement part for K-C0380-00-0-\*

# Smart locks

for Door Lock

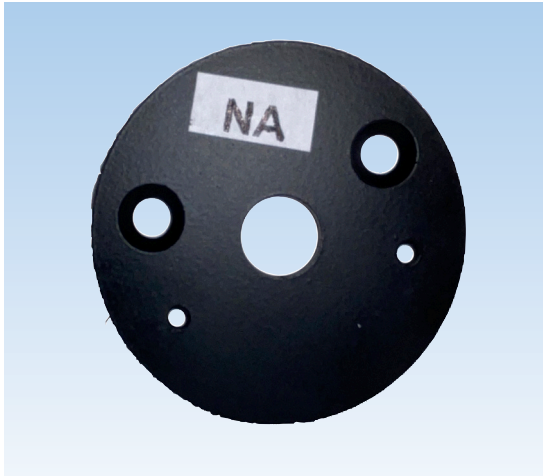

### Danalock Accessories

Description	PU	Part Number
Black spacer NA	1	9-C0545-00-0-6

### Additional information

- Replacement part for K-C0380-XX-0-\*



### Danalock Accessories

Description	PU	Part Number
Black spacer EU 6mm (PZ)	1	9-C0551-06-0-6

### Additional information

- Replacement part for K-C0380-00-0-1



### Danalock Accessories

Description	PU	Part Number
Black spacer EU (PZ)	1	9-C0551-00-0-6

### Additional information

- Replacement part for K-C0380-00-0-1

# Strike Plates

## Bag of Strike Plates

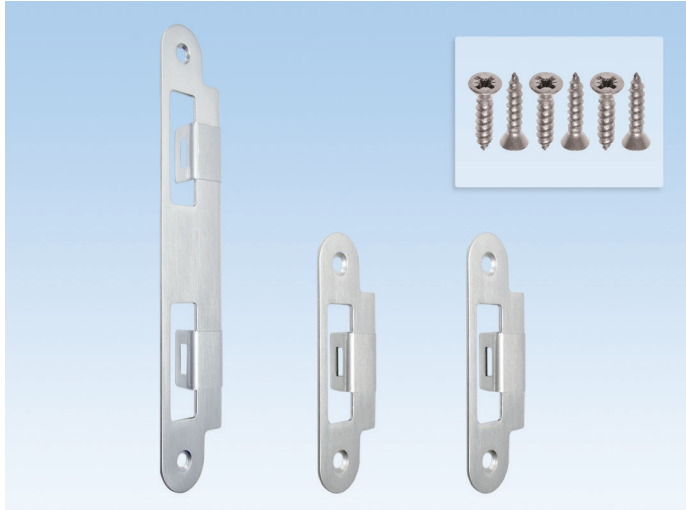

### Bag of Strike Plates

Description	Color	PU	Part Number
Bag of strike plates for 45mm (1 3/4") thick doors	Satin Nickel	50	K-C4774-45-0-*
Bag of strike plates for 57mm (2 1/4") thick doors	Satin Nickel	50	K-C4775-57-0-*
* = Color		PU = Packaging Unit	
03 = Polished Brass, 04 = Antique Brass, 5 = Dark Bronze, 6 = Black, 11 = Satin Nickel, 28 = Pewter			

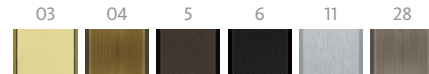

### Additional information

- Solid brass (03, 04, 28 ) or stainless steel (5, 6, 11)
- Bag contains:
  - 1 middle strike plate
  - 2 top and bottom strike plates
  - 6 screws
- Non-handed
- With clear protective film
- Available in handle matching finishes
- For SECURY Automatic door locks

03  
12



### Striker with Extended Lip

Description	PU	Part Number
Latchbolt strike plate for 45mm (1 3/4") thick doors	10	9-C4776-45-0-*
Latchbolt strike plate for 57mm (2 1/4") thick doors	10	9-C4776-57-0-*
* = Color		PU = Packaging Unit
03 = Polished Brass, 04 = Antique Brass, 5 = Dark Bronze, 6 = Black, 11 = Satin Nickel, 28 = Pewter		

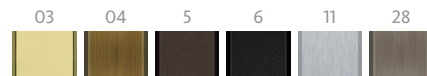

### Additional information

- Solid brass (03, 04, 28 ) or stainless steel (5, 6, 11)
- Non-handed
- With clear protective film
- Two #8 x 5/8 FH/PH screws included
- For use with Automatic extension

# Strike Plates

for Door Lock

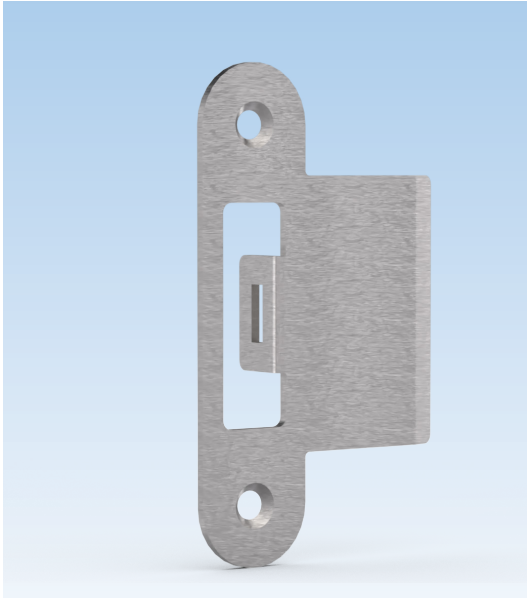

### Top and Bottom Striker with Extended Lip

Description	PU	Part Number
Latchbolt strike plate for 76mm (3") thick doors	10	9-C4716-59-0-*
* = Color		PU = Packaging Unit

8B = Stainless Steel

8B



#### Additional information

- Made in stainless steel
- Non-handed
- Two #8 x 5/8 FH/PH screws included
- For use with GU-SECURY Automatic door lock

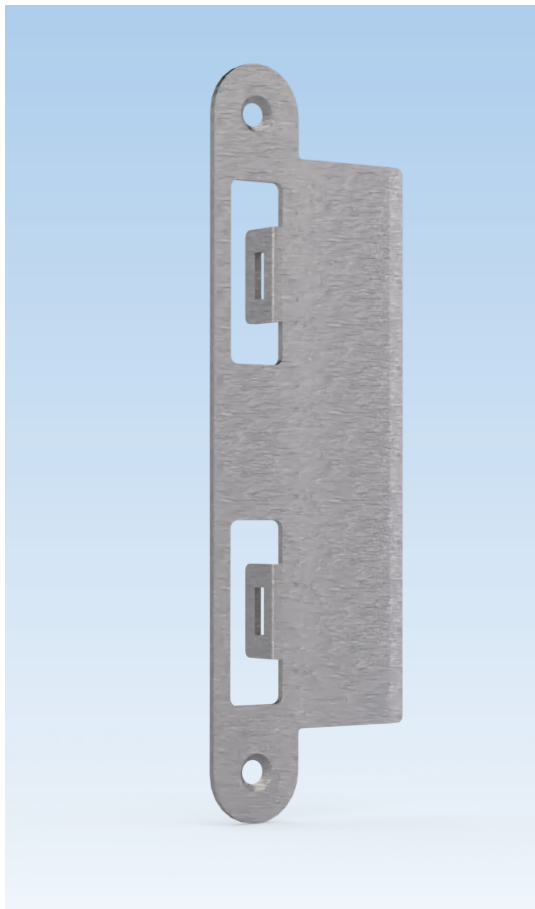

### Middle Striker with Extended Lip

Description	PU	Part Number
Latch and deadbolt strike plate for 76mm (3") thick doors	10	9-C4717-59-0-*
* = Color		PU = Packaging Unit

8B = Stainless Steel

8B



#### Additional information

- Made in stainless steel
- Non-handed
- Two #8 x 5/8 FH/PH screws included
- For use with GU-SECURY Automatic door lock



### Dust Cup with Edge

Description	Color	PU	Part Number
Plastic cup - 25mm	Black	10	9-C4765-00-0-6
Plastic cup - 15mm	Black	10	9-C4765-0A-0-6
* = Color		PU = Packaging Unit	

### Additional information

- Use for latch and 2 automatic latches (optional)
- Dimensions for plastic cup - 25mm:
  - Length: 62mm
  - Width: 19.5mm
  - Depth: 25.8mm
- Dimensions for plastic cup - 15 mm:
  - Length: 62mm
  - Width: 19.5mm
  - Depth: 16mm



### Fastening Screws

Description	Color	PU	Part Number
D1 screws	Stainless Steel	1000	9-C5362-32-0-8
* = Color		PU = Packaging Unit	

### Additional information

- Stainless steel lock fastening screws
- Type D1 with self-drilling spiral point and high duplex thread with "Quadrex" socket
- Sharp tip for quick drive

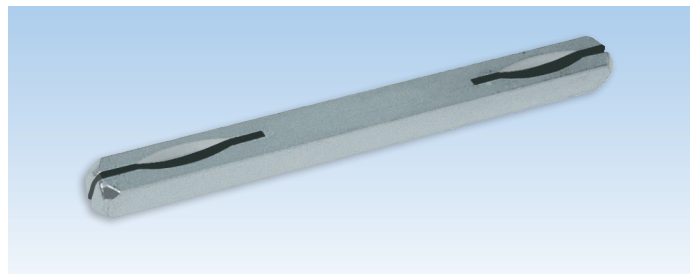

### 8mm Spindle

Description	Color	PU	Part Number
8 x 8 x 120mm spindle for 41-57mm thick doors <i>(1 spindle is supplied with door handle kit)</i>	Zinc	10	9-U8100-20-0-8
8 x 8 x 130mm spindle for 57-76mm thick doors	Zinc	10	9-U8100-30-0-8
* = Color		PU = Packaging Unit	

# Accessories

for Pull Bars

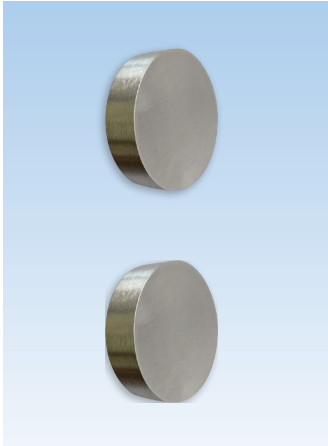

### Replacement Kit of Interior Caps

Description	Color	PU	Part Number
	Stainless steel	1	6-C0531-00-0-*
* = Color		PU = Packaging Unit	
11 = Satin Nickel, 6 = Black			

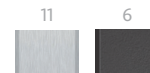

### Additional information

- For single pull bar application (6-C0140, 6-C0145, 6-C0150)
- Made of stainless steel
- Fastening kit included for 1 3/4" and 2 1/4" doors



### Kit of Supporting Plate for Pull Bars

Description	Color	PU	Part Number
Kit of 4 round supporting plates for steel doors	Stainless Steel	1	K-C0960-00-0-8B
* = Color		PU = Packaging Unit	



### PEEK Cream Cleaner

Description	PU	Part Number
100mL tube	1	9-C9030-00-0-0
PU = Packaging Unit		

### Additional information

- Cleans, polishes and protects the surface
- Leaves behind a light and invisible protective coating

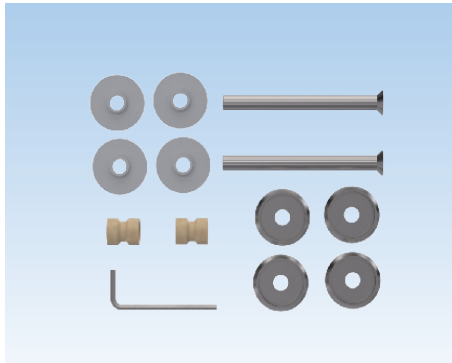

### Replacement parts for Rounded And Rectangular Straight Handle

Description	Color	PU	Part Number
Kit of replacement part	Stainless Steel	1	6-C0535-00-0-8B
* = Color		PU = Packaging Unit	

#### Additional information

- Use with K-C0340-XX-P-\*, K-C0350-12-P-\*, 6-C0140-XX-0-\* and 6-C0150-12-0-\*

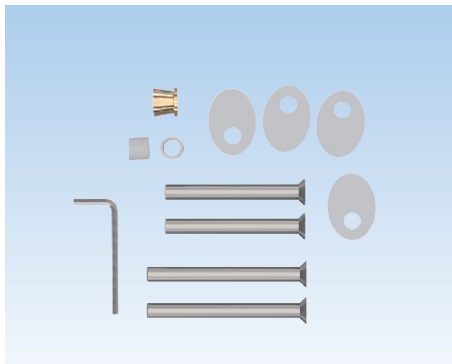

### Replacement parts for Rounded 45° Offset Handles

Description	Color	PU	Part Number
Kit of replacement part	Stainless Steel	1	6-C0536-00-0-8B
* = Color		PU = Packaging Unit	

#### Additional information

- Use with K-C0345-XX-P-\* and 6-C0145-XX-0-\*



#### Torx 15 T-Key

Description	Color	PU	Part Number
Torx key	Steel	1	H-00346-15-0-0
* = Color		PU = Packaging Unit	

#### Additional information

- Used for connecting SH2 and Automatic extensions



#### 4mm Allen T-Key

Description	Color	PU	Part Number
Allen key	Steel	1	H-00345-04-0-0
* = Color		PU = Packaging Unit	

#### Additional information

- Used for reversing Automatic latchbolts on GU-SECURITY Automatic lock and extension



#### Construction Key

Description	Color	PU	Part Number
Key	Black	10	9-U0001-01-0-0
* = Color		PU = Packaging Unit	

#### Additional information

The construction key is available for those who prefer to install the decorative hardware trim and lever sets on doors after the construction has been completed. Installing the escutcheon plates and levers in the final stage of construction prevents the decorative trim from becoming scratched or damaged.

The construction key has been designed to accommodate multipoint door hardware (8mm square), tilt-turn hardware (7mm square) and lift-slide hardware (10mm square).



# Accessories

for Profile Cylinder Door Locks



Construction Key			
Description	Color	PU	Part Number
Key Tool Cylinder Length	Red	1	B 3539 0111
* = Color		PU = Packaging Unit	

### Additional information

The construction key is available for those who prefer to install the decorative hardware trim and lever sets on doors after the construction has been completed. Installing the escutcheon plates and levers in the final stage of construction prevents the decorative trim from becoming scratched or damaged.

Used to operate the multipoint door hardware through the profile cylinder opening, and to measure the profile cylinder length required from the side scale.



A large section of the page consisting of numerous horizontal lines for writing notes, extending from the top of the FERCO logo down to the footer.



WINDOW TECHNOLOGY  
DOOR TECHNOLOGY  
AUTOMATIC ENTRANCE SYSTEMS  
BUILDING MANAGEMENT SYSTEMS

HEAD OFFICE

Ferco Architectural Hardware Inc.  
2000, Berlier St.  
Laval, QC H7L 4S4  
Tel.: 450 973-1437  
1 800 355-8810  
Fax: 450 973-7661  
ferco@ferco.ca

ONTARIO / WESTERN PROVINCES

Tel.: 905 282-9588  
1 800 668-5310  
Fax: 905 282-9915

UNITED STATES

Tel.: 1 800 927-1097  
Fax: 1 888 454-0161

[www.ferco.ca](http://www.ferco.ca)

Edition 05.2022 | Printed in Canada



Securing technology for you

