



CONTENTS

Uni-Jet D	3
Frame Hardware Installation	4
Sash Hardware Prep & Installation	6
Option for Windows Wider Than 750 mm	11
Option for Windows Higher Than 750 mm	12
Handle Installation	15
Sash Placement	16
Keepers Installation	17
Safety Device Installation	19
Covers & Operation	20
Sash Adjustments - Minor Necessary Adjustments	21

Unit-Jet D

ADDITIONAL INFORMATION

APPLICATION

Range of applications for tilt-turn and side hung fittings UNI-JET:

- Single sash windows and patio doors
- Double sash windows and patio doors without mullion
- Single sash patio doors, lockable
- Double sash patio doors without mullion, lockable

UNI-JET D

- Rebate hinge fittings with drill-in or rebate corner hinge and rebate double stay
- For windows and patio doors with 12 mm rebate clearance
- Max. sash weight 100 kg
- Rebate corner hinge, side hung and middle hinge as well as double stay designed for:
 - 9 and 13 mm grooves
 - 18, 20 and 22 mm sash overlap
- Corner bearing 3-way adjustable
- Symmetrical drill pattern for stay arm bearing and corner bearing

TECHNICAL DESCRIPTION

- Fittings with locking mechanisms concealed in the rebate; one handle operation
- All locking points are made for the standard hardware groove of 16.3 mm width and 2.5 mm depth
- Spring-loaded automatic locking pin compensates for rebate clearance deficiencies which sometimes occur - spring travel 1,2 mm; closing pressure of automatic pins adjustable with Torx.
- Clip connection of locking gear and stay arm connecting plate
- Additional ventilation positions possible due to optional slit ventilation springs
- Anti-bang security device in the stay arm

MATERIALS, ANTI-CORROSION PROTECTION

- The fitting components are made of high-quality steel, zinc die cast or aluminium alloys
- Depending on the material, the components are protected against corrosion with the surface sealing FerGUard Silver or by anodisation

Frame Hardware Installation - Symetrical



DRILLING JIG G-20726-XX-4-1



DRILLING FOR BOTTOM HINGE

- Use jig G-20726-XX-4-1 (XX=System profile)
- Use drill bit 6 mm diameter



DRILLING FOR STAY ARM BEARING

- Use jig G-20726-9/13-4-1
- Use drill bit 6 mm diameter



INSTALL BOTTOM HINGE

- Use corner bearing hinge 6-28742-22-0*

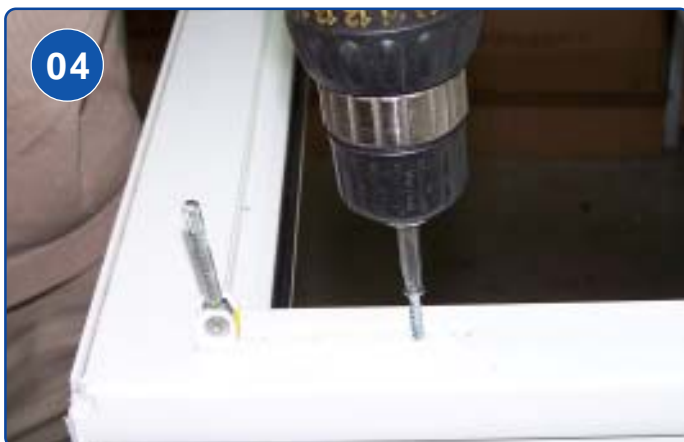

FASTEN INTO PVC

- Use 4 type "D1" screws E-12562-XX-0-1



Frame Hardware Installation - Symetrical



NOTE FLAT SURFACE ON PIN AND STAY ARM BEARING



05
**INSERT PIN INTO STAY ARM BEARING UNTIL FIRST SNAP.
 (FLAT PIN SURFACE WITH FLAT STAY ARM BEARING SURFACE)**

- Use 6-31636-06-0-1



06
**INSTALL STAY ARM BEARING AT TOP OF FRAME WITH PIN
 TOWARD BOTTOM OF WINDOW**

- Use 6-31636-06-0-1



07
FASTEN INTO PVC

- Use 4 type "D1" screws E-12562-XX-0-1

Sash Hardware Prep & Installation - Handle Side

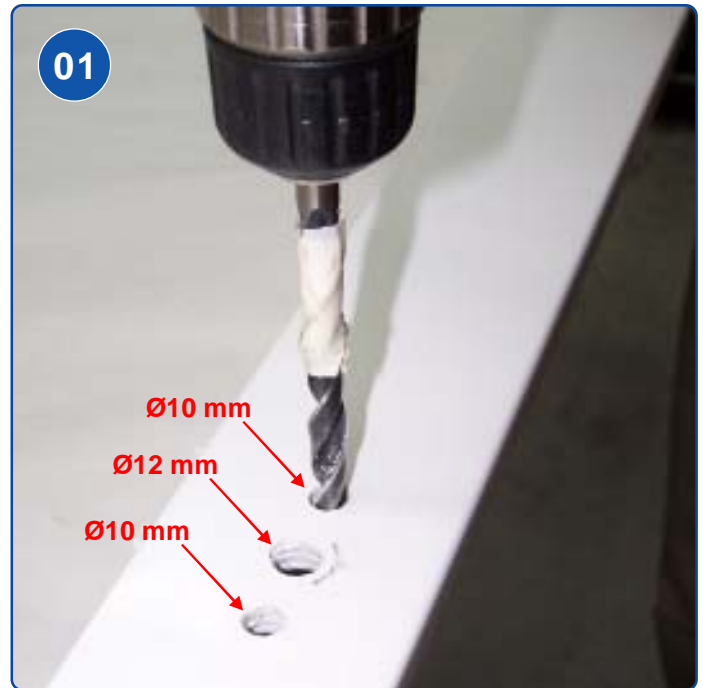
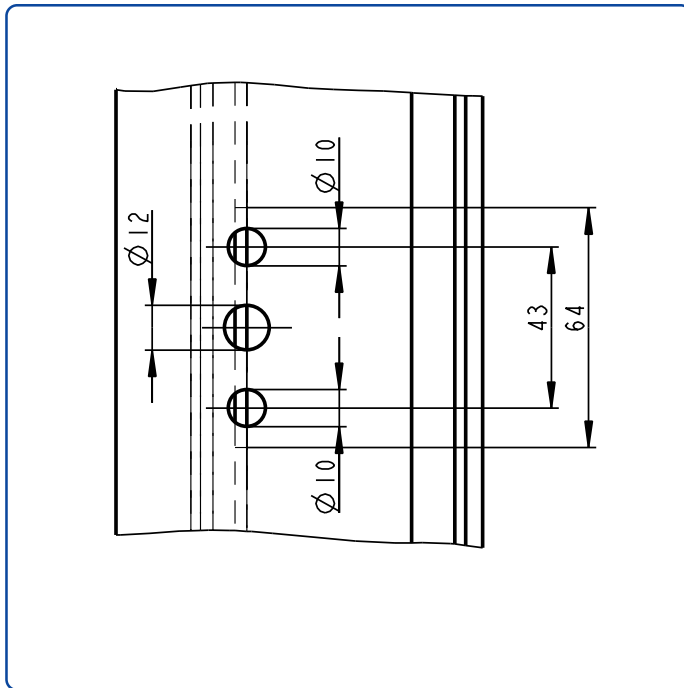

DRILLING FOR LOCK CASE AT CENTER OF SASH

- Spindle hole 12 mm diameter
- Screw port holes 10 mm diameter

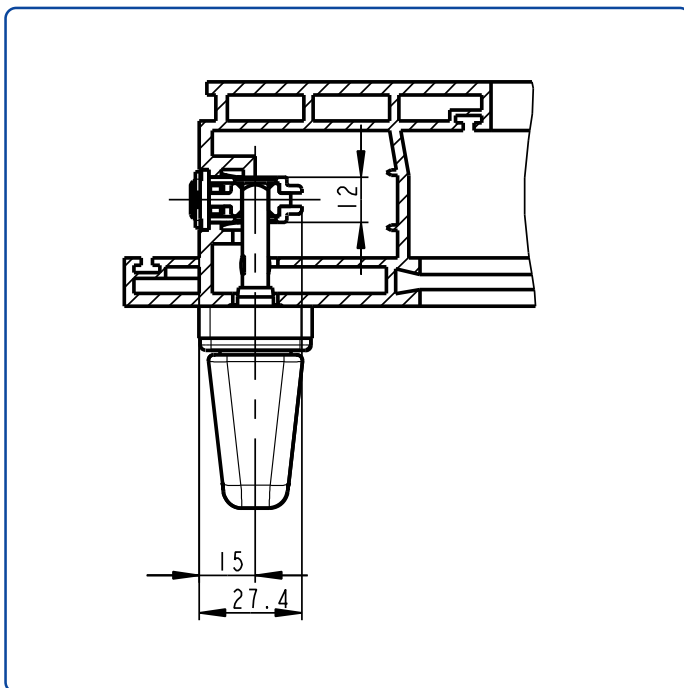

MACHINE LOCK CASE

- Cutout 64 X 15 mm
- Slot at center of sash in eurogroove

Sash Hardware Prep & Installation - Hinge Side



DRILLING JIG 6-27410-09/13-0-0



DRILLING FOR HINGE BEARING AT BOTTOM OF SASH

- Drill 2 holes with 6 mm diameter drill bit



**INSTALL BOTTOM HINGE BEARING
SET WITH FLAT EDGE AT BOTTOM**

- Use 6-28744-00-0-1



**FASTEN WITH TWO 38 mm TYPE "D1"
SCREWS E-12562-XX-0-1**

- Make sure screws are parallel to face of sash

Sash Hardware Prep & Installation - Handle Side



06 INSTALL BOTTOM CORNER TRANSMISSION (ON HANDLE SIDE), LOCKING PINS ON HORIZONTAL EDGE OF SASH

- Corner of eurogroove must be clean
- Use 6-32292-XX-0-1



FASTENNING

- Make sure corner transmission is tight on corner of groove
- Fasten with type (D1) 28-30 mm screws E-12562-XX-0-1



07 INSTALL TOP CORNER TRANSMISSION (ON HANDLE SIDE), LOCKING PIN ON VERTICAL EDGE OF SASH

- Corner of eurogroove must be clean
- Use 6-32021-XX-0-1

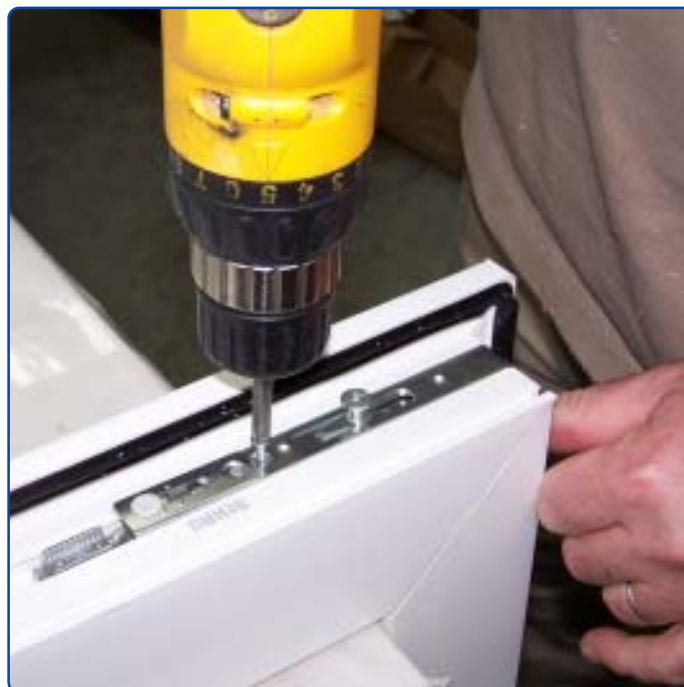

FASTENNING

- Make sure corner transmission is tight on corner of groove
- Fasten with type "D1" 28-30 mm screws E-12562-XX-0-1

Sash Hardware Prep & Installation - Gear Installation



08
MAKE SURE LOCKING CAMS ARE IN CENTRAL POSITION ON ALL COMPONENTS (ALIGNED WITH MARK)



09
PLACE GEAR WITH CAM IN CENTRAL POSITION IN EUROGROOVE AND CAVITY

- Use G-2208X-00-0-1
- Use logo to set side of installation, logo points to top of sash



10
USE HANDLE IN "TURN MODE" TO CENTER GEAR

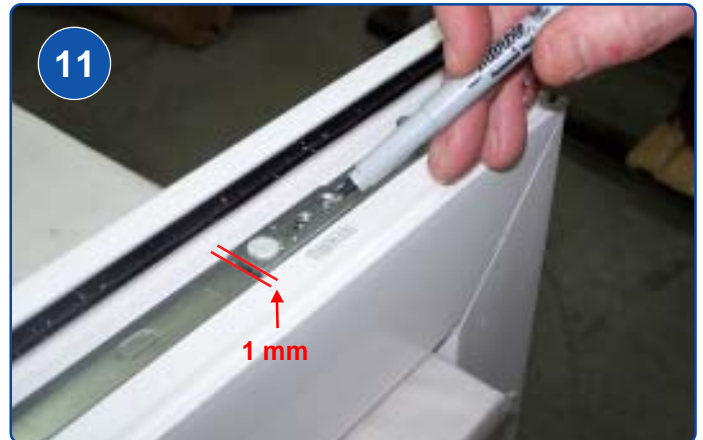

11
MARK CUT OFF POINT 1mm SHORT OF CORNER TRANSMISSION EDGE AT BOTH ENDS

Sash Hardware Prep & Installation



12
BEFORE CUTTING, FACE PLATE & DRIVING ROD
MUST BE FLUSH AT BOTH ENDS



13
PLACE GEAR BETWEEN CORNER TRANSMISSIONS
• Use handle to center in turn position



14
SLIDE FASTENING COVERS IN PLACE OVER GEAR



15
FASTEN GEAR IN PLACE WITH
TYPE "D1" 25-30 mm SCREWS E-12562-XX-0-1

Sash Hardware Prep & Installation - Bottom Mid-Lock

» OPTION FOR WINDOWS WIDER THAN 750 mm
- ADD MID-LOCK AT BOTTOM



**PLACE EXTENSION (CUT TO SIZE IF NECESSARY)
TO CORNER TRANSMISSION AT BOTTOM OF SASH**

- Use G-22385-07-0-1



**SLIDE FASTENING COVER AND FASTEN EXTENSION PLATE IN
PLACE WITH TYPE "D1" 25-30 mm SCREWS E-12562-XX-0-1**

» FOR WINDOWS LOWER THAN 750 mm GO TO **STEP 21**

Sash Hardware Prep & Installation - Hinge Side Mid-Lock

» OPTION FOR WINDOWS HIGHER THAN 750 mm
- ADD MID-LOCK ON VERTICAL

18



HOOK MID-LOCK ONTO EUROGROOVE (AS REQUIRED BY CHART) ON TOP HINGE SIDE OF SASH

- Use 6-32075-XX-0-1



ALIGN SS CLIP WITH INSIDE EUROGROOVE REBATE

- Don't apply excessive force

19

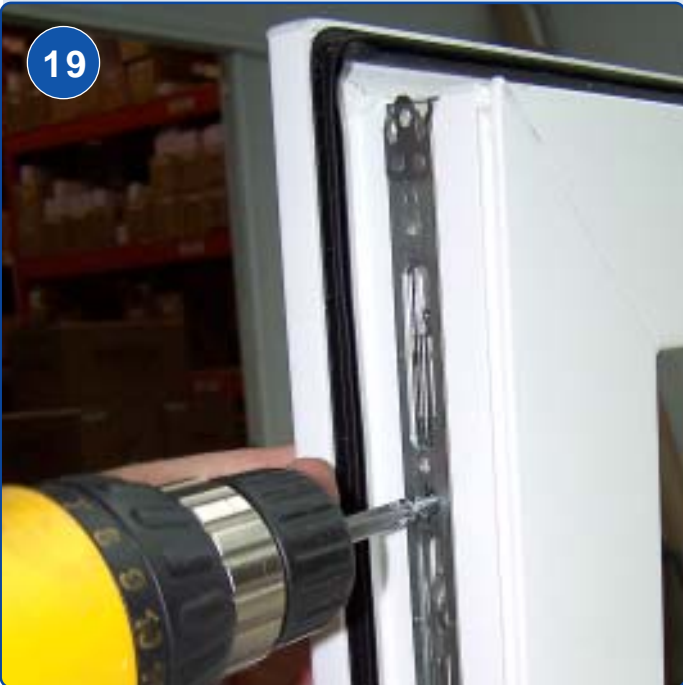

FASTEN MID-LOCK WITH 25-30 mm TYPE "D1" SCREWS E-12562-XX-0-1

20



TEMPORARELY CLIP STAY ARM CONNECTING PLATE ONTO MID-LOCK END AND THEN GO TO **STEP 22**

- Use 6-31512-XX-0-1
- Make sure stud is engaged into SS clip hole

» FOR WINDOWS SMALLER THAN 750 mm GO TO **STEP 21**

Sash Hardware Prep & Installation - Stay Arm



21
TEMPORARELY PLACE AND ALIGN STAY ARM CONNECTING PLATE WITH INSIDE EUROGROOVE REBATE

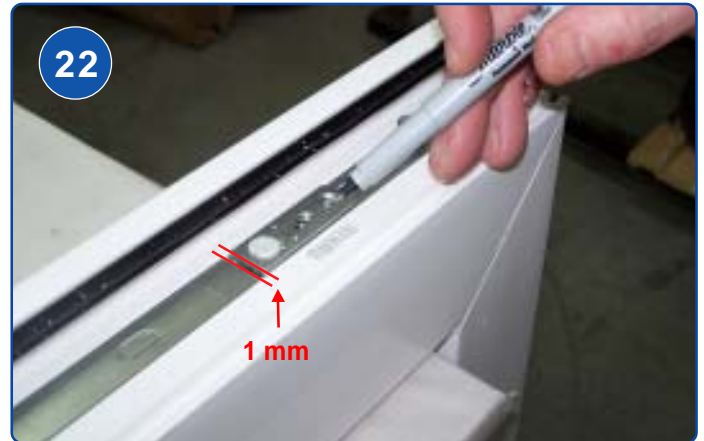

22
MARK CUT OFF POINT 1mm SHORT OF STAY ARM CONNECTING PLATE



23
BEFORE CUTTING, FACE PLATE & DRIVING ROD MUST BE FLUSH AT BOTH ENDS



24
CLIP STAY ARM CONNECTING PLATE ONTO MID-LOCK END OR ALIGN STAY ARM CONNECTING PLATE FLUSH TO CORNER

- Use 6-31512-XX-0-1
- If you use the mid-lock, make sure stud is engaged into SS clip hole

Sash Hardware Prep & Installation - Stay Arm Side



**FASTEN STAY ARM FACE PLATE INTO POSITION
FASTENING SCREW BEHIND CLIP OF STAY ARM FACE PLATE**



**ATTACH END OF STAY ARM (LEFT/RIGHT) TO STAY ARM FACE
PLATE AND CLIP STAY ARM LINK ONTO MOUNT OF STAY ARM
FACE PLATE**

- Use 6-3169X-XX-L/R-1



**LIFT STAY ARM OVER SLIDE CAMS OF FACE PLATE INTO
CLOSED POSITION**

Handle Installation - In "TURN" Mode



- 1 - HANDLE IN CLOSED POSITION
- 2 - HANDLE IN TURN POSITION
- 3 - HANDLE IN TILT POSITION



INSTALL HANDLE ON SASH IN "TURN" MODE

- Lift and turn cover to install handle on sash
- Use 6-28072 (handle)
- Use two M5 X 40 mm screws 9-C5129-40-0-1

Sash Placement



LIFT SASH AND PUSH BOTTOM HINGE SASH BEARING ONTO BOTTOM FRAME BEARING



ALIGN STAY ARM HINGE ONTO TOP HINGE BEARING

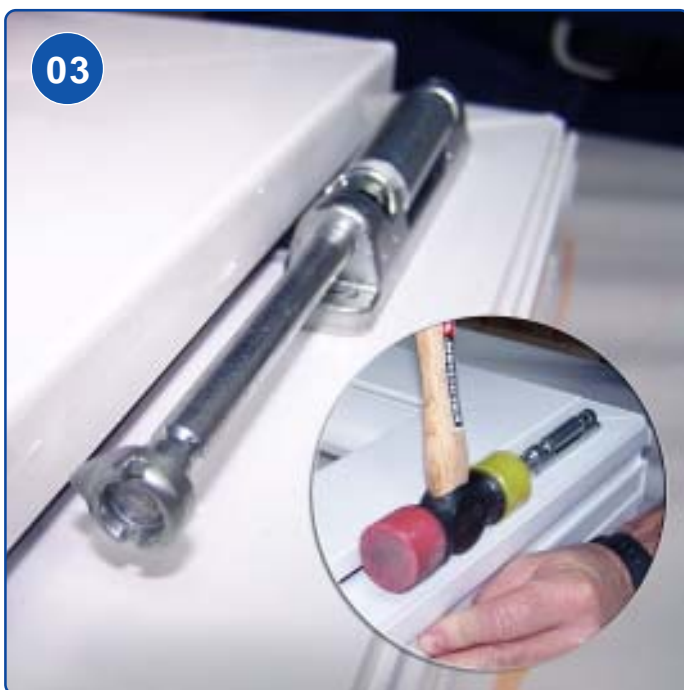

PUSH IN THE PIN INTO TOP HINGE BEARING



USE FLAT SCREW DRIVER TO TURN PIN 90° COUNTER CLOCKWISE TO LOCK OUT POSITION

Keeper installation



TURN HANDLE TO "TILT" MODE TO ACTIVATE THE SYSTEM AND THEN LIFT SASH 2"



PUT SPACER BETWEEN SASH AND FRAME ON HANDLE SIDE FOR EASY ACCESS TO LOCKING CAMS



LOCKING CAM POSITIONS ARE VISIBLE ALL AROUND SASH

Keepers installation

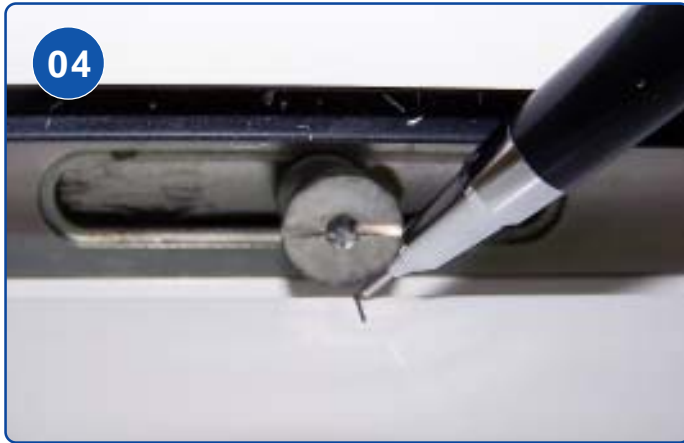

MARK EACH CAM CENTER ON THE FRAME WITH A PENCIL

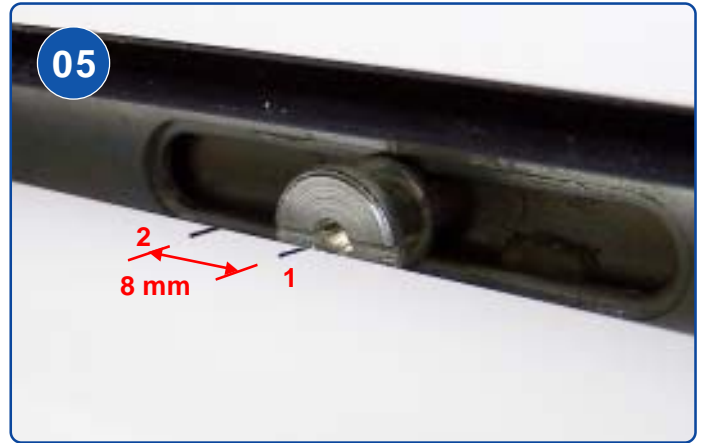

ADD SECOND MARK AT 8 mm OF CENTER MARK

- Clockwise around frame for right handle
- Counterclockwise around frame for left handle



OPEN SASH ON TABLE TO INSTALL KEEPERS AROUND FRAME AND FASTEN WITH TYPE "D1" SCREWS (ALIGN EDGE OF KEEPER AS SHOWN)

- Use 9-35770-00-0-1 (REHAU 730 profile)



LOCKING CAM AND KEEPER ARE IN GOOD POSITIONS

- 1= center cam
- 2= edge of keeper



INSTALL BOTTOM TILT KEEPER AT BOTTOM OF FRAME AND FASTEN WITH TYPE "D1" SCREWS

- Use 6-31067 (REHAU 730 profile)

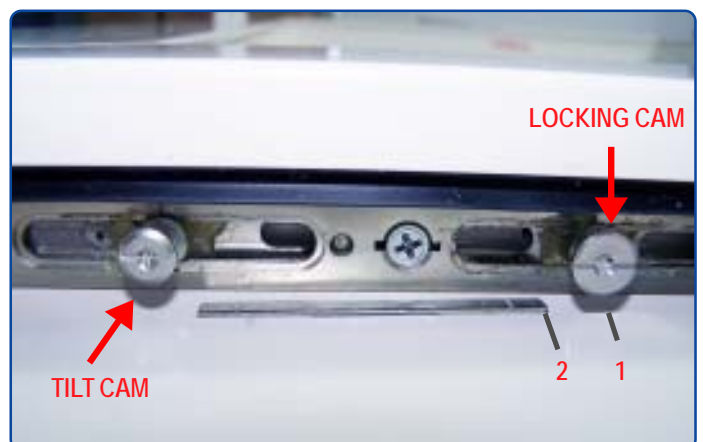

TILT CAM, LOCKING CAM AND BOTTOM TILT KEEPER ARE IN GOOD POSITIONS

Safety Device Installation



INSTALL SAFETY DEVICE IN PRE-SET LOCATION ON GEAR AND FASTEN WITH 38 mm TYPE "D1" SCREW

- Use K-16467-09/13-L/R-1
(only available above 590 mm window height)



ACTIVATE SAFETY DEVICE



COVERS & OPERATION

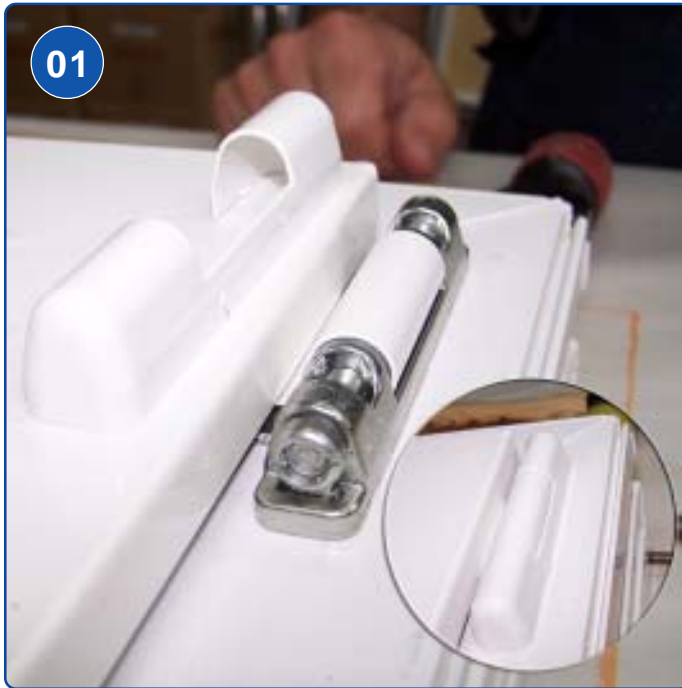

PLACE STAY ARM HINGE AND STAY ARM BEARING COVERS

- Use 9-41695 (Stay arm cover)
- Use 9-41653 (Stay arm bearing cover)



PLACE CORNER BEARING AND HINGE BEARING COVERS

- Use 9-35461-00-0-7 (Corner bearing cover)
- Use 9-35485-00-0-7 (Hinge bearing cover)



CHECK OPERATION OF HARDWARE AND MAKE NECESSARY MINOR ADJUSTMENT

Sash Adjustments - Minor Necessary Adjustments

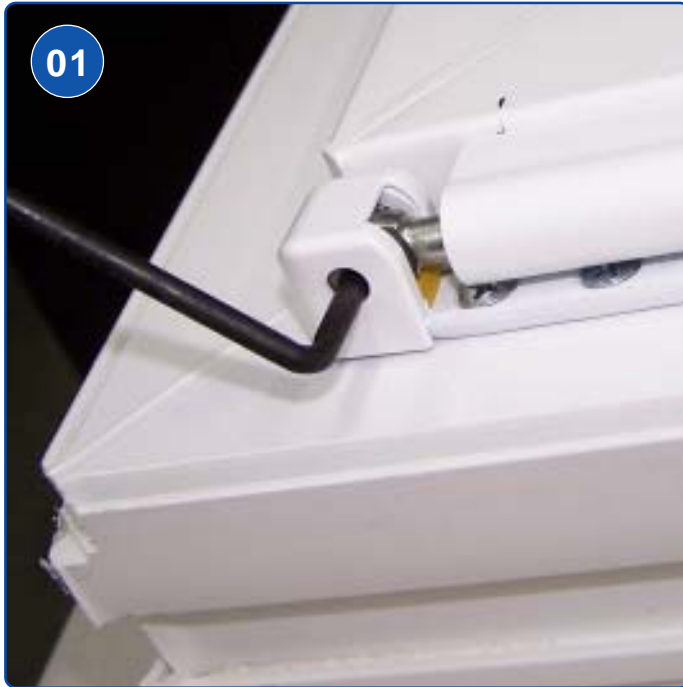

01

LATERAL ADJUSTMENT

- Use torx 15 key H-00890-15-0-0



02

COMPRESSION ADJUSTMENT

- Use torx 15 key H-00890-15-0-0

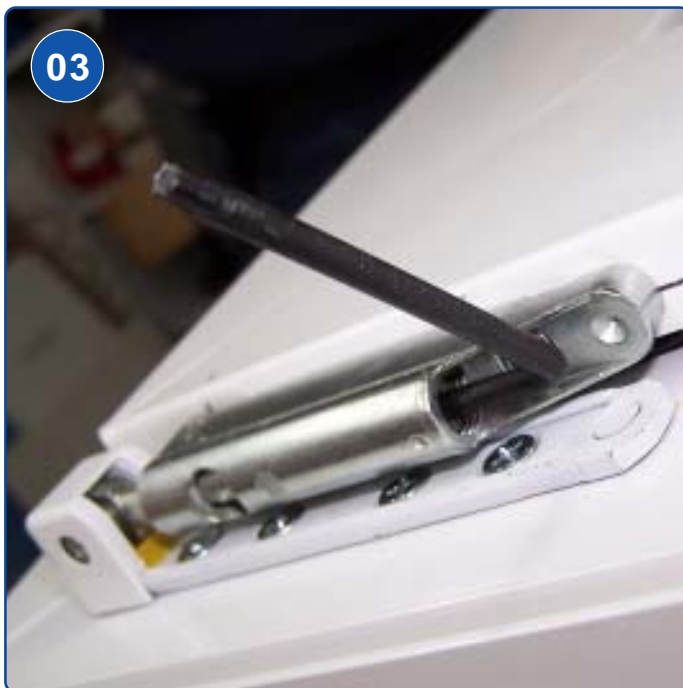

03

HEIGHT ADJUSTMENT

- Use torx 15 key H-00890-15-0-0



04

LATERAL ADJUSTMENT AT TOP OF SASH

- Use torx 15 key H-00890-15-0-0